

FRANKE



**TOOTE
KATALOOG**
2026 • 2027

KATALOOG

2026 • 2027

SEERIAD

Mythos	12
Maris	18
Smart	20

TOOTEKATEGOORIAD

Roostevaba teras	26
Fragraniit	54
Tektoniit	78
Keraamilised	86
Altpoolt monteeritavad valamud	90
Roostevaba teras	94
Fragraniit	112
Tasapinnalised	118
Keraamilised	122
All In	124
Segistid	126
Filtriga segistid	130
Roostevaba teras	134
Kroomitud ja värvilised	150
Seebidosatorid	174
Sorterid	176
Jäätmepurustajad	184
Valamud ja segistid lisad	186
Artiklinumbrite register	194





Aastatepikkune kogemus, kuid endiselt sama uudishimulik kui lapsed

Oleme Frankes otsinud uusi lahendusi ja innovatsioone juba üle 100 aasta ning meie suhtumine pole siiani muutunud. 1911. aastal ühendasime traditsioonilise käsitöö, täppistehnika ja pideva püüdluse innovatsiooni poole – kolm põhimõtet, mis jäävad meie keskmesse.

Šveitsi täpsusega sepistatud lugu

Meie lugu sai alguse eelmise sajandi alguses väikese lehtmetsalläärina Šveitsis Rorschachis, mille asutas Hermann Franke. Sellest ajast alates oleme avanud end maailmale ja avasime tootmisüksused kõikjal maailmas, mis viis meid kõigivalamute alal ja üleüldse kodulahenduste liidriks.



Retsept tervislikumaks tulevikuks

Meie missioon on aidata luua jätkusuutlikum planeet, üks uuendus korraga. Alates jätkusuutlikest materjalidest kuni tõhususe optimeerimiseni ja jäätmete vähendamiseni tegutseme vastutustundlikult kogu oma äritegevuses ja väljaspool seda, et saavutada positiivne pikaajaline mõju.



Keskkonna eest hoolitsemine

Franke liitus ÜRO ülemaailmse kokkuleppega ja adopteeris ÜRO kümme põhimõtet ÜRO ülemaailmse kokkuleppe jätkusuutliku ja vastutustundliku ettevõtluse jaoks 2011. aastal ja on alates sellest ajast aru andnud oma jätkusuutlikkuse mõjude kohta.

Loodame, et 2050. aastaks oleme saavutanud kogu tootmisahelas neto-nullheite taseme ja lokaalsete meetmetega oleme juba eesmärgi saavutamise teel CO2 heitmete kukkumisega 10% aastas alates 2016.

Meie keskkonnateadlik suhtumine ei piirdu heitgaasidega; arendame oma tootmisprotsesse igavesti, et vähendada mõju keskkonnale ja olla eeskujuks.

Ressursid

59% elektritarbimisest 2022. aastal tuli taastuvenergiast, millest 6% tekkis Franke omanduses olevatel objektidel toodetud päikeseenergia abil.

Veetarbimine vähenes 2022. aastal 18,6%.

Franke Grupi maagaasitarbimine vähenes 2022. aastal 17,5%.

Jäätmed

75% 2022. aastal tekkinud jäätmetest taaskasutati.

Pakendamine

Franke on stürofoamist kartongile üle läinud oma graniidist ja tektoniidist valamute pakendamisel. 91% Franke pakenditest on valmistatud taaskasutatavast materjalidest.

Meie inimeste ja ühiskonna toetamine

Meie inimeste ja kogukondade tervis on sama oluline kui meie planeet. Seetõttu pakume oma ettevõttes juhtimiskoolitusi ja eesmärk on teha see 2030. aastaks kättesaadavaks igale töötajale. Samuti teeme koostööd riiklike ja rahvusvaheliste organisatsioonidega, tehes võimalusel vabatahtlikku tööd sotsiaalsete probleemide toetamiseks.

“ Oleme investeerinud rohkem päikeseenergiasüsteemidesse, mis suudavad toota umbes 2 500 000 kWh aastas ”

Innovatsioon jätkusuutlikuks eluks

Meie keskkonnasõbralikud uuendused on loodud selleks, et võimaldada kodus puhtamat elamist ja inspireerida igapäevast heaolu.

Segistid

Roostevabast terasest mudelid on valmistatud 100% taaskasutatavast terasest. Franke Vital Segisti filtreerimissüsteem filtreerib vett otse kraanist, vähendades pudelivee vajadust. Atlas Neo Sensor vähendab vee raiskamist kuni 50% tänu Start/Stop-liikumisandurile.



Valamud

Franke valamute sarjad on jätkusuutlikud materjalide kasutuses, nagu näiteks roostevaba teras. Fragraniit ja keraamika, tagavad toote erakordse vastupidavuse ja pikaajalise kvaliteedi.

Õhupuhastid

Kõik mudelid on loodud energiatarbimise vähendamiseks ja energiatarbimise parandamiseks koos AUTO funktsiooniga. A++ klassi õhupuhastid vähendavad energiatarbimist kuni 85%. Kauakestvaid filtreid ja aktiivsöe keraamilisi filtreid saab regenereerida ja need on loodud jäätmete veelgi vähendamiseks võrreldes tavaliste ühekordselt kasutatavate söefiltritega.



Pliidiplaat õhupuhastiga

Meie õhupuhastid pakuvad maksimaalset energiatarbimist. Näiteks ülivõimas Mythos 2gether õhupuhasti on tänu oma harjadeta mootorile hinnatud parima võimaliku energiatarbimise klassiga A+++.

Ahjud ja mikrolaineahjud

A ja A+ energiaklass, mis pakub eri funktsiooni võimaldades ühe tsükliga erinevaid toite valmistada ja aurupuhastusfunktsiooni, mis võimaldab puhastada kahjulikke kemikaale kasutamata.



Külmkappid

Disainitud külma tsooni kambritega, et toit püsiks kauem värskena. No Frost tehnoloogia, mis aitab vältida sulatamist ja puhkuserežiimiga, mis võimaldab hoida sügavkülmit aktiivsena ka siis, kui jaheosa ei ole.

FRANKE



HOME SOLUTIONS

Lahendused, mis töötavad

Meie köögid on kohad, kus elame: teeme seal süüa, sööme, veedame seal koos aega, sagedamini kui mitte teeme seal neid kõiki kolme korraga. Jälgime põhjalikult oma köögis toimuvaid liikumisi ja töötasime välja lihtsate seadmete asemel korralikud kodulahendused. Kõik meie üksikud tooted sulavad kokku funktsionaalseteks süsteemideks, mille eesmärk on hõlbustada teie elu ja rõõmustada teie silma tänu ideaalselt sobivatele värvidele, disainidele ja kombinatsioonidele. Kui need kõik kokku panna, on iga hetke lihtsam nautida.

Toidu valmistamise alad

Kraanid, valamud ja jäätmekäitlussüsteemid.

Auhinnatud, nutikad ja keskkonnasõbralikud kraanid, mida ideaalselt täiustavad elegantsed, mahukad kausid, mida saab varustada tarvikute või muude nutikate tööriistadega, et teil oleks kõik vajalik alati käepärast. Kõik parimatest, vastupidavamatest ja hügieenilisematest materjalidest, näiteks roostevaba teras või meie eksklusiivsest fragraniiidist.



Kubud

Seina-, lae-, sisseehitatud, saarekubud.

Igal köögil on omad spetsiifilised vajadused, seetõttu lõime kubude valiku, mis üllatab teid tehnoloogia, tõhususe, valgustuse ja kauni disainiga. Avastage saadaolevad värvid, kujundid ja eritehnoloogiad alates sisseehitatud ekraanidest kuni õhupuhastussüsteemideni.

Seadmed

Ahjud, mikrolaineahjud, pliidiplaadid, kohvimasinad, masinad, mikrolaineahjud, külmikud ja nõudepesumasinad.

Oma seadmeid disainides lähtume teie rutiinidest, et saaksime pakkuda funktsionaalseid lahendusi, mis on lihtsasti kasutatavad, nutikate funktsioonidega ja silmale ilusad.



Inspiratsioonid

Miski ei asenda kodu. Ja kahte ühesugust kodu pole olemas. See, kuidas me oma pesa kalliks peame, on täpselt sama ainulaadne kui meie – igaühel on erinevad maitset, eelistused ja vajadused. Et aidata teil saada inspiratsiooni ja luua oma unistuste köögikeskkond ning seda igapäevaselt nautida, töötasime välja kolm erinevat tooteperekonda.

Mythos

Kirg parima vastu

Meie kõige esmaklassilisem valik. Tehnoloogia kohtub disainiga, samas kui ka kõige väiksematele detailidele on tähelepanu pööratud. See seeria seab oma eesmärgi kõrgeimale tasemele, ühendades endas funktsionaalsuse ja ilu.

Maris

Perekond köögis

Perest inspireeritud seeria. Hubane ja funktsionaalne pererahva koosviibimise südantsoojendava kogemuse nautimiseks. Marise filosoofia on lihtne: võtke kõik vastu ja igal ajal omatehtud õhtusöögi uhkuse ja rõõmuga.

Smart

Otse selle juurde, mis on oluline

Kõige lihtsamad asjad toimivad kõige paremini. Oma täiuslikkuses hädavajalik, et jõuda kõige olulisema juurde: teie kööki rõõmu toomine. Seeria, mis on loodud täitma mis tahes vajadusi ja eelistusi.

See, milline teie köök välja näeb, on teie otsustada, kuid olenemata sellest, kuidas te rõõmu oma koju toote, võite meie peale loota.





Valamud:
Mythos Masterpiece - BXM 110-50
Segisti: Eos Neo
Seebidosaatid: Atlas

Mythos



Induksioonpliidite ja õhupuhastite kombinatsioonid:
Mythos 2gether - FMY 839 HI 2.0



Ahjud: Mythos - FMY 99 P XS
Kohvimasin: Mythos - FMY 45 CM XS
Veinikapp: Mythos - FMY 24 WCR XS
Soojendussahtel: Mythos - FMY 14 DRW XS



Hingemattev ilu
ja elegants
toote igas detailis.

Mythos Masterpiece kollektsoon



Ajatu meistriteos



Püsivalt kauni
valamu valem!



„Mythos Masterpiece“ kollektsoon on laienenud – lisaks valamutele, segistitele ja aksessuaaridele kuulub nüüd valikusse ka uus ja stiilne köögi õhupuhasti. See uus toode rõhutab kollektiooni pühendumust kaasaegsele disainile ning esteetilisele harmooniale.

Selle elegants ja rafineeritus muudavad iga köögi inspireerivaks paigaks.

Sobitage
köögielemente
omavahel
või looge
kontraste.

Kolm
erinevat
metalli
tooni

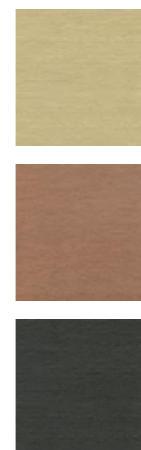



**Loodud
ületamatu
tähelepanuga
detailidele.**

Avastage Mythos meistriteoste kolleksioon





Valamud: Maris Black Collection - MRG 610-72 A
Segisti: Active - väljatõmmatava otsikuga
Seebidosaatorid: Active

Maris



Induktsioonpliidite ja õhupuhasite kombinatsioonid:
Maris 2gether - FMA 839 HI



Ahjud: Maris - FMA 97 PXS
Mikrolaineahi: Maris - FMA 45 MW XS





Valamud: Sirius - S2D 611 - 100
Segisti: Lina

Smart



Õhupuha: Smart Deco - FSMD 508 YL
Induktsioonpliidiplaadid: Smart - FSM 804 I B BK
Ahjud: Smart - FSM 97 P XS
Mikrolaineahi: Smart - FSM 45 MW XS

Näita,

millest sa tehtud oled!

Läikiv või matt, sile või kivitaoline, eriti tugev või ülitrendikas. Teie köök võib teie kohta palju rääkida, nii et iga detail loeb. Et pakkuda teile võimalust luua oma täiuslik köök, on meie materjalivalik loodud nii, et see meeldiks igale maitsele, sobiks iga stiiliga ja seisaks vastu kõikidele püüdlustele. Avastage iga materjali täpselt väljatöötatud iseloom ja ainulaadsed eelised, et valida see, mis vastab teie vajadustele kõige paremini ja mis teile kõige rohkem meeldib.

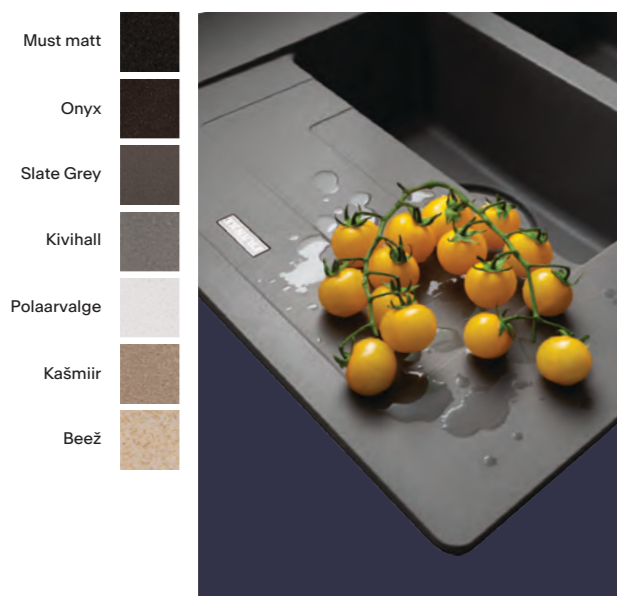

Fragraniit

Erakordselt tugev materjal, mis on väga vastupidav põletustele, mürkidele ja plekkidele. See on ainulaadne materjal, mille on valmistanud Franke, peene läikega, mis on katsudes soe tänu peaaegu 80% kvartslilvale. Pind on peene tekstuuriga, mis tagab kõrged hügieenistandardid.



Roostevaba teras

Ükskõik, kas eelistate poleeritud viimistluse peegeldavaid omadusi, siidise viimistluse peenemat välimust või harjatud viimistlus, mis annab mati läike. Igal juhul on teie jaoks roostevabast terasest lahendus. Kõik Franke roostevabast terasest tooted on valmistatud esmaklassilisest kroomnikelterasest, mis näeb välja vapustav ning on väga vastupidav määrdumisele, roostele ja korrosioonile – lisaks ei purune, ei tuhm, helvestu ega purune. Kui roostevaba teras on köögis üks populaarsemaid materjale, on sellel mõjuv põhjus.

Tektoniit

Kuumus, šokk ja löök ei hirmuta meie Tektoniiti. Tugevus koos ainulaadse disainivabadusega muudab Tektoniit valamud ülimalt valikuks töökasse ja stiilsesse kööki. Uus tehnoloogia kujutab endast hiiglaslikku hüpet sünteetiliste materjalide osas, võimaldades samal ajal põnevaid minimalistlike kujundusi uutes trendikas värvides.



PVD kate

PVD, mis tähendab "füüsiline aurustamine-sadestamine", on kattetehnoloogia, mis muudab segistid veelgi vastupidavamaks hõõrdumisele, kriimustustele ja korrosioonile ning pakub ka erakordseid esteetilisi omadusi. PDV-kattega töödeldud segisti peab isegi UV-kiirgusele vastu ja muudab sõrmejäljed kiires köögis vähem nähtavaks. Saadaval erineva viimistlusega, kusjuures kroom on endiselt kõige populaarsem. Nüüd saadaval hulgaliselt muid suurepäraseid viimistlusi. Tugevast roostevabast terasest, mis ühendab ilu vastupidavusega, messingist kuni tööstusliku musta, vase ja kullani, leiab teie jaoks midagi, mis sobib igasse köögistiili.



F-Inox Tehnoloogia

Eksklusiivne Franke kate, mis suudab rühmitada veemolekule ja võimaldab teil oma valamut kuivatada ilma rõngjate plekkideta. Vett hülgav ja kriimustuskindel, see futuristlik kate ei karda ka kuni 350° kuumust. Tõeline ja kauakestev iluvalem, mida saate hinnata meie Masterpiece'i perekonnalt.

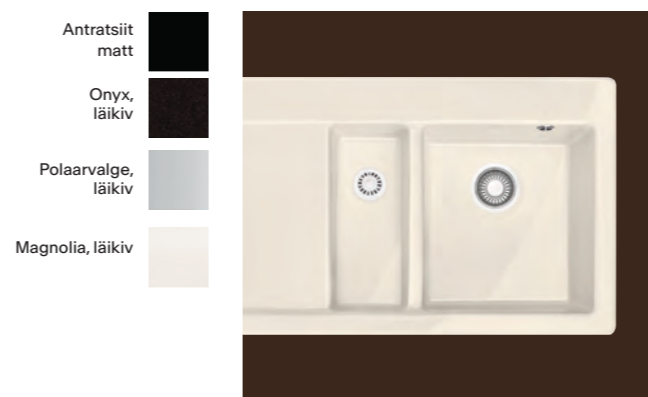

Fraceram

Keraamilistel valamutel on sile, mitteläbilaskev pind, mis talub kergesti kuumust, plekke, lööke ja kõiki tavapäraseid kodusideme vahendeid. Keraamiline valamu on olnud populaarne valik juba aastaid ning loob klassikalise kombinatsiooni erinevate tööpindadega, näiteks puidu, klaasi ja graniidiga.



Teie vajaduste rahuldamine on alati olnud meie pärand.

Ilus ja loodud päriselus kasutamiseks. Teras esindab meie köögiideaali.

Franke toodete puhas kvaliteet on näha ja tunda. Kasutame AISI 304 18/10 terast, mida toodetakse Itaalias ja Euroopas:

valik, mis peegeldab meie pühendumust kvaliteedile, mis on üks meie peamisi prioriteete meie 100-aastase ajaloo jooksul. Tugev ja vastupidav, säilitab see aja jooksul oma sära, muutes selle eluruumide määravaks tunnuseks, kuhu see paigaldatakse. Selle suurepäraseid tehnilised omadused tagavad, et see on alati nõutud ja kõrgelt hinnatud kõrgköögisektori professionaalide seas: lisaks on roostevaba teras äärmiselt hügieeniline materjal, mida on lihtne puhastada ja taaskasutada. Esteetiliselt meeldiv ja funktsionaalne kasutada: roostevaba teras esindab tõesti kvaliteeti säras soomuses.

Klienditeenindus ja Tehniline abi

Valamute ja segistitega seotud probleemidest teavitamiseks esimese 24 kuu jooksul pärast ostmist võtke ühendust hooldusega.

Teenindus

Eliser OÜ

Mustamäe tee 24

(sissepääs maja tagant hoovist Forelli tänava poolt)

EE10621 Tallinn, Estonia

E-R 9:00 - 17.00

+372 6650090

hooldus@eliser.ee

Roostevabast teraseest

valamud



Ülevaade	28
Mythos Masterpiece	31
Mythos	33
Box Centre	35
Box	36
Maris	41
Bell	45
Spark	46
Rapid	51
Antea	52
Ronda	53



Roostevabast

teraseest valamud

80-90 cm

60 cm

50 cm

45 cm

40-30 cm

MYTHOS



Box Centre
BWX 220-54-27 A
35. lk.



Mythos Masterpiece
BXM 210/110-50
31. lk.



Mythos
MYX 210-50
33. lk.



Mythos
MYX 210-45
33. lk.



Mythos Masterpiece
BXM 210/110-40
31. lk.

MARIS



Box
BXX 210/110-68
36. lk.



Maris
MRX 210-70TL
41. lk.



Box
BXX 210/110-54
37. lk.



Box
BXX 210/110-50
37. lk.



Box
BXX 210/110-45
37. lk.



Maris
MRX 210-40TL
41. lk.



Maris
MRX 210-34
44. lk.



Maris
MRX 210-70
46. lk.



Maris
MRX 210-50TL
41. lk.



Maris
MRX 210-50
43. lk.



Box
BXX 210/110-40
38. lk.



Maris
MRX 210-40
44. lk.



Maris
MRX 210-45
43. lk.



Box
BXX 210/110-34
39. lk.



Box
BXX 210/110-16
39. lk.

SMART



Spark
SKX 620-86
50. lk.



Spark
SKX 651
46. lk.



Rapid
RPX 611-86XL
51. lk.



Bell
BCX 610-51
45. lk.



Spark
SKX 621
50. lk.



Antea
AZN 651
52. lk.



Spark
SKX 611-86
47. lk.



Spark
SKN 611-86/44
48. lk.



Spark
SKX 611-62/50
SKL 611-62/50
49. lk.



Spark
SKN 610-37/44
48. lk.



Spark
SKX 611-78/50
47. lk.



Spark
SKN 611-62/44
49. lk.



Ronda
ROX 6101/110-38
53. lk.



Spark
SKN 611-78/44
SKL 611-78/44
47. lk.



Antea
AZN 611-62
52. lk.



Ronda
ROX 610-39
RON 610-39
ROL 610-39
53. lk.

Nurgavalamud



Spark
SKX 651-95E
50. lk.

Mythos Masterpiece



MYTHOS



Mõõdud: **540 x 450 mm**
 Väljalõige: **510 x 420 mm (R = 10 mm)**
 Kausi mõõtmed: **500 /410 /200 mm**
 Paigaldamine: **SlimTop, tasapinnaline või altpoolt**
 Materjal: **F-Inox roostevaba teras**
 Ventiiil: **eksentriline või manuaalne 3/2" ventiiil**
 Ventiiili juhtimine: **ümmargune vajutusnupp (vajalik 35 mm ava tööpinnas) või põhjasõela käsitsi avamine**
 Ülevool: **katteplaadiga ülevool**
 Tööpind: **min 12 mm paksune**

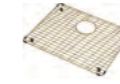

Lisatarvikud, mis kuuluvad komplekti: **Tavaline metallrest valamule, valamu värvid (A1, G1 või C1)**

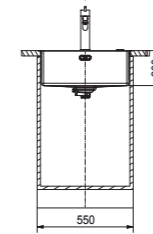
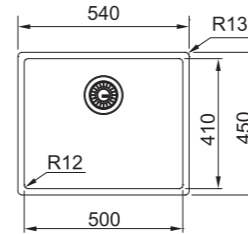

BXM 210/110-50

ümmargune vajutusnupp Hind €

127.0650.363 1447.-
Antratsiit

127.0662.642 1447.-
Vask

127.0662.540 1447.-
Šampanjakuldne

BXM 210/110-50

Manuaalne ventiiil Hind €

127.0672.129 1346.-
Antratsiit

127.0674.363 1346.-
Vask

127.0674.362 1346.-
Šampanjakuldne

Kaasasolevad lisad

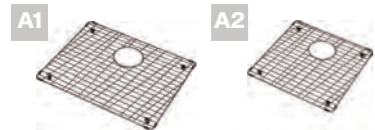

112.0655.470
Tavaline metallrest kraanikausile antratsiit
491 x 401 mm
(50 cm valamud)
203.- €

112.0655.431
Tavaline metallrest kraanikausile antratsiit
391 x 401 mm
(40 cm valamud)
161.- €



112.0655.472
Tavaline metallrest kraanikausile vask
491 x 401 mm
(50 cm valamud)
203.- €

112.0655.468
Tavaline metallrest kraanikausile vask
391 x 401 mm
(40 cm valamud)
161.- €



112.0655.471
Tavaline metallrest kraanikausile šampanjakuldne
491 x 401 mm
(50 cm valamud)
203.- €

112.0655.433
Tavaline metallrest kraanikausile šampanjakuldne
391 x 401 mm
(40 cm valamud)
161.- €

Valikulised lisad

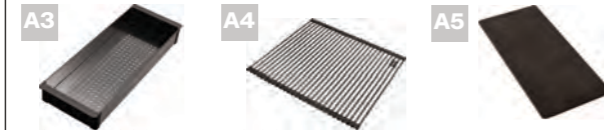

112.0655.239
Nõrutuskauss-roostevaba teras antratsiit plastik käepidemega
157 x 429 x 54 mm
169.- €

112.0655.342
Rullmatt painduv antratsiit
468 x 440 mm
304.- €

112.0676.854
Plastikust lõikepind
240 x 429 x 15 mm
177.- €

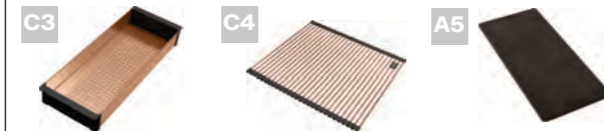

112.0655.341
Nõrutuskauss-roostevaba teras vask plastik käepidemega
157 x 429 x 54 mm
169.- €

112.0655.344
Rullmatt painduv vask
468 x 440 mm
304.- €

112.0676.854
Plastikust lõikepind
240 x 429 x 15 mm
177.- €

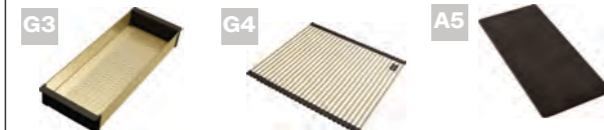

112.0655.240
Nõrutuskauss-roostevaba teras šampanjakuldne plastik käepidemega
157 x 429 x 54 mm
169.- €

112.0655.343
Rullmatt painduv šampanjakuldne
468 x 440 mm
304.- €

112.0676.854
Plastikust lõikepind
240 x 429 x 15 mm
177.- €

Kokkusobivad tooted



Mythos Masterpiece segistid rohkem 135. lk.



Atlas Neo segistid rohkem 143. lk.



Eos Neo segistid rohkem 145. lk.



Atlas Neo Seebidosatorid rohkem 175. lk.

MYTHOS



Mõõdud: **440 x 450 mm**
 Väljalõige: **410 x 420 mm (R = 10 mm)**
 Kausi mõõtmed: **400 /410 /200 mm**
 Paigaldamine: **SlimTop, tasapinnaline või altpoolt**
 Materjal: **F-Inox roostevaba teras**
 Ventiiil: **eksentriline või manuaalne 3/2" ventiiil**
 Ventiiili juhtimine: **ümmargune vajutusnupp (vajalik 35 mm ava tööpinnas) või põhjasõela käsitsi avamine**
 Ülevool: **katteplaadiga ülevool**
 Tööpind: **min 12 mm paksune**

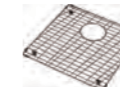

Lisatarvikud, mis kuuluvad komplekti: **Tavaline metallrest valamule, valamu värvid (A2, G2 või C2)**

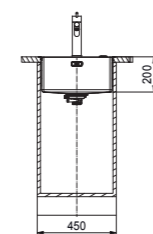
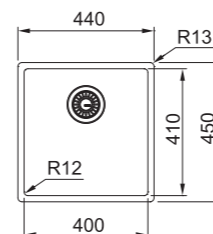

BXM 210/110-40

ümmargune vajutusnupp Hind €

127.0650.362 1350.-
Antratsiit

127.0662.649 1350.-
Vask

127.0662.648 1350.-
Šampanjakuldne

BXM 210/110-50

Manuaalne ventiiil Hind €

127.0674.537 1246.-
Antratsiit

127.0674.583 1246.-
Vask

127.0674.582 1246.-
Šampanjakuldne

Slim Top või tasapinnaline



MYTHOS
01 02
03 04



Mõõdud: **512 x 412 mm**
Väljalõige: **506 x 406 mm (R = 28 mm)**
Kausi mõõtmed: **500 / 400 / 200 mm**
Paigaldamine: **Slim Top või tasapinnaline**
Materjal: **roostevaba teras poleeritud**
Ventiil: **integreeritud ventiil**
Ventiili juhtimine: **vajutusnupp ümmargune roostevaba teras**
(vajaliku tööpinna jaoks on vaja 35 mm auku)
Ventiil kaas: **komplektis ümmarguse metallkattega**
Ülevool: **katteplaadiga ülevool**
Tööpind: **min 12 mm paksune**

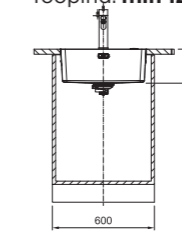
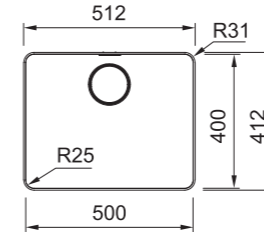

MYX 210-50
ümmargune vajutusnupp Hind €
127.0603.544 770.-
Roostevaba teras

MYTHOS
01 02
03 04



Mõõdud: **462 x 412 mm**
Väljalõige: **456 x 406 mm (R = 28 mm)**
Kausi mõõtmed: **450 / 400 / 200 mm**
Paigaldamine: **Slim Top või tasapinnaline**
Materjal: **roostevaba teras poleeritud**
Ventiil: **integreeritud ventiil**
Ventiili juhtimine: **vajutusnupp ümmargune roostevaba teras**
(vajaliku tööpinna jaoks on vaja 35 mm auku)
Ventiil kaas: **komplektis ümmarguse metallkattega**
Ülevool: **katteplaadiga ülevool**
Tööpind: **min 12 mm paksune**

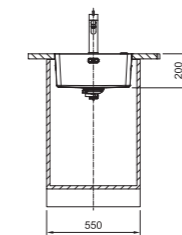
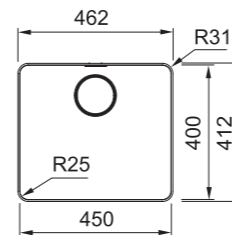

MYX 210-45
ümmargune vajutusnupp Hind €
127.0603.543 741.-
Roostevaba teras

Valikulised lisad



01
112.0591.082
Lõikelaud Paper-
Stone Slate grey
180 x 412 mm
139.- €



02
112.0591.081
Rullmatt painduv
252 x 424 mm
68.- €

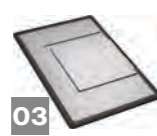

03
112.0602.288
Rv Mobiilne nõruti
plastik raamis
298 x 412 mm
108.- €



04
112.0659.398
Roostevabast terasest
nõrutuskauss
plastikäepidemetega
159 x 416 x 54 mm
66.- €

Kokkusobivad tooted



115.0529.207
Eos Neo U
Roostevabast
terasest segisti
342.- €



115.0728.388
Maris Slim J
Kroom
248.- €



Enne tööpinnale paigaldamist peab järgmistel mudelitel olema ülevooluploki väljalõige:
210-50, MYX 210-45

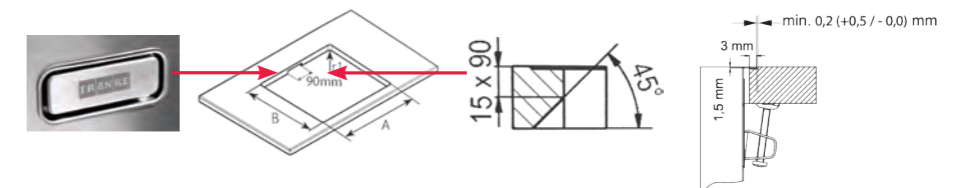

Box Centre

Slim Top või tasapinnaline



MYTHOS

01 02
03 04
05 06
07 08



Möödud: **860 x 510 mm**
 Väljalõige: **840 x 490 mm (R = 10 mm)**
 Kausi mõõtmed:
540 / 410 / 200 + 270 / 480 / 200 mm
 Paigaldamine: **Slim Top või Tasapinnaline**
 Materjal: **roostevaba teras poleeritud**
 Ventii: **3½" ventii**
 Ventii juhtimine: **vajutusnupp ümmargune**
roostevaba teras
 Ülevool: **katteplaadiga ülevool**
 Segisti auk: **segisti ja nupu jaoks 2x 35 mm auk**
 Tööpind: **min 12 mm paksune**
 Sisaldub komplektis: **7 lisa**

BWX 220-54-27 A

Suur kaus paremal



Hind €

127.0558.824 1643.-
 Roostevaba teras

Suur kaus vasakul



127.0558.826 1643.-
 Roostevaba teras

Toode koosneb kahest pakendist (tootenumber all):

- Suur kaus paremal
 127.0558.824 = 127.0543.037 + 112.0544.226
 - Suur kaus vasakul
 127.0558.826 = 127.0543.036 + 112.0544.226

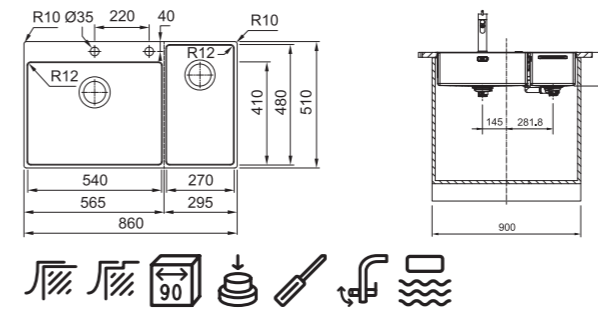

Kaasasolevad lisad



- 01** **112.0539.134**
Puidust lõikelaud
429x180x24mm
- 02** **112.0949.981**
Roostevabast terasest silikoonkäepidemetega kandik
157x429x54mm
- 03** **112.0545.792**
Nugade komplekt
- 04** **112.0539.135**
Pähklipuust noahoidja
- 05** **112.0539.138**
Tarvikute hoiuraam
245x452mm
- 06** **112.0548.292**
Dekoratiivne kate
- 07** **112.0539.120**
Plastist lõikelaud
429x180x24mm

Valikulised lisad

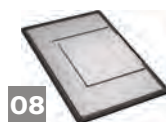

08 **112.0204.360**
Rv Mobiilne nõruti plastik raamis
326x440x22mm
129.- €

Kokkusobivad tooted



115.0625.188
Icon Kroom
479.- €



115.0711.554
Mythos Masterpiece Roostevaba teras
471.- €



Slim Top või tasapinnaline



Valikulised lisad

- | | | | |
|--|--|--|--|
|
01 |
02 |
03 |
04 |
| 112.0080.355
Rollmatt paindub
468 x 440 mm
90.- € | 112.0204.360
Rv Mobiilne nõruti
plastik raamis
326 x 440 x 23 mm
129.- € | 112.0394.981
Roostevabast terasest
nõrutuskauss
plastkäepidemetega
429 x 156 mm
116.- € | 112.0619.946
Andy Chef - tarvikute
komplekt
408 x 133 x 200 mm
493.- € |

Kokkusobivad tooted

- | | |
|--|--|
|
115.0521.438
Atlas Neo
Roostevabast
terasest segisti
324.- € |
115.0728.388
Maris Slim J
Kroom
248.- € |
|--|--|

MARIS



Mõõdud: **725 x 450 mm**
 Väljalõige: **695 x 420 mm (R = 10 mm)**
 Kausi mõõtmed: **685 / 410 / 200 mm**
 Paigaldamine: **SlimTop, tasapinnaline või altpoolt**
 Ventiiil: **integreeritud või 3½" ventiiil**
 Ventiiili juhtimine: **vajutusnupp ümmargune roostevaba teras**
 Nupu kasutamiseks on vaja 35 mm auku
 Ülevool: **katteplaadiga ülevool**
 Tööpind: **min 12 mm paksune**

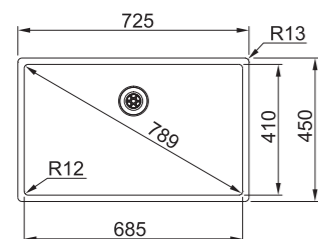

BXX 210/110-68

Valamu põhjaga integreeritud ekstsentrilapiga valamu, mida juhitakse nupuga. Hind €

127.0539.907 548.-
 Roostevaba teras

Valamu käsitsi ventiiiliga, mida saab tõsta/langetada manuaalselt. Täienduste hulgas on ka jäätmepurustusmasinad. Hind €

127.0539.906 496.-
 Roostevaba teras

MARIS



Mõõdud: **540 x 450 mm**
 Väljalõige: **510 x 420 mm (R = 10 mm)**
 Kausi mõõtmed: **500 / 410 / 200 mm**
 Paigaldamine: **SlimTop, tasapinnaline või altpoolt**
 Ventiiil: **integreeritud või 3½" ventiiil**
 Ventiiili juhtimine: **vajutusnupp ümmargune roostevaba teras**
 Nupu kasutamiseks on vaja 35 mm auku
 Ülevool: **katteplaadiga ülevool**
 Tööpind: **min 12 mm paksune**

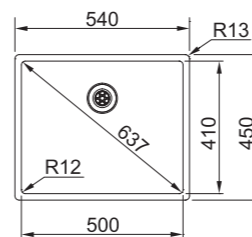

BXX 210/110-50

Valamu põhjaga integreeritud ekstsentrilapiga valamu, mida juhitakse nupuga. Hind €

127.0375.273 473.-
 Roostevaba teras

Valamu käsitsi ventiiiliga, mida saab tõsta/langetada manuaalselt. Täienduste hulgas on ka jäätmepurustusmasinad. Hind €

127.0374.206 415.-
 Roostevaba teras

MARIS



Mõõdud: **490 x 450 mm**
 Väljalõige: **460 x 420 mm (R = 10 mm)**
 Kausi mõõtmed: **450 / 410 / 200 mm**
 Paigaldamine: **SlimTop, tasapinnaline või altpoolt**
 Ventiiil: **integreeritud või 3½" ventiiil**
 Ventiiili juhtimine: **vajutusnupp ümmargune roostevaba teras**
 Nupu kasutamiseks on vaja 35 mm auku
 Ülevool: **katteplaadiga ülevool**
 Tööpind: **min 12 mm paksune**

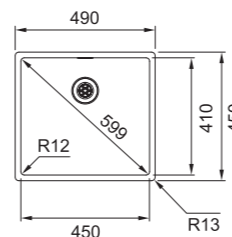

BXX 210/110-45

Valamu põhjaga integreeritud ekstsentrilapiga valamu, mida juhitakse nupuga. Hind €

127.0375.257 455.-
 Roostevaba teras

Valamu käsitsi ventiiiliga, mida saab tõsta/langetada manuaalselt. Täienduste hulgas on ka jäätmepurustusmasinad. Hind €

127.0372.489 399.-
 Roostevaba teras

Slim Top või tasapinnaline



Valikulised lisad

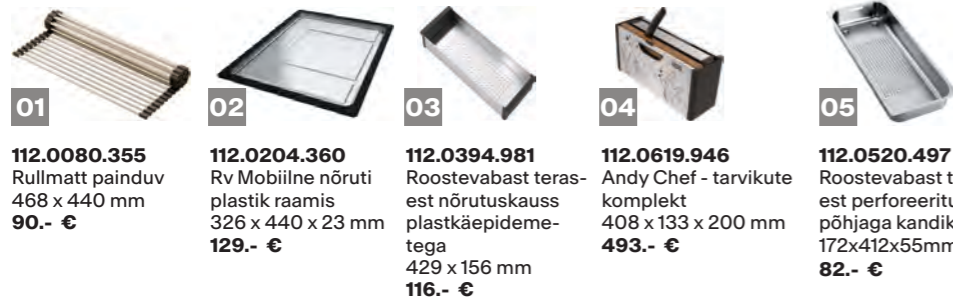

- 01** 112.0080.355 Rullmatt paindub 468 x 440 mm 90.- €
- 02** 112.0204.360 Rv Mobiilne nõruti plastik raamis 326 x 440 x 23 mm 129.- €
- 03** 112.0394.981 Roostevabast terasest nõrutuskauss plastkäepidemetega 429 x 156 mm 116.- €
- 04** 112.0619.946 Andy Chef - tarvikute komplekt 408 x 133 x 200 mm 493.- €
- 05** 112.0520.497 Roostevabast terasest perforeeritud põhjaga kandik 172x412x55mm 82.- €

Kokkusobivad tooted

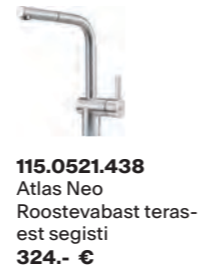

- 115.0521.438** Atlas Neo Roostevabast terasest segisti 324.- €

MARIS



Mõõdud: **440 x 450 mm**
 Väljalõige: **410 x 420 mm (R = 10 mm)**
 Kausi mõõtmed: **400 /410 /200 mm**
 Paigaldamine: **SlimTop, tasapinnaline või altpoolt**
 Ventiiil: **integreeritud või 3½" ventiiil**
 Ventiiili juhtimine: **vajutusnupp ümmargune roostevaba teras**
 Nupu kasutamiseks on vaja 35 mm auku
 Ülevool: **katteplaadiga ülevool**
 Tööpind: **min 12 mm paksune**

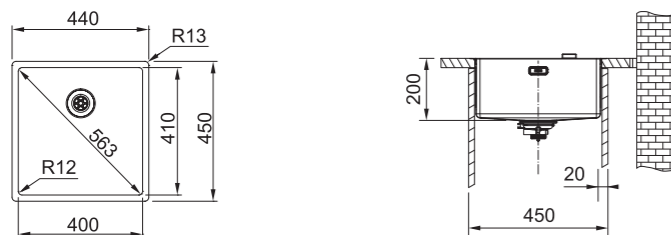

BXX 210/110-40

Valamu põhjaga integreeritud ekstsentrilapiga valamu, mida juhitakse nupuga. Hind €

127.0375.252 445.-
 Roostevaba teras

Valamu käsitsi ventiiiliga, mida saab tõsta/langutada manuaalselt. Täienduste hulgas on ka jäätmepurustusmasinad. Hind €

127.0375.284 387.-
 Roostevaba teras

MARIS



Mõõdud: **380 x 450 mm**
 Väljalõige: **350 x 420 mm (R = 10 mm)**
 Kausi mõõtmed: **340 /410 /200 mm**
 Paigaldamine: **SlimTop, tasapinnaline või altpoolt**
 Ventiiil: **integreeritud või 3½" ventiiil**
 Ventiiili juhtimine: **vajutusnupp ümmargune roostevaba teras**
 Nupu kasutamiseks on vaja 35 mm auku
 Ülevool: **katteplaadiga ülevool**
 Tööpind: **min 12 mm paksune**

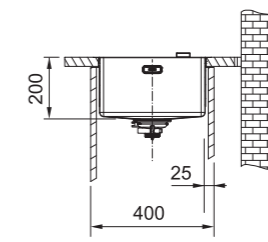
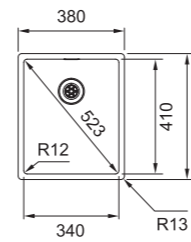

BXX 210/110-34

Valamu põhjaga integreeritud ekstsentrilapiga valamu, mida juhitakse nupuga. Hind €

127.0374.687 435.-
 Roostevaba teras

Valamu käsitsi ventiiiliga, mida saab tõsta/langutada manuaalselt. Täienduste hulgas on ka jäätmepurustusmasinad. Hind €

127.0372.501 370.-
 Roostevaba teras

MARIS



Mõõdud: **200 x 450 mm**
 Väljalõige: **170 x 420 mm (R = 10 mm)**
 Kausi mõõtmed: **160 /410 /200 mm**
 Paigaldamine: **SlimTop, tasapinnaline või altpoolt**
 Ventiiil: **integreeritud ventiiil**
 Ventiiili juhtimine: **vajutusnupp ümmargune roostevaba teras**
 Nupu kasutamiseks on vaja 35 mm auku
 Ülevool: **katteplaadiga ülevool**
 Tööpind: **min 12 mm paksune**

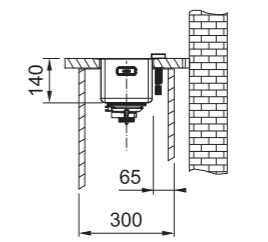
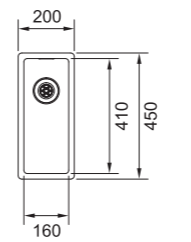

BXX 210/110-16

Valamu põhjaga integreeritud ekstsentrilapiga valamu, mida juhitakse nupuga. Hind €

127.0374.673 427.-
 Roostevaba teras

Andy Chef



Enne paigaldamist peab tööpinna olema väljalõige ülevoolu paigaldamiseks.



Slim Top või tasapinnaline



Valikulised lisad

- 01**



112.0520.497
Roostevabast terasest perforeeritud põhjaga kandik
172x412x55mm
82.- €
- 02**



112.0030.882
Rullmatt painduv
468 x 420 mm
86.- €
- 03**



112.0188.651
Rv Mobiilne nõruti plastik raamis
342 x 430 x 22 mm
120.- €
- 04**



ALL-IN
5 erinevat komplekti ALL IN (rohkem lk 125) valamule:
340 x 540 mm
135.- ... 258.- €



Kokkusobivad tooted

- 

115.0521.438
Atlas Neo
Roostevabast terasest segisti
324.- €
- 

115.0728.388
Maris Slim J
Kroom
248.- €

MARIS
01 02
03 04



Mõõdud: **730 x 510 mm**
Väljalõige: **710 x 490 mm (R=10mm)**
Kausi mõõtmed: **700/400/180 mm**
Paigaldamine: **Slim Top või tasapinnaline**
Materjal: **roostevaba teras poleeritud**
Ventiiil: **manuaalne 3½" ventiiil**
Ventiiili juhtimine: **käsitsi avamine/ sulgemine**
Ülevool: **katteplaadiga ülevool**
Segisti auk: **35 mm auk**

MRX 210-70TL
Manuaalne ventiiil Hind €
127.0531.917 **512.-**
Roostevaba teras

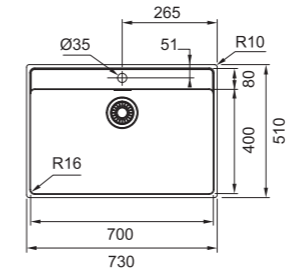

MARIS
01 02
03 04



Mõõdud: **530 x 510 mm**
Väljalõige: **510 x 490 mm (R = 10 mm)**
Kausi mõõtmed: **500 /400 /180 mm**
Paigaldamine: **Slim Top või tasapinnaline**
Materjal: **roostevaba teras poleeritud**
Ventiiil: **manuaalne 3½" ventiiil**
Ventiiili juhtimine: **käsitsi avamine/ sulgemine**
Ülevool: **katteplaadiga ülevool**
Segisti auk: **35 mm auk**

MRX 210-50TL
Manuaalne ventiiil Hind €
127.0531.852 **377.-**
Roostevaba teras

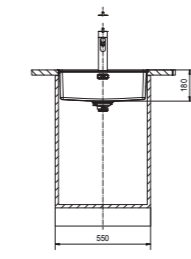
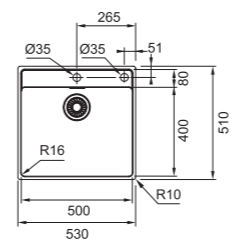

MARIS
01 02
03 04



Mõõdud: **430 x 510 mm**
Väljalõige: **410 x 490 mm (R = 10 mm)**
Kausi mõõtmed: **400 /400 /180 mm**
Paigaldamine: **Slim Top või tasapinnaline**
Materjal: **roostevaba teras poleeritud**
Ventiiil: **manuaalne 3½" ventiiil**
Ventiiili juhtimine: **käsitsi avamine/ sulgemine**
Ülevool: **katteplaadiga ülevool**
Segisti auk: **35 mm auk**

MRX 210-40TL
Manuaalne ventiiil Hind €
127.0531.851 **352.-**
Roostevaba teras

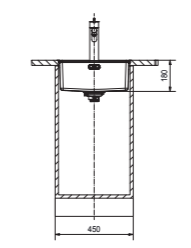
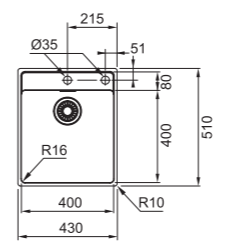

Slim Top või tasapinnaline



Valikulised lisad

- 01**



112.0520.497
Roostevabast terasest perforeeritud põhjaga kandik
172x412x55mm
82.- €
- 02**



112.0030.882
Rullmatt painduv
468 x 420 mm
86.- €
- 03**



112.0188.651
Rv Mobiilne nõruti plastik raamis
342 x 430 x 22 mm
120.- €
- 04**



ALL-IN
5 erinevat komplekti ALL IN (rohkem lk 125) valamule:
340 x 540 mm
135.- ... 258.- €

Kokkusobivad tooted

- 115.0521.438**
Atlas Neo
Roostevabast terasest segisti
324.- €
- 115.0728.388**
Maris Slim J
Kroom
248.- €

MARIS



Mõõdud: **740 x 440 mm**
Kausi mõõtmed: **500 /400 /180 mm**
Paigaldamine: **Slim Top või tasapinnaline**
Materjal: **roostevaba teras poleeritud**
Ventii: **manuaalne 3½" ventiil**
Ventii juhtimine: **käsitsi avamine/ sulgemine**
Ülevool: **katteplaadiga ülevool**
Segisti auk: **ei**

MRX 210-70

Manuaalne ventiil
Hind €
127.0531.916 **411.-**
Roostevaba teras

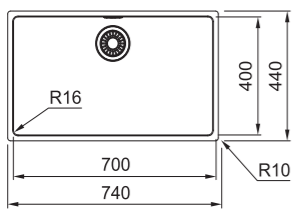

MARIS



Mõõdud: **590 x 440 mm**
Kausi mõõtmed: **550 /400 /180 mm**
Paigaldamine: **Slim Top või tasapinnaline**
Materjal: **roostevaba teras poleeritud**
Ventii: **manuaalne 3½" ventiil**
Ventii juhtimine: **käsitsi avamine/ sulgemine**
Ülevool: **katteplaadiga ülevool**
Segisti auk: **ei**

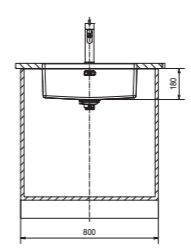
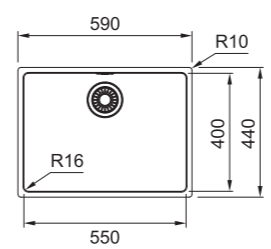

MRX 210-55

Manuaalne ventiil
Hind €
127.0553.962 **366.-**
Roostevaba teras

MARIS



Mõõdud: **540 x 440 mm**
Kausi mõõtmed: **500 /400 /180 mm**
Paigaldamine: **Slim Top või tasapinnaline**
Materjal: **roostevaba teras poleeritud**
Ventii: **manuaalne 3½" ventiil**
Ventii juhtimine: **käsitsi avamine/ sulgemine**
Ülevool: **katteplaadiga ülevool**
Segisti auk: **ei**

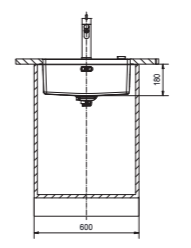
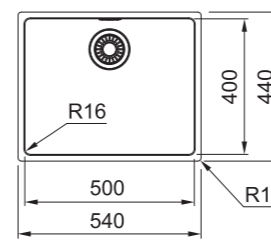

MRX 210-50

Manuaalne ventiil
Hind €
127.0531.810 **352.-**
Roostevaba teras

MARIS



Mõõdud: **490 x 440 mm**
Kausi mõõtmed: **500 /400 /180 mm**
Paigaldamine: **Slim Top või tasapinnaline**
Materjal: **roostevaba teras poleeritud**
Ventii: **manuaalne 3½" ventiil**
Ventii juhtimine: **käsitsi avamine/ sulgemine**
Ülevool: **katteplaadiga ülevool**
Segisti auk: **ei**

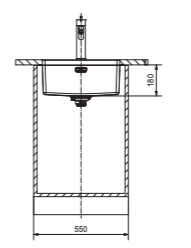
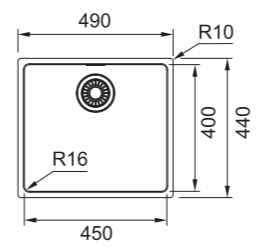

MRX 210-45

Manuaalne ventiil
Hind €
127.0553.961 **338.-**
Roostevaba teras

Maris

Slim Top või tasapinnaline

Valikulised lisad

01  **112.0520.497**
Roostevabast terasest perforeeritud põhjaga kandik 172x412x55mm
82.- €

02  **112.0030.882**
Rullmatt paindub 468 x 420 mm
86.- €

03  **112.0188.651**
Rv Mobiilne nõruti plastik raamis 342 x 430 x 22 mm
120.- €

04  **ALL-IN**
5 erinevat komplekti ALL IN (rohkem lk 125) valamule: 340 x 540 mm
135.- ... 258.- €

Kokkusobivad tooted

 **115.0521.438**
Atlas Neo Roostevabast terasest segisti
324.- €

 **115.0728.388**
Maris Slim J Kroom
248.- €

MARIS



Mõõdud: **440 x 440 mm**
Kausi mõõtmed: **400 /400 /180 mm**
Paigaldamine: **Slim Top või tasapinnaline**
Materjal: **roostevaba teras poleeritud**
Ventii: **manuaalne 3½" ventii**
Ventii juhtimine: **käsitsi avamine/ sulgemine**
Ülevool: **katteplaadiga ülevool**
Segisti auk: **ei**

MRX 210-40

Manuaalne ventii Hind €
127.0531.809 **324.-**
Roostevaba teras



Valikulised lisad

01  **ALL-IN**
5 erinevat komplekti ALL IN (rohkem lk 125) valamule: 340 x 540 mm
135.- ... 258.- €

Kokkusobivad tooted

 **115.0569.290**
Orbit Roostevaba teras
149.- €

 **115.0706.985**
Glenda Roostevaba teras
173.- €

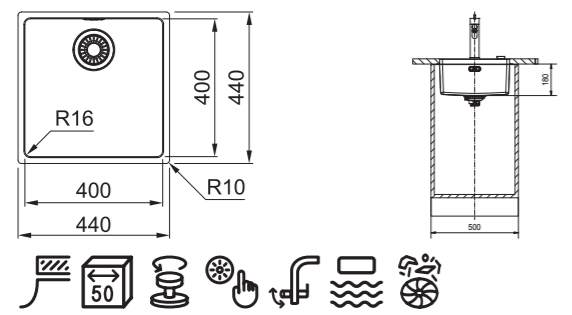

MARIS



Mõõdud: **380 x 440 mm**
Kausi mõõtmed: **340 /400 /180 mm**
Paigaldamine: **Slim Top või tasapinnaline**
Materjal: **roostevaba teras poleeritud**
Ventii: **manuaalne 3½" ventii**
Ventii juhtimine: **käsitsi avamine/ sulgemine**
Ülevool: **katteplaadiga ülevool**
Segisti auk: **ei**

MRX 210-34

Manuaalne ventii Hind €
127.0531.915 **312.-**
Roostevaba teras

SMART



Mõõdud: **510 x 510 mm**
Väljalõige: **490 x 490 mm**
Kausi mõõtmed: **445 /380 /200 mm**
Paigaldamine: **süvistatav**
Materjal: **roostevaba teras poleeritud**
Ventii: **manuaalne ventii 3½"**
Ventii juhtimine: **põhjasõela käsitsi avamine**
Segisti auk: **35 mm auk**

BCX 610-51

Manuaalne ventii Hind €
101.0622.893 **139.-**
Roostevaba teras

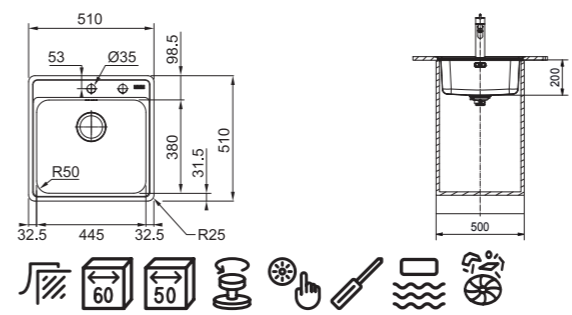
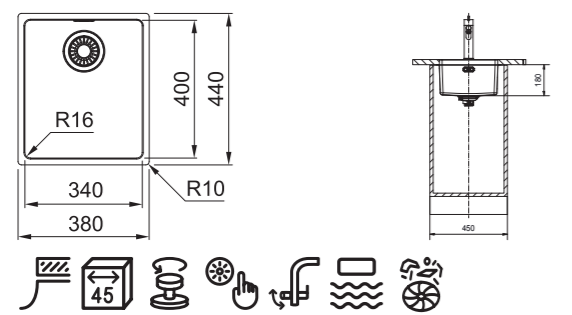



Kaasolevad lisad



01

112.0461.942
Roostevabast terasest
nõrutuskauss
297 x 187 x 72 mm
45.- €

Valikulised lisad



02

112.0595.334
Puidust lõikelaud
532 x 280 mm
80.- €



03

ALL-IN
5 erinevat komplekti ALL IN
(rohkem lk 125) valamule:
340 x 540 mm
135.- ... 258.- €

Kokkusobivad tooted



115.0728.473
Lina U
Kroom
145.- €



115.0706.985
Glenda
Roostevaba teras
173.- €

SMART



Mõõdud: **1000 x 500 mm**
Väljalõige: **980 x 480 mm (R = 10 mm)**
Kausi mõõtmed: **340 / 420 / 160 + 170 / 280 / 80 mm**
Kausi asukoht: **pööratav**
Paigaldamine: **süvistatav**
Materjal: **roostevaba teras poleeritud**
Ventiil: **nupuga avatav 3½" ventiil**
Ventiili juhtimine: **keeratav nupp**
Segisti auk: **segisti ja nupu jaoks 2x 35 mm auk**
Tööpind: **min 30 mm paksune**
Komplekt sisaldab: **Roostevabast terasest nõrutuskauss 112.0461.942**

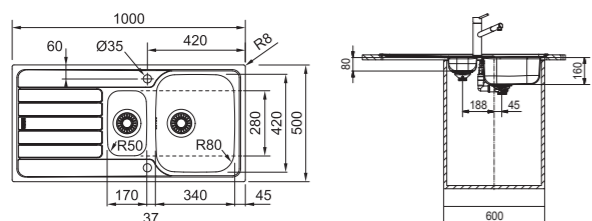

SKX 651

Nupuga avatav
Hind €
101.0464.044 209.-
Roostevaba teras

SMART



Mõõdud: **780 x 435 mm**
Väljalõige: **760 x 415 mm (R = 10 mm)**
Kausi mõõtmed: **340 / 370 / 150 mm**
Kausi asukoht: **pööratav**
Paigaldamine: **süvistatav**
Materjal: **roostevaba teras**
Ventiil: **manuaalne 3½" ventiil**
Ventiili juhtimine: **põhjasõela käsitsi avamine**
Segisti auk: **ei**
Tööpind: **min 30 mm paksune**

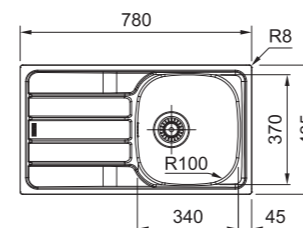

SKX 611-86

Nupuga avatav
Hind €
101.0464.337 149.-
Roostevaba teras



Mõõdud: **860 x 500 mm**
Väljalõige: **840 x 480 mm (R = 10 mm)**
Kausi mõõtmed: **340 / 420 / 160 mm**
Kausi asukoht: **pööratav**
Paigaldamine: **süvistatav**
Materjal: **roostevaba teras poleeritud**
Ventiil: **nupuga avatav 3½" ventiil**
Ventiili juhtimine: **keeratav nupp**
Segisti auk: **segisti ja nupu jaoks 2x 35 mm auk**
Tööpind: **min 30 mm paksune**

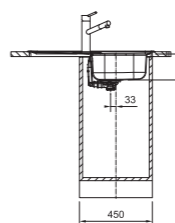
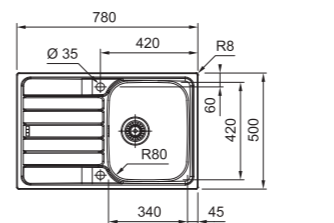

SKX 611-78/50

Nupuga avatav
Hind €
101.0714.945 139.-
Roostevaba teras



Mõõdud: **780 x 500 mm**
Kausi mõõtmed: **340 / 420 / 160 mm**
Kausi asukoht: **pööratav**
Paigaldamine: **süvistatav**
Materjal: **roostevaba teras poleeritud**
Ventiil: **nupuga avatav 3½" ventiil**
Ventiili juhtimine: **keeratav nupp**
Segisti auk: **segisti ja nupu jaoks 2x 35 mm auk**
Tööpind: **min 30 mm paksune**

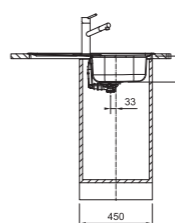
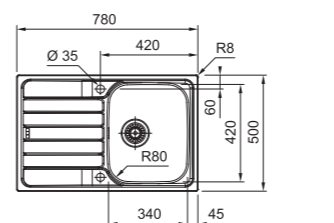

SKN 611-78/44

Manuaalne ventiil
Hind €
101.0729.490 108.-
Roostevaba teras

SKL 611-78/44

Manuaalne ventiil
Hind €
101.0729.492 120.-
Roostevaba teras
linane



Valikulised lisad



01
112.0595.334
Puidust lõikelaud
532 x 280 mm
80.- €

02
ALL-IN
5 erinevat komplekti ALL IN
(rohkem lk 125) valamule:
340 x 540 mm
135.- ... 258.- €

Kokkusobivad tooted



115.0728.473
Lina U
Kroom
145.- €

115.0706.985
Glenda
Roostevaba teras
173.- €

SMART



Modelis: **SKN 611-86/44**
Aluskapp: 45 cm
Mõõdud: **860 x 435 mm**
Väljalõige: **840 x 415 mm (R = 10 mm)**
Kausi mõõtmed: **340 / 370 / 150 mm**
Kausi asukoht: **pööratav**
Paigaldamine: **süvistatav**
Materjal: **roostevaba teras**
Ventil: **manuaalne 3½" ventiil**
Ventili juhtimine: **põhjasõela käsitsi avamine**
Segisti auk: **ei**
Tööpind: **min 30 mm paksune**

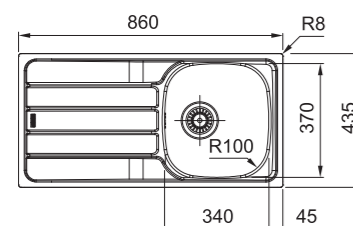

SKN 611-86/44
Manuaalne ventiil
Hind €
101.0729.489 112.-
Roostevaba teras

SMART



Mõõdud: **455 x 435 mm**
Väljalõige: **435 x 415 mm (R = 10 mm)**
Kausi mõõtmed: **370 / 340 / 150 mm**
Materjal: **roostevaba teras**
Paigaldamine: **süvistatav**
Ventil: **manuaalne 3½" ventiil**
Ventili juhtimine: **põhjasõela käsitsi avamine**
Segisti auk: **ei**
Tööpind: **min 30 mm paksune**

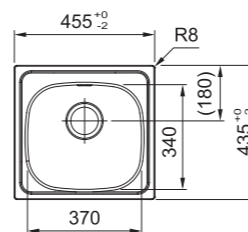

SKX 611-62/50
Nupuga avatav
Hind €
101.0714.948 143.-
Roostevaba teras

SKL 611-62/50
Nupuga avatav
Hind €
101.0729.488 139.-
Roostevaba teras
linane

SKN 611-62/44
Manuaalne ventiil
Hind €
101.0729.493 100.-
Roostevaba teras

SKN 610-37/44
Manuaalne ventiil
Hind €
101.0714.957 90.-
Roostevaba teras

SMART



Mõõdud: **620 x 500 mm**
Väljalõige: **600 x 480 mm (R = 10 mm)**
Kausi mõõtmed: **340 / 420 / 160 mm**
Kausi asukoht: **pööratav**
Materjal: **roostevaba teras**
Paigaldamine: **süvistatav**
Ventil: **nupuga avatav 3½" ventiil**
Ventili juhtimine: **keeratav nupp**
Segisti auk: **segisti ja nupu jaoks 2x 35 mm auk**
Tööpind: **min 30 mm paksune**

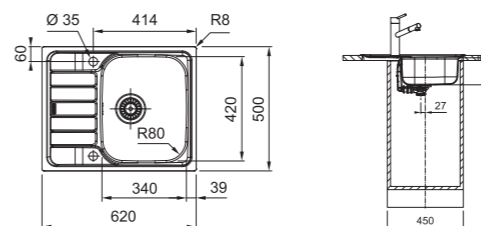

SMART

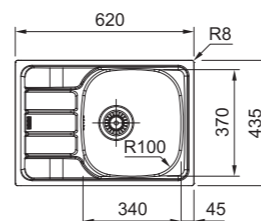

Spark

SMART

01 02



Mõõdud: **860 x 500 mm**
 Väljalõige: **840 x 480 mm (R = 10 mm)**
 Kausi mõõtmed: **2x 339 / 409 / 155 mm**
 Kausi asukoht: **pööratav**
 Paigaldamine: **süvistatav**
 Ventii: **nupuga avatav 3½" ventii**
 Ventii juhtimine: **keeratav nupp**
 Segisti auk: **segisti ja nupu jaoks 2x 35 mm auk**
 Tööpind: **min 30 mm paksune**

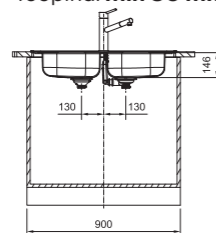
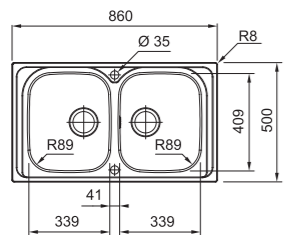

SKX 620-86

Nupuga avatav

Hind €

101.0714.950 **189.-**
 Roostevaba teras

SMART

01 02



Mõõdud: **1160 x 500 mm**
 Väljalõige: **1140 x 480 mm (R = 10 mm)**
 Kausi mõõtmed: **2x 340 / 420 / 155 mm**
 Kausi asukoht: **pööratav**
 Materjal: **roostevaba teras poleeritud**
 Paigaldamine: **süvistatav**
 Ventii: **nupuga avatav 3½" ventii**
 Ventii juhtimine: **keeratav nupp**
 Segisti auk: **segisti ja nupu jaoks 2x 35 mm auk**
 Tööpind: **min 30 mm paksune**

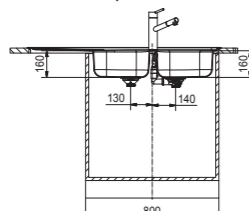
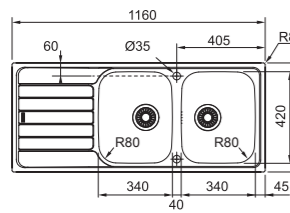

SKX 621

Nupuga avatav

Hind €

101.0469.740 **219.-**
 Roostevaba teras

SMART

02 03



Mõõdud: **945 x 510 mm**
 Väljalõige: **Šablooni järgi**
 Kausi mõõtmed: **339 / 419 / 150 + 233 / 253 / 80 mm**
 Paigaldamine: **süvistatav**
 Materjal: **roostevaba teras poleeritud**
 Ventii: **nupuga avatav 3½" ventii**
 Ventii juhtimine: **keeratav nupp**
 Segisti auk: **segisti ja nupu jaoks 2x 35 mm auk**
 Tööpind: **min 30 mm paksune**

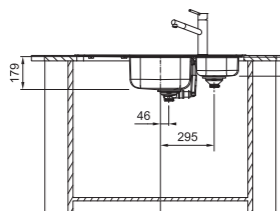
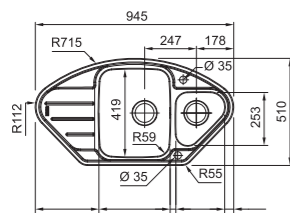

SKX 651-95-E

Nupuga avatav

Hind €

101.0714.951 **260.-**
 Roostevaba teras

Rapid

Süvistatav



Valikulised lisad



01

112.0595.334
 Puidust lõikelaud
 532 x 280 mm
80.- €



02

ALL-IN
 5 erinevat komplekti ALL IN
 (rohkem lk 125) valamule:
 340 x 540 mm
135.- ... 258.- €



03

112.0006.138
 Roostevabast terasest
 nõrutuskauss
 200 x 265 x 70 mm
33.- €

Kokkusobivad tooted



115.0569.290
 Orbit
 Roostevaba teras
149.- €



115.0706.985
 Glenda
 Roostevaba teras
173.- €

SMART

01 02



Mõõdud: **860 x 500 mm**
 Väljalõige: **840 x 480 mm (R = 20 mm)**
 Kausi mõõtmed: **450 / 400 / 200 mm**
 Kausi asukoht: **pööratav**
 Paigaldamine: **süvistatav**
 Materjal: **roostevaba teras poleeritud**
 Ventii: **nupuga avatav 3½" ventii**
 Ventii juhtimine: **PopUp keeratav nupp**
 Ülevool: **katteplaadiga ülevool**
 Segisti auk: **segisti ja nupu jaoks 2x 35 mm auk**

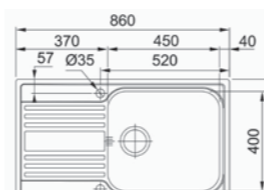

RPX 611-86XL

Nupuga avatav

Hind €

101.0498.889 **238.-**
 Roostevaba teras

Antea

Süvistatav



Valikulised lisad



112.0595.334
Puidust lõikelaud
532 x 280 mm
80.- €



ALL-IN
5 erinevat komplekti ALL IN
(rohkem lk 125) valamule:
340 x 540 mm
135.- ... 258.- €



112.0461.942
Roostevabast terasest
nõrutuskauss
297 x 187 x 72 mm
45.- €

SMART

01 02
03



Aluskapp: **60 cm**
Mõõdud: **1000 x 500 mm**
Väljalõige: **980 x 480 mm (R= 10 mm)**
Kausi mõõtmed:
340 / 420 / 155 un 170 / 280 / 80 mm
Kausi asukoht: **pööratav**
Paigaldamine: **süvistatav**
Materjal: **roostevaba teras**
Ventii: **manuaalne 3½" ventiil**
Ventii juhtimine: **põhjasõela käsitsi avamine**
Segisti auk: **ei**

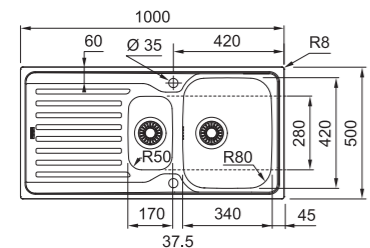

SMART

01 02



Mõõdud: **620 x 500 mm**
Väljalõige: **600 x 480 mm (R= 10 mm)**
Kausi mõõtmed: **360 / 420 / 155 mm**
Kausi asukoht: **pööratav**
Paigaldamine: **süvistatav**
Materjal: **roostevaba teras**
Ventii: **manuaalne 3½" ventiil**
Ventii juhtimine: **põhjasõela käsitsi avamine**
Segisti auk: **ei**

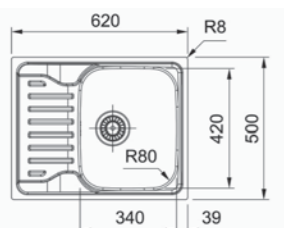

Ronda

Süvistatav



SMART



Mõõdud: **Ø 509 mm**
Väljalõige: **Ø 489 mm**
Kausi mõõtmed: **Ø 388 / 175 mm**
Materjal: **roostevaba teras**
Paigaldamine: **süvistatav**
Ventii: **manuaalne 3½" ventiil**
Ventii juhtimine: **põhjasõela käsitsi avamine**
Segisti auk: **35 mm auk**

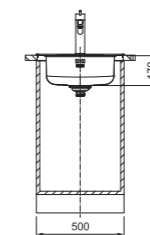
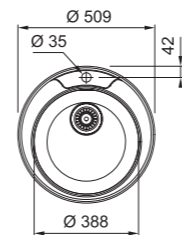

SMART



Mõõdud: **Ø 435 mm**
Väljalõige: **Ø 415 mm**
Kausi mõõtmed: **Ø 378 / 180 mm**
Materjal: **roostevaba teras**
Paigaldamine: **süvistatav**
Ventii: **manuaalne 3½" ventiil**
Ventii juhtimine: **põhjasõela käsitsi avamine**
Segisti auk: **ei**
Tööpind: **min 30 mm paksune**

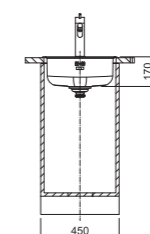
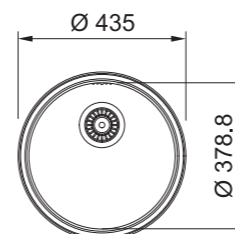

ROX 610-39

Manuaalne ventiil
101.0714.971 **86.-**
Roostevaba teras
poleeritud

RON 610-39

Manuaalne ventiil
101.0714.972 **80.-**
Roostevaba teras,
matt

ROL 610-39

Manuaalne ventiil
101.0734.373 **82.-**
Roostevaba teras
linane

ROX 610/110-38

Manuaalne ventiil
101.0725.057 **84.-**
Roostevaba teras
poleeritud



- Maris 59
- Urban 68
- Centro 72
- Basis 74
- Ronda 76



Fragraniit valamud

Fragraniit valamud

MARIS

80 cm



Maris
MRG 610-72A
63. lk.

60 cm



Urban
UBG 651-100
68. lk.



Basis
BFG 651
74. lk.



Maris
MRG 651-78
65. lk.



Basis
BFG 651-78
75. lk.



Urban
UBG 611-100
69. lk.



Maris
MRG 611-100XL
59. lk.



Maris
MRG 611-78XL
59. lk.



Urban
UBG 611-78XL
69. lk.

Nurgavalamud



MRG 612-E
60. lk.



Maris
MRG 610-54A
64. lk.



Maris
MRG 610-52A
65. lk.



Urban
UBG 610-56
71. lk.



Maris Care
MRG 610-60Care
61. lk.

50 cm



Centro
CNG 611-86
73. lk.



Urban
UBG 611-86
75. lk.

45 cm



Urban
UBG 611-78
75. lk.



Centro
CNG 611-78
73. lk.

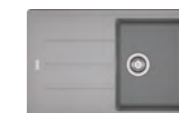

Basis
BFG 611
75. lk.



Maris
MRG 611-62
59. lk.



Urban
UBG 611-62
71. lk.



Centro
CNG 611-62
73. lk.



Basis
BFG 611-62
75. lk.



Maris
MRG 610-39A
66. lk.



Maris
MRG 610-37A
67. lk.



Ronda
ROG 611
76. lk.



Ronda
ROG 611-62
77. lk.



Ronda
ROG 610-41
77. lk.

SMART

Süvistatav



Kaasolevad lisad



01
112.0057.214
Roostevabast terasest nõrutuskauss
150 x 325 x 80 mm
33.- €

Valikulised lisad



02
112.0066.060
Roostevabast terasest nõrutuskauss
plastkäepidemetega
156 x 417 x 54 mm
116.- €



03
112.0595.334
Puidust lõikelaud
532 x 280 mm
80.- €



04
ALL-IN
5 erinevat komplekti ALL IN (rohkem lk 125) valamule:
340 x 540 mm
135.- ... 258.- €



05
112.0256.867
Rollmatt
298 x 407 mm
48.- €

Kokkusobivad tooted



115.0706.985
Glenda
Roostevaba teras
173.- €

MARIS



Mõõdud: 780 x 500 mm
Väljalõige: 760 x 480 mm (R=20mm)
Kausi mõõtmed: 350 / 425 / 200 + 160 / 300 / 120 mm
Paigaldamine: süvistatav
Kausi asukoht: pööratav
Materjal: **Fragraniit**
Ventil: nupuga avatav 3½" ventiil
Ventili juhtimine: ümar keeratav nupp sõela avamiseks või sulgemiseks
Ülevool: katteplaadiga ülevool
Komplekt sisaldab: roostevabast terasest nõrutuskauss 112.0057.214
Segisti auk: ilma aukudeta (4 x 35 mm altpoolt puuritud augud)
Tööpind: min 30 mm paksune

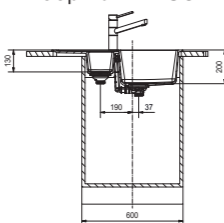
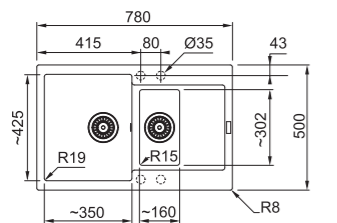

MARIS



Mõõdud: 970 x 500 mm
Väljalõige: 950 x 480 mm (R=20mm)
Kausi mõõtmed: 490 / 425 / 200 mm
Paigaldamine: süvistatav
Kausi asukoht: pööratav
Materjal: **Fragraniit**
Ventil: nupuga avatav 3½" ventiil
Ventili juhtimine: ümar keeratav nupp sõela avamiseks või sulgemiseks
Ülevool: katteplaadiga ülevool
Segisti auk: ilma aukudeta (4 x 35 mm altpoolt puuritud augud)
Tööpind: min 30 mm paksune

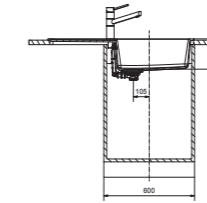
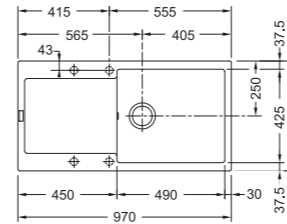

MARIS



Mõõdud: 780 x 500 mm
Väljalõige: 760 x 480 mm (R=20mm)
Kausi mõõtmed: 3490 / 425 / 200 mm
Paigaldamine: süvistatav
Kausi asukoht: pööratav
Materjal: **Fragraniit**
Ventil: nupuga avatav 3½" ventiil
Ventili juhtimine: ümar keeratav nupp sõela avamiseks või sulgemiseks
Ülevool: katteplaadiga ülevool
Segisti auk: ilma aukudeta (4 x 35 mm altpoolt puuritud augud)
Tööpind: min 30 mm paksune

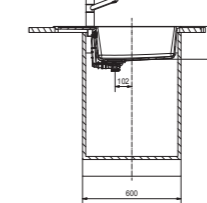
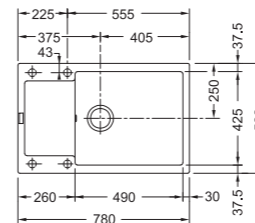

MARIS



Mõõdud: 620 x 500 mm
Väljalõige: 600 x 480 mm (R=20mm)
Kausi mõõtmed: 350 / 425 / 200 mm
Paigaldamine: süvistatav
Kausi asukoht: pööratav
Materjal: **Fragraniit**
Ventil: nupuga avatav 3½" ventiil
Ventili juhtimine: ümar keeratav nupp sõela avamiseks või sulgemiseks
Ülevool: katteplaadiga ülevool
Segisti auk: ilma aukudeta (4 x 35 mm altpoolt puuritud augud)
Tööpind: min 30 mm paksune

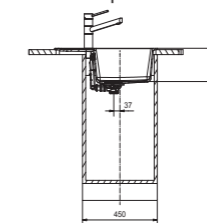
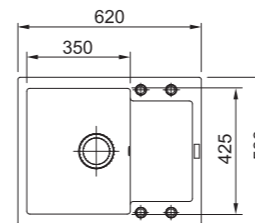

MRG 611-100XL

Nupuga avatav	Hind €
114.0627.363 Must matt	419.-
114.0378.126 Onyx	405.-
114.0378.124 Kivihall	405.-
114.0378.121 Kašmiir	405.-
114.0378.095 Polaarvalge	405.-

MRG 611-78XL

Nupuga avatav	Hind €
114.0627.365 Must matt	397.-
114.0479.032 Onyx	381.-
114.0479.030 Kivihall	381.-
114.0479.027 Kašmiir	381.-
114.0479.022 Polaarvalge	381.-

MRG 651-78

Nupuga avatav	Hind €
114.0627.289 Must matt	419.-
114.0253.333 Onyx	405.-
114.0253.335 Kivihall	405.-
114.0302.683 Kašmiir	405.-
114.0253.334 Polaarvalge	405.-

MRG 611-62

Nupuga avatav	Hind €
114.0627.370 Must matt	366.-
114.0253.322 Onyx	350.-
114.0253.324 Kivihall	350.-
114.0302.708 Kašmiir	350.-
114.0253.323 Polaarvalge	350.-

Maris



Maris Care



Süvistatav

Valikulised lisad



01

112.0066.060
Roostevabast terasest nõrutuskauss plastikäpide metega
156 x 417 x 54 mm
116.- €



02

ALL-IN
5 erinevat komplekti ALL IN (rohkem lk 125) valamule: 340 x 540 mm
135.- ... 258.- €

03



112.0688.102
Puidust lõikelaud
296 x 475 x 26 mm
80.- €

Kokkusobivad tooted



115.0706.985
Glenda
Roostevaba teras
173.- €

Valikulised lisad



01

112.0066.060
Roostevabast terasest nõrutuskauss plastikäpide metega
156 x 417 x 54 mm
116.- €



02

112.0080.355
Rullmatt painduv
468 x 440 mm
90.- €



03

ALL-IN
5 erinevat komplekti ALL IN (rohkem lk 125) valamule: 340 x 540 mm
135.- ... 258.- €



04

112.0688.102
Puidust lõikelaud
296 x 475 x 26 mm
80.- €

MARIS

01 02
03



Mõõdud: **960 x 500 mm**
Väljalõige: **Sablooni järgi**
Kausi mõõtmed: **350 / 425 / 200 mm**
Paigaldamine: **süvistatav**
Materjal: **Fragraniit**
Ventil: **nupuga avatav 3½" ventiil**
Ventili juhtimine: **ümar keeratav nupp sõela avamiseks või sulgemiseks**
Ülevool: **katteplaadiga ülevool**
Segisti auk: **ilma aukudeta (2 x 35 mm altpoolt puuritud augud)**

MRG 612-E

Nupuga avatav

Hind €

114.0197.774
Onyx

483.-

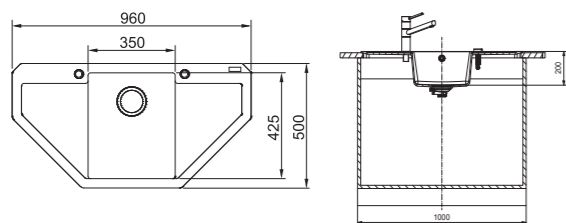

MARIS

01 02
03 04



Mõõdud: **635x559 mm**
Kausi mõõtmed: **596x422x127 mm**
Paigaldamine: **süvistatav**
Materjal: **Fragraniit**
Ventil: **manuaalne 3½" ventiil**
Ventili juhtimine: **põhjasõela käsitsi avamine**
Ülevool: **katteplaadiga ülevool**
Segisti auk: **ilma aukudeta (5 x 35 mm altpoolt puuritud augud)**
Tööpind: **min 30 mm paksune**

MRG 610-60 CARE

Manuaalne ventiil

Hind €

114.0729.484
Must matt

352.-

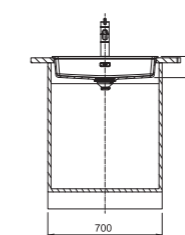
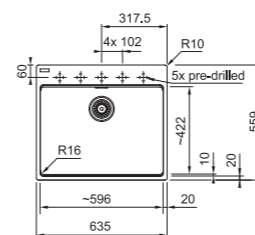

Maris

Süvistatav



Valikulised lisad

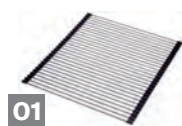

01
112.0030.882
Rullmatt paindub
468 x 420 mm
86.- €



02
112.0188.651
Rv Mobiilne nõruti
plastik raamis
342 x 430 x 22 mm
120.- €



03
112.0473.656
Augufrees 35mm
Fragraniit ja
Tektoniit
valamutele
6.- €



04
ALL-IN
5 erinevat komplekti ALL IN
(rohkem lk 125) valamule:
340 x 540 mm
135.- ... 258.- €

Kokkusobivad tooted



115.0669.768
Active L Twist
Must matt
338.- €



115.0728.396
Maris Slim Semi Pro
Must matt
350.- €

Maris

Süvistatav



MARIS

01 02
03 04



Möödud: 760 x 510 mm
Väljalõige: 740 x 498 mm (R=15 mm)
Kausi mõõtmed: 720 /400 /200 mm
Paigaldamine: süvistatav
Materjal: **Fragraniit**
Ventiil: koos ventiiliga 3½"
Ventiili juhtimine: vajutusnupp või pöördnupp
või käsitsi sõela avamine/sulgemine
Ventiil kaas: ümmargune
Ülevool: kateplaadiga ülevool
Segisti auk: ilma aukudeta (5 x 35 mm altpoolt
puuritud augud)

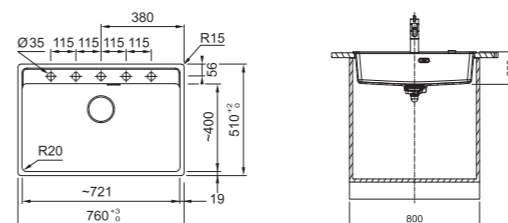

MRG 610-72A



Musta pöördnupuga
ekstsentriline klapp ja
musta ülevoolukaitsega
must ventiil

Hind €
114.0659.125 409.-
Must matt



Käsitsi 3½" ventiil musta
klapi, ülevoolude ja
klapikaanega

Hind €
114.0658.588 399.-
Must matt



Manuaalventiil
roostevabast terasest
klapikaanega

Hind €
114.0658.331 399.-
Must matt



114.0658.310 385.-
Onyx



114.0715.518 385.-
Slate Grey



114.0658.332 385.-
Kivihall



114.0658.334 385.-
Kašmiir



114.0658.333 385.-
Polaarvalge

Maris

Süvistatav



Valikulised lisad

- 01**  **112.0030.882**
Rullmatt painduv
468 x 420 mm
86.- €
- 02**  **112.0188.651**
Rv Mobiilne nõruti
plastik raamis
342 x 430 x 22 mm
120.- €
- 03**  **112.0473.656**
Augufrees 35mm
Fragraniit ja
Tektoniit
valamutele
6.- €
- 04**  **ALL-IN**
5 erinevat komplekti ALL IN
(rohkem lk 125) valamule:
340 x 540 mm
135.- ... 258.- €

Kokkusobivad tooted

-  **115.0669.768**
Active L Twist
Must matt
338.- €
-  **115.0728.396**
Maris Slim Semi Pro
Must matt
350.- €

MARIS





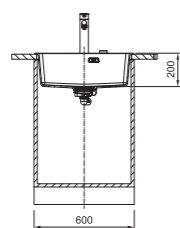
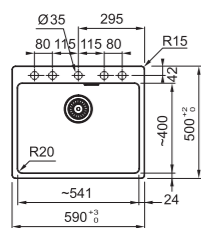

Möödud: **590 x 500 mm**
Väljalõige: **570 x 480 mm (R=15 mm)**
Kausi mõõtmed: **540 / 400 / 200 mm**
Paigaldamine: **süvistatav**
Materjal: **Fragraniit**
Ventiil: **koos ventiiliga 3½"**
Ventiili juhtimine: **ümmargune surunupp**
Ventiil kaas: **ümmargune**
Ülevool: **katteplaadiga ülevool**
Segisti auk: **ilma aukudeta (5 x 35 mm altpoolt puuritud augud)**



MRG 610-54A

 **Ekstsentriline klapp ümmarguse terasest nupu ja roostevabast terasest klapikaanega**

 **Manuaalventiil roostevabast terasest klapikaanega**

	Hind €	Hind €	Hind €
 114.0658.493 Must matt	362.-	114.0658.496 Must matt	352.-
 114.0658.494 Onyx	348.-	114.0658.497 Onyx	338.-
 114.0658.495 Kivihall	348.-	114.0658.498 Kivihall	338.-





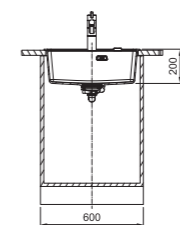
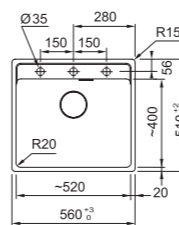





Modelis: **MRG 610-52A**
Aluskapp: **60 cm**
Möödud: **560 x 510 mm**
Väljalõige: **540 x 498 mm (R=15 mm)**
Kausi mõõtmed: **520 / 400 / 200 mm**
Paigaldamine: **süvistatav**
Materjal: **Fragraniit**
Ventiil: **koos ventiiliga 3½"**
Ventiili juhtimine: **vajutusnupp või pöördnupp või käsitsi sõela avamine/sulgmine**
Ventiil kaas: **ümmargune**
Ülevool: **katteplaadiga ülevool**
Segisti auk: **ilma aukudeta (3 x 35 mm altpoolt puuritud augud)**



MRG 610-52A

 **Musta pöördnupuga ekstsentriline klapp ja musta ülevoolukaitsega must ventiil**

 **Käsitsi 3½" ventiil musta klapi, ülevoolude ja klapikaanega**

	Hind €	Hind €	Hind €
 114.0659.124 Must matt	358.-	114.0658.586 Must matt	352.-
 114.0658.294 Must matt	362.-	114.0658.299 Must matt	352.-
 114.0658.293 Onyx	348.-	114.0658.298 Onyx	336.-
 114.0715.519 Slate Grey	348.-	114.0715.520 Slate Grey	336.-
 114.0658.295 Kivihall	348.-	114.0658.300 Kivihall	336.-
 114.0658.297 Kašmiir	348.-	114.0658.302 Kašmiir	336.-
 114.0658.296 Polaarvalge	348.-	114.0658.301 Polaarvalge	336.-

Maris

Süvistatav



Valikulised lisad

- 01**  **112.0030.882**
Rullmatt painduv
468 x 420 mm
86.- €
- 02**  **112.0188.651**
Rv Mobiilne nõruti
plastik raamis
342 x 430 x 22 mm
120.- €
- 03**  **112.0473.656**
Augufrees 35mm
Fragraniit ja
Tektoniit
valamutele
6.- €
- 04**  **ALL-IN**
5 erinevat komplekti ALL IN
(rohkem lk 125) valamute:
340 x 540 mm
135.- ... 258.- €

Kokkusobivad tooted

-  **115.0669.768**
Active L Twist
Must matt
338.- €
-  **115.0728.396**
Maris Slim Semi Pro
Must matt
350.- €

MARIS

01 02
03 04



Möödud: **440 x 500 mm**
Väljalõige: **420 x 480 mm (R=15 mm)**
Kausi mõõtmed: **390 / 400 / 200 mm**
Paigaldamine: **süvistatav**
Materjal: **Fragraniit**
Ventiil: **koos ventiiliga 3½"**
Ventiili juhtimine: **ümmargune vajutusnupp**
Ventiil kaas: **ümmargune**
Ülevool: **katteplaadiga ülevool**
Segisti auk: **ilma aukudeta (3 x 35 mm altpoolt puuritud augud)**

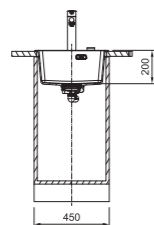
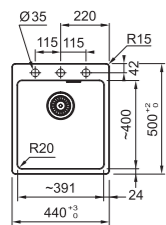

Maris

Süvistatav

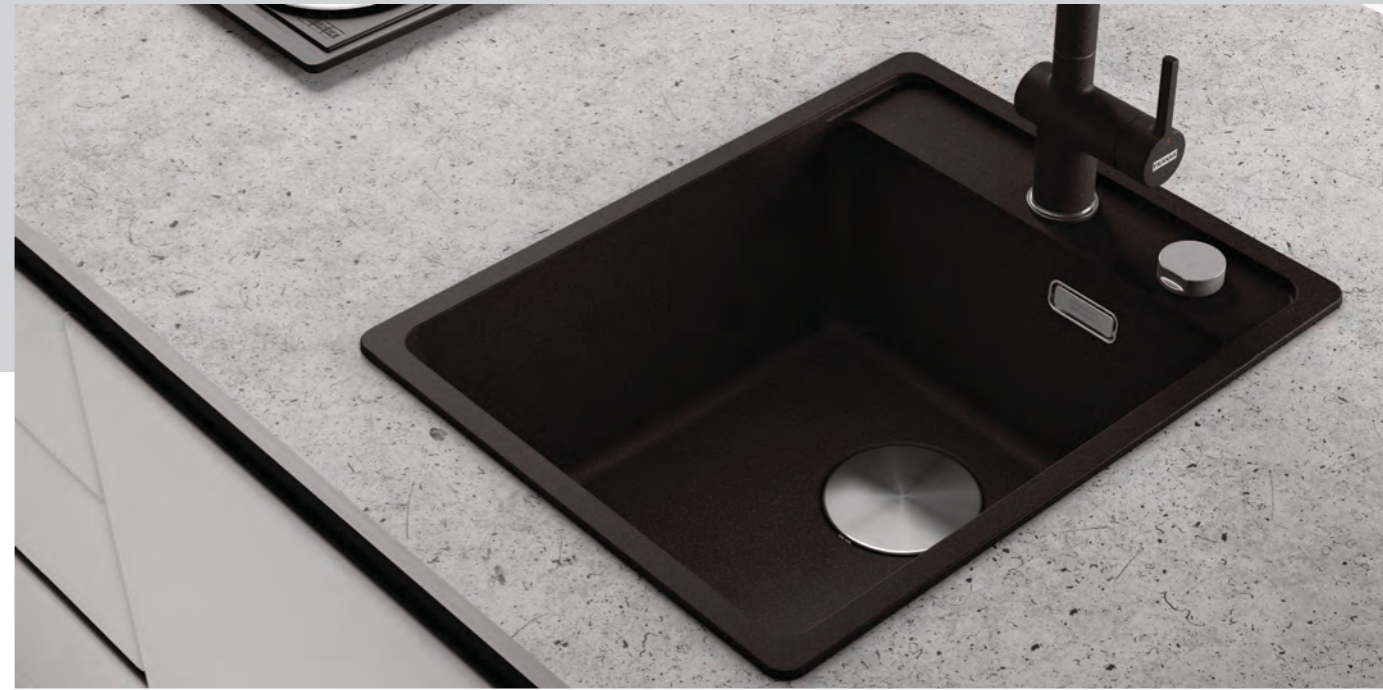

MARIS

01 02
03 04



Möödud: **410 x 510 mm**
Väljalõige: **390 x 498 mm (R=15 mm)**
Kausi mõõtmed: **370 / 400 / 200 mm**
Paigaldamine: **süvistatav**
Materjal: **Fragraniit**
Ventiil: **koos ventiiliga 3½"**
Ventiili juhtimine: **vajutusnupp või pöördnupp või käsitsi sõela avamine/sulgmine**
Ventiil kaas: **ümmargune**
Ülevool: **katteplaadiga ülevool**
Segisti auk: **ilma aukudeta (3 x 35 mm altpoolt puuritud augud)**

MRG 610-37A

 **Musta pöördnupuga ekstsentriline klapp ja musta ülevoolukaitsega must ventiil**

114.0659.123
Must matt

Hind €

306.-

 **Käsitsi 3½" ventiili musta klapi, ülevoolude ja klapikaanega**



114.0658.583
Must matt

Hind €

300.-

MRG 610-39 A

 **Ekstsentriline klapp ümmarguse terasest nupu ja roostevabast terasest klapikaanega**

-  **114.0658.417** **314.-**
Must matt
-  **114.0658.418** **300.-**
Onyx
-  **114.0658.419** **300.-**
Kivihall

Hind €

314.-

300.-

300.-

 **Ekstsentriline klapp ümmarguse terasest nupu ja roostevabast terasest klapikaanega**

114.0658.254 **312.-**
Must matt

Hind €

312.-

 **Manuaalventiil roostevabast terasest klapikaanega**

114.0658.217 **300.-**
Must matt

Hind €

300.-

114.0658.140 **298.-**
Onyx

Hind €

298.-

114.0658.216 **288.-**
Onyx

Hind €

288.-

114.0715.521 **298.-**
Slate Grey

Hind €

298.-

114.0715.522 **288.-**
Slate Grey

Hind €

288.-

114.0658.255 **298.-**
Kivihall

Hind €

298.-

114.0658.218 **288.-**
Kivihall

Hind €

288.-

114.0658.257 **298.-**
Kašmiir

Hind €

298.-

114.0658.220 **288.-**
Kašmiir

Hind €

288.-

114.0658.256 **298.-**
Polaarvalge

Hind €

298.-

114.0658.219 **288.-**
Polaarvalge

Hind €

288.-

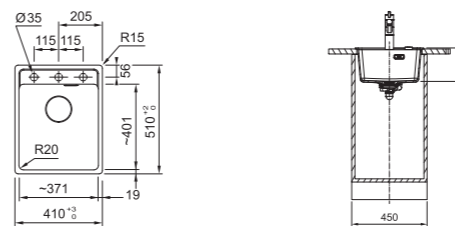

Süvistatav



Kaasolevad lisad



01
112.0566.182
Plastikust kandik
320 x 174 x 90 mm

Valikulised lisad



02
112.0066.060
Roostevabast terasest nõrutuskauss plastkäepidemetega
156 x 417 x 54 mm
116.- €



03
112.0595.334
Puidust lõikelaud
532 x 280 mm
80.- €



04
112.0473.656
Augufrees 35mm
Fragraniit ja Tektoniit valamutele
6.- €



05
ALL-IN
5 erinevat komplekti ALL IN (rohkem lk 125) valamule:
340 x 540 mm
135.- ... 258.- €

Kokkusobivad tooted



115.0669.768
Active L Twist
Must matt
338.- €

MARIS



Mõõdud: **1000 x 500 mm**
Väljalõige: **980 x 480 mm (R=15mm)**
Kausi mõõtmed: **350/425 /220 + 166/ 322 / 80 mm**
Paigaldamine: **süvistatav**
Kausi asukoht: **pööratav**
Materjal: **Fragraniit**
Ventii: **nupuga avatav 3½" ventiil**
Ventii juhtimine: **ümar keeratav nupp sõela avamiseks või sulgemiseks**
Ülevool: **katteplaadiga ülevool**
Segisti auk: **ilma aukudeta (2 x 35 mm altpool puuritud augud)**
Täiustatud töölaauaversioon: **min 30 mm paksune**
Tööpind tasapinnaline: **min 38 mm paksune**

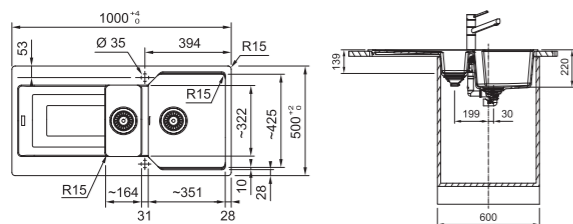

UBG 651-100

Ekstsentriline nupp	Hind €
114.0682.734	381.-
114.0682.534	368.-
114.0723.971	368.-
114.0682.533	368.-
114.0682.532	368.-
114.0682.526	368.-

MARIS



Mõõdud: **1000 x 500 mm**
Väljalõige: **980 x 480 mm (R=15mm)**
Kausi mõõtmed: **490/425 /220 mm**
Paigaldamine: **tasapinnaline või süvistatav**
Kausi asukoht: **pööratav**
Materjal: **Fragraniit**
Ventii: **nupuga avatav 3½" ventiil**
Ventii juhtimine: **ümar keeratav nupp sõela avamiseks või sulgemiseks**
Ülevool: **katteplaadiga ülevool**
Segisti auk: **ilma aukudeta (2 x 35 mm altpool puuritud augud)**
Täiustatud töölaauaversioon: **min 30 mm paksune**
Tööpind tasapinnaline: **min 38 mm paksune**

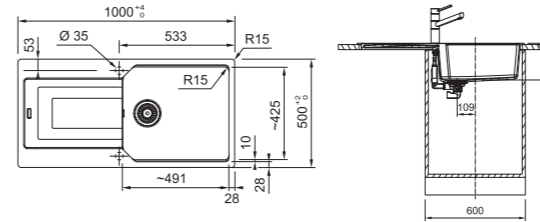

UBG 611-100

Ekstsentriline nupp	Hind €
114.0682.733	399.-
114.0682.530	385.-
114.0724.276	385.-
114.0682.529	385.-
114.0682.528	385.-
114.0682.525	385.-

MARIS



Mõõdud: **780 x 500 mm**
Väljalõige: **760 x 480 mm (R=15mm)**
Kausi mõõtmed: **490/425 /220 mm**
Paigaldamine: **süvistatav**
Kausi asukoht: **pööratav**
Materjal: **Fragraniit**
Ventii: **nupuga avatav 3½" ventiil**
Ventii juhtimine: **ümar keeratav nupp sõela avamiseks või sulgemiseks**
Ülevool: **katteplaadiga ülevool**
Segisti auk: **ilma aukudeta (2 x 35 mm altpool puuritud augud)**
Täiustatud töölaauaversioon: **min 30 mm paksune**
Tööpind tasapinnaline: **min 38 mm paksune**

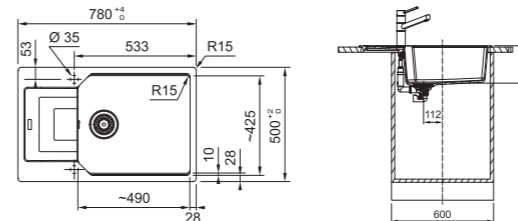

UBG 611-78XL

Ekstsentriline klapp ümmarguse terasest nupu ja roostevabast terasest klapikaanega	Hind €
114.0682.737	346.-
114.0682.570	330.-
114.0723.970	330.-
114.0682.569	330.-
114.0682.567	330.-
114.0682.565	330.-

Süvistatav



Valikulised lisad



01

112.0066.060
Roostevabast terasest nõrutuskauss plastkäepidemetega
156 x 417 x 54 mm
116.- €



02

112.0595.334
Puidust lõikelaud
532 x 280 mm
80.- €



03

112.0473.656
Augufrees 35mm
Fragraniit ja Tektoniit valamutele
6.- €



04

ALL-IN
5 erinevat komplekti ALL IN (rohkem lk 125) valamule:
340 x 540 mm
135.- ... 258.- €

Kokkusobivad tooted



115.0669.768
Active L Twist
Must matt
338.- €

MARIS
01 02
03 04



Möödud: **620 x 500 mm**
Väljalõige: **600 x 480 mm (R=15mm)**
Kausi mõõtmed: **350/425 /220 mm**
Paigaldamine: **süvistatav**
Kausi asukoht: **pööratav**
Materjal: **Fragraniit**
Ventiil: **nupuga avatav 3½" ventiil**
Ventiili juhtimine: **ümar keeratav nupp sõela avamiseks või sulgemiseks**
Ülevool: **katteplaadiga ülevool**
Segisti auk: **ilma aukudeta (2 x 35 mm altpoolt puuritud augud)**
Täiustatud töölauaversioon: **min 30 mm paksune**
Tööpind tasapinnaline: **min 38 mm paksune**

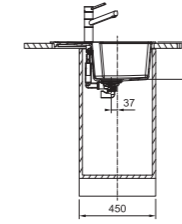
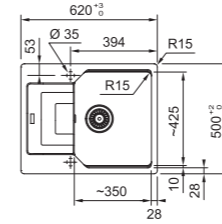

MARIS
01 02
03 04



Möödud: **560 x 500 mm**
Väljalõige: **540 x 480 mm (R=15mm)**
Kausi mõõtmed: **503/425 /220 mm**
Paigaldamine: **süvistatav**
Materjal: **Fragraniit**
Ventiil: **nupuga avatav 3½" ventiil**
Ventiili juhtimine: **ümar keeratav nupp sõela avamiseks või sulgemiseks**
Ülevool: **katteplaadiga ülevool**
Segisti auk: **ilma aukudeta (2 x 35 mm altpoolt puuritud augud)**
Täiustatud töölauaversioon: **min 30 mm paksune**
Tööpind tasapinnaline: **min 38 mm paksune**

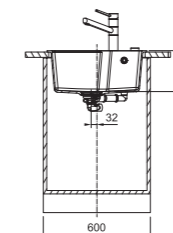
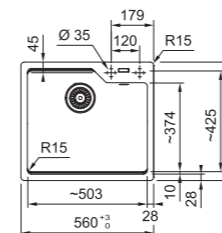

UBG 611-62

114.0682.735
Musta pöördnupuga ekstsentriline klapp ja musta ülevoolukaitsega must ventiil
Must matt
Hind €
316.-

114.0682.549
Ekstsentriline klapp ümmarguse terasest nupu ja roostevabast terasest klapikaanega
Onyx
Hind €
302.-

114.0723.968
Slate Grey
302.-

114.0682.548
Kivihall
302.-

114.0682.547
Kašmiir
302.-

114.0682.545
Polaarvalge
302.-

UBG 610-56

114.0682.738
Musta pöördnupuga ekstsentriline klapp ja musta ülevoolukaitsega must ventiil
Must matt
Hind €
350.-

114.0682.644
Ekstsentriline klapp ümmarguse terasest nupu ja roostevabast terasest klapikaanega
Onyx
Hind €
336.-

114.0723.966
Slate Grey
336.-

114.0682.643
Kivihall
336.-

114.0682.642
Kašmiir
336.-

114.0682.600
Polaarvalge
336.-

Süvistatav



Valikulised lisad



01

112.0595.334
Puidust lõikelaud
532 x 280 mm
80.- €



02

112.0473.656
Augufrees 35mm
Fragraniit ja
Tektoniit
valamutele
6.- €



03

ALL-IN
5 erinevat komplekti ALL IN
(rohkem lk 125) valamule:
340 x 540 mm
135.- ... 258.- €



04

112.0741.539
Must ülevoolukate
36.- €

Kokkusobivad tooted



115.0669.768
Active L Twist
Must matt
338.- €

MARIS

01 02
03 04



Mõõdud: **860 x 500 mm**
Väljalõige: **840 x 480 mm (R=15mm)**
Kausi mõõtmed: **392/435 /220 mm**
Paigaldamine: **tasapinnaline või süvistatav**
Kausi asukoht: **pööratav**
Materjal: **Fragraniit**
Ventil: **nupuga avatav 3½" ventiil**
Ventili juhtimine: **ümar keeratav nupp sõela avamiseks või sulgemiseks**
Ülevool: **katteplaadiga ülevool**
Segisti auk: **ilma aukudeta (2 x 35 mm altpoolt puuritud augud)**
Täiustatud töölaauaversioon: **min 30 mm paksune**
Tööpind tasapinnaline: **min 38 mm paksune**

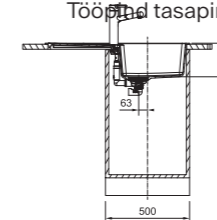
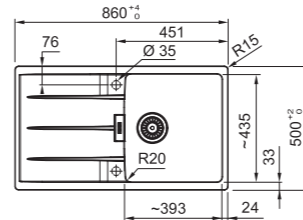

MARIS

01 02
03 04

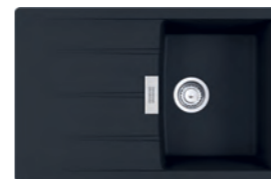

Mõõdud: **780 x 500 mm**
Väljalõige: **760 x 480 mm (R=15mm)**
Kausi mõõtmed: **342 /435 /200 mm**
Paigaldamine: **tasapinnaline või süvistatav**
Materjal: **Fragraniit**
Ventil: **nupuga avatav 3½" ventiil**
Ventili juhtimine: **ümar keeratav nupp sõela avamiseks või sulgemiseks**
Ülevool: **katteplaadiga ülevool**
Segisti auk: **ilma aukudeta (2 x 35 mm altpoolt puuritud augud)**
Täiustatud töölaauaversioon: **min 30 mm paksune**
Tööpind tasapinnaline: **min 38 mm paksune**

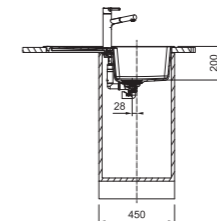
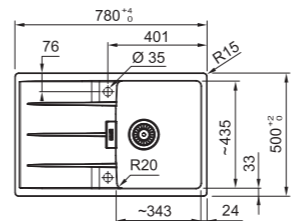

MARIS

01 02
03 04



Mõõdud: **620 x 500 mm**
Väljalõige: **600 x 480 mm (R=15mm)**
Kausi mõõtmed: **342 /435 /200 mm**
Paigaldamine: **tasapinnaline või süvistatav**
Materjal: **Fragraniit**
Ventil: **nupuga avatav 3½" ventiil**
Ventili juhtimine: **ümar keeratav nupp sõela avamiseks või sulgemiseks**
Ülevool: **katteplaadiga ülevool**
Segisti auk: **ilma aukudeta (2 x 35 mm altpoolt puuritud augud)**
Täiustatud töölaauaversioon: **min 30 mm paksune**
Tööpind tasapinnaline: **min 38 mm paksune**

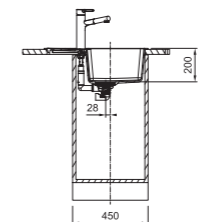
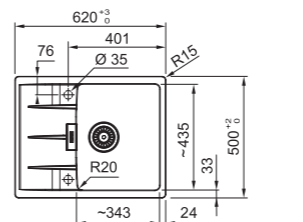

CNG 611-86

Ekstsentriline nupp	Hind €
114.0682.460 Must matt	403.-
114.0682.458 Onyx	387.-
114.0715.513 Slate Grey	387.-
114.0682.459 Kivihall	387.-
114.0682.502 Kašmiir	387.-
114.0682.501 Polaarvalge	387.-

CNG 611-78

Ekstsentriline nupp	Hind €
114.0681.584 Must matt	373.-
114.0681.581 Onyx	360.-
114.0715.514 Slate Grey	360.-
114.0681.583 Kivihall	360.-
114.0681.586 Kašmiir	360.-
114.0681.585 Polaarvalge	360.-

CNG 611-62

Ekstsentriline nupp	Hind €
114.0681.428 Must matt	344.-
114.0681.426 Onyx	330.-
114.0715.515 Slate Grey	330.-
114.0681.427 Kivihall	330.-
114.0681.430 Kašmiir	330.-
114.0681.429 Polaarvalge	330.-



Valikulised lisad

- 01**  **112.0595.334**
Puidust lõikelaud
532 x 280 mm
80.- €
- 02**  **112.0473.656**
Augufrees 35mm
Fragraniit ja
Tektoniit
valamutele
6.- €
- 03**  **ALL-IN**
5 erinevat komplekti ALL IN
(rohkem lk 125) valamule:
340 x 540 mm
135.- ... 258.- €

Kokkusobivad tooted

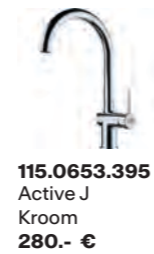

MARIS





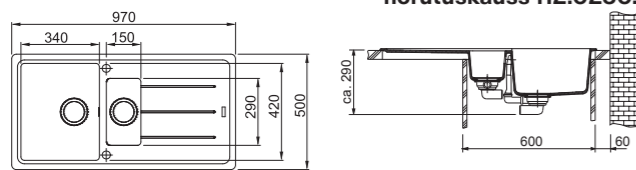

01 02
03



Mõõdud: **970 x 500 mm**
Väljalõige: **950 x 480 mm (R=12mm)**
Kausi mõõtmed: **340 / 420 / 200 + 150 / 290 / 90 mm**
Paigaldamine: **süvistatav**
Kausi asukoht: **pööratav**
Materjal: **Fragraniit**
Ventil: **nupuga avatav 3½" ventiil**
Ventili juhtimine: **ümar keeratav nupp sõela avamiseks või sulgemiseks**
Ülevool: **katteplaadiga ülevool**
Segisti auk: **ilma aukudeta (4 x 35 mm altpoolt puuritud augud)**
Tööpind: **min 30 mm paksune**
Komplekt sisaldab: **Roostevabast terasest nõrutuskauss 112.0250.014**



BFG 651

Ekstsentriline nupp	Hind €
 114.0657.807 Must matt	395.-
 114.0256.625 Onyx	381.-
 114.0723.973 Slate Grey	381.-
 114.0256.627 Kivihall	381.-
 114.0301.961 Kašmiir	381.-
 114.0256.624 Beež	381.-
 114.0256.626 Polaarvalge	381.-

MARIS





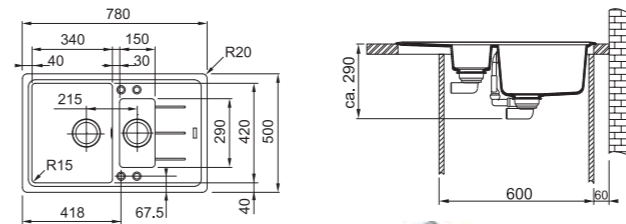

01 02
03



Mõõdud: **780 x 500 mm**
Väljalõige: **760 x 480 mm (R=12mm)**
Kausi mõõtmed: **340 / 420 / 200 + 150 / 290 / 90 mm**
Paigaldamine: **süvistatav**
Kausi asukoht: **pööratav**
Materjal: **Fragraniit**
Ventil: **nupuga avatav 3½" ventiil**
Ventili juhtimine: **ümar keeratav nupp sõela avamiseks või sulgemiseks**
Ülevool: **katteplaadiga ülevool**
Segisti auk: **ilma aukudeta (4 x 35 mm altpoolt puuritud augud)**
Tööpind: **min 30 mm paksune**
Komplekt sisaldab: **Roostevabast terasest nõrutuskauss 112.0250.014**



BFG 651-78

Ekstsentriline nupp	Hind €
 114.0657.808 Must matt	360.-
 114.0301.345 Onyx	346.-
 114.0723.961 Slate Grey	346.-
 114.0301.367 Kivihall	346.-
 114.0301.951 Kašmiir	346.-
 114.0301.370 Beež	346.-
 114.0301.368 Polaarvalge	346.-

MARIS



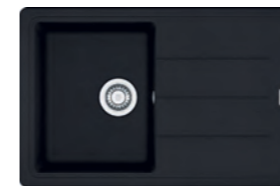

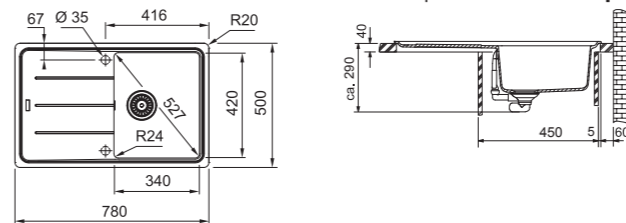

01 02
03



Mõõdud: **780 x 500 mm**
Väljalõige: **760 x 480 mm (R=12mm)**
Kausi mõõtmed: **340 / 420 / 200 mm**
Paigaldamine: **süvistatav**
Kausi asukoht: **pööratav**
Materjal: **Fragraniit**
Ventil: **nupuga avatav 3½" ventiil**
Ventili juhtimine: **ümar keeratav nupp sõela avamiseks või sulgemiseks**
Ülevool: **katteplaadiga ülevool**
Segisti auk: **ilma aukudeta (2 x 35 mm altpoolt puuritud augud)**
Tööpind: **min 30 mm paksune**



BFG 611

Ekstsentriline nupp	Hind €
 114.0657.822 Must matt	308.-
 114.0256.610 Onyx	294.-
 114.0723.958 Slate Grey	294.-
 114.0256.612 Kivihall	294.-
 114.0301.907 Kašmiir	294.-
 114.0256.609 Beež	294.-
 114.0256.611 Polaarvalge	294.-

MARIS





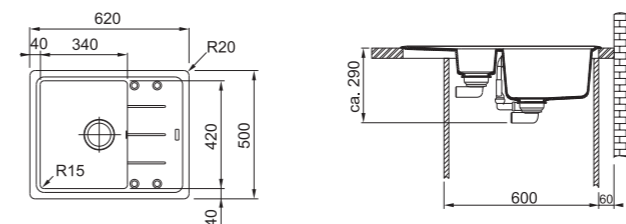

01 02
03



Mõõdud: **620 x 500 mm**
Väljalõige: **600 x 480 mm (R=12mm)**
Kausi mõõtmed: **340 / 420 / 200 mm**
Paigaldamine: **süvistatav**
Kausi asukoht: **pööratav**
Materjal: **Fragraniit**
Ventil: **nupuga avatav 3½" ventiil**
Ventili juhtimine: **ümar keeratav nupp sõela avamiseks või sulgemiseks**
Ülevool: **katteplaadiga ülevool**
Segisti auk: **ilma aukudeta (4 x 35 mm altpoolt puuritud augud)**
Tööpind: **min 30 mm paksune**



BFG 611-62

Ekstsentriline nupp	Hind €
 114.0657.810 Must matt	294.-
 114.0301.331 Onyx	280.-
 114.0723.957 Slate Grey	280.-
 114.0301.333 Kivihall	280.-
 114.0301.903 Kašmiir	280.-
 114.0301.342 Beež	280.-
 114.0301.335 Polaarvalge	280.-

Ronda

Süvistatav



SMART



Mõõdud: 770 x 500 mm
 Väljalõige: Šablooni järgi
 Kausi mõõtmed: Ø 410 /195 mm
 Paigaldamine: süvistatav
 Kausi asukoht: pööratav
 Materjal: **Fragraniit**
 Ventii: **nupuga või manuaalne 3½" ventiil**
 Ventii juhtimine: **ümar keeratav nupp sõela avamiseks või sulgemiseks või põhjasõela käsitsi avamine**
 Segisti auk: ilma aukudeta (2 x 35 mm altpoolt puuritud augud)
 Tööpind: min 30 mm paksune

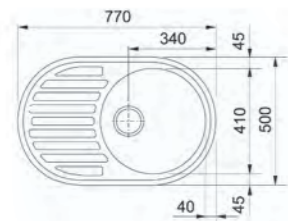

ROG 611

	Ekstsentriline nupp	Hind €
	114.0031.171 Beež	258.-
	Manuaalne ventiil	Hind €
	114.0700.629 Must matt	252.-
	114.0029.528 Beež	239.-

SMART



Mõõdud: 620 x 500 mm
 Väljalõige: Šablooni järgi
 Kausi mõõtmed: Ø 410 /195 mm
 Paigaldamine: süvistatav
 Kausi asukoht: pööratav
 Materjal: **Fragraniit**
 Ventii: **manuaalne 3½" ventiil**
 Ventii juhtimine: **põhjasõela käsitsi avamine**
 Ülevool: **katteplaadiga ülevool**
 Segisti auk: ilma aukudeta (2 x 35 mm altpoolt puuritud augud)
 Tööpind: min 30 mm paksune

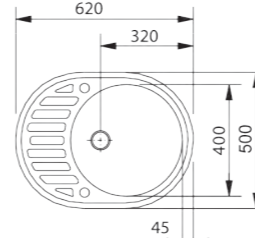

SMART



Mõõdud: Ø 510 mm
 Väljalõige: Ø 493 mm
 Kausi mõõtmed: Ø 400 /195 mm
 Paigaldamine: süvistatav
 Materjal: **Fragraniit**
 Ventii: **nupuga või manuaalne 3½" ventiil**
 Ventii juhtimine: **ümar keeratav nupp sõela avamiseks või sulgemiseks või põhjasõela käsitsi avamine**
 Segisti auk: 35 mm auk + augu jaoks eelnevalt puuritud koht
 Tööpind: min 30 mm paksune

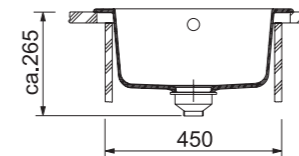
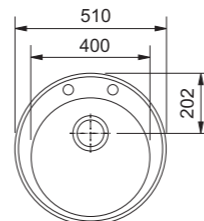

ROG 611-62

	Manuaalne ventiil	Hind €
	114.0316.526 Onyx	233.-
	114.0316.528 Beež	233.-

ROG 610-41

	Ekstsentriline nupp	Hind €
	114.0199.717 Onyx	225.-
	114.0723.992 Slate Grey	225.-
	114.0009.505 Kivihall	225.-
	114.0009.506 Beež	225.-
	114.0009.509 Polarvalge	225.-

	Manuaalne ventiil	Hind €
	114.0700.628 Must matt	219.-
	114.0199.718 Onyx	205.-
	114.0723.965 Slate Grey	205.-
	114.0009.542 Kivihall	205.-
	114.0009.543 Beež	205.-
	114.0009.546 Polarvalge	205.-

Tektoniit valamud



Sirius 82

Single 85



Tektoniit valamud



SMART

60 cm



Sirius
S2D 651
82. lk.



Sirius
S2D 611-100
83. lk.

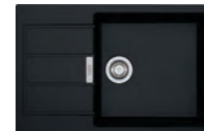

Sirius
S2D 611-78XL
83. lk.



Sirius
SID 610
84. lk.

50 cm



Sirius
S2D 611-78
83. lk.

40 cm



Sirius
S2D 611-62
84. lk.



Sirius
SID 610-40
84. lk.



SINGLE
85. lk.

Sirius Tektoniit



Valikulised lisad

- 01

112.0512.280
Hall plastikust
perforeeritud
põhjaga kandik
456 x 179 x 92 mm
24.- €
- 02

112.0595.334
Puidust lõikelaud
532 x 280 mm
80.- €
- 03

ALL-IN
5 erinevat komplekti ALL IN
(rohkem lk 125) valamule:
340 x 540 mm
135.- ... 258.- €

Kokkusobivad tooted

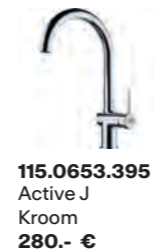

115.0653.395
Active J
Kroom
280.- €

SMART

01 02
03



Mõõdud: **1000 x 500 mm**
Väljalõige: **984 x 484 mm (R = 7,5 mm)**
Kausi mõõtmed: **350 / 432 / 200 + 150 / 350 / 150 mm**
Paigaldamine: **süvistatav**
Kausi asukoht: **pööratav**
Materjal: **Tektoniit**
Ventiil: **manuaalne 3½" ventiil**
Ventiili juhtimine: **põhjasõela käsitsi avamine**
Ülevool: **katteplaadiga ülevool**
Segisti auk: **erinev**
Tööpind: **min 30 mm paksune**

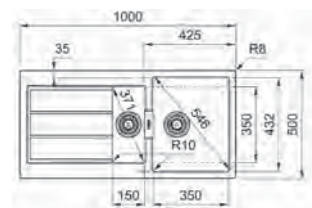

S2D 651

	Manuaalne ventiil	Hind €
	143.0615.629 Carbon must	223.-
	143.0615.785 Urban hall	223.-
	143.0615.781 Arktiline valge	223.-

SMART

01 02
03



Mõõdud: **1000 x 500 mm**
Väljalõige: **984 x 484 mm (R = 7,5 mm)**
Kausi mõõtmed: **450 / 432 / 200 mm**
Paigaldamine: **süvistatav**
Kausi asukoht: **pööratav**
Materjal: **Tektoniit**
Ventiil: **manuaalne 3½" ventiil**
Ventiili juhtimine: **põhjasõela käsitsi avamine**
Ülevool: **katteplaadiga ülevool**
Segisti auk: **ei**
Tööpind: **min 30 mm paksune**

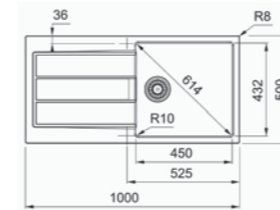

SMART

01 02
03



Mõõdud: **780 x 500 mm**
Väljalõige: **764 x 484 mm (R = 7,5 mm)**
Kausi mõõtmed: **350 / 432 / 200 mm**
Paigaldamine: **süvistatav**
Kausi asukoht: **pööratav**
Materjal: **Tektoniit**
Ventiil: **manuaalne 3½" ventiil**
Ventiili juhtimine: **põhjasõela käsitsi avamine**
Ülevool: **katteplaadiga ülevool**
Segisti auk: **ei**
Tööpind: **min 30 mm paksune**

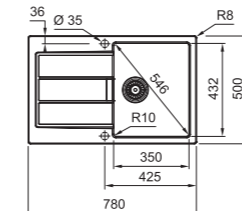

SMART

01 02
03



Mõõdud: **780 x 500 mm**
Väljalõige: **764 x 484 mm (R = 7,5 mm)**
Kausi mõõtmed: **440 / 432 / 200 mm**
Paigaldamine: **süvistatav**
Kausi asukoht: **pööratav**
Materjal: **Tektoniit**
Ventiil: **manuaalne 3½" ventiil**
Ventiili juhtimine: **põhjasõela käsitsi avamine**
Ülevool: **katteplaadiga ülevool**
Segisti auk: **ei**
Tööpind: **min 30 mm paksune**

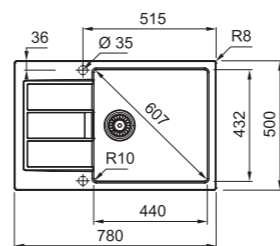

S2D 611-100

	Manuaalne ventiil	Hind €
	143.0590.212 Carbon must	188.-
	143.0590.207 Urban hall	188.-
	143.0670.831 Beež	188.-
	143.0590.205 Arktiline valge	188.-

S2D 611-78

	Manuaalne ventiil	Hind €
	143.0590.196 Carbon must	173.-
	143.0590.191 Urban hall	173.-
	143.0590.159 Arktiline valge	173.-

S2D 611-78XL

	Manuaalne ventiil	Hind €
	143.0590.228 Carbon must	173.-
	143.0590.223 Urban hall	173.-
	143.0670.832 Beež	173.-
	143.0590.221 Arktiline valge	173.-

SMART

01 02
03

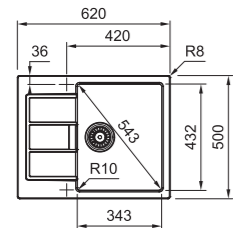

Mõõdud: **620 x 500 mm**
Väljalõige: **604 x 484 mm (R = 7,5 mm)**
Kausi mõõtmed: **343 /432 /200 mm**
Paigaldamine: **süvistatav**
Kausi asukoht: **pööratav**
Materjal: **Tektoniit**
Ventii: **manuaalne 3½" ventii**
Ventii juhtimine: **põhjasõela käsitsi avamine**
Ülevool: **katteplaadiga ülevool**
Segisti auk: **ei**
Tööpind: **min 30 mm paksune**

S2D 611-62

Manuaalne ventii	Hind €
143.0616.339 Carbon must	164.-
143.0616.345 Urban hall	164.-
143.0670.833 Beež	164.-
143.0616.341 Arktiline valge	164.-



SMART

03

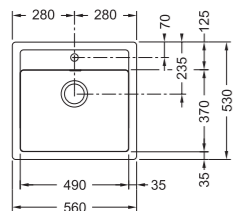

Mõõdud: **560 x 530 mm**
Väljalõige: **540 x 510 mm**
Kausi mõõtmed: **490 /370 /200 mm**
Paigaldamine: **süvistatav**
Materjal: **Tektoniit**
Ventii: **manuaalne 3½" ventii**
Ventii juhtimine: **põhjasõela käsitsi avamine**
Ülevool: **katteplaadiga ülevool**
Segisti auk: **35 mm auk**
Tööpind: **min 30 mm paksune**

SID 610

Manuaalne ventii	Hind €
114.0368.467 Carbon must	173.-
114.0463.958 Urban hall	173.-
143.0675.481 Beež	173.-
114.0368.449 Arktiline valge	173.-

SMART

03

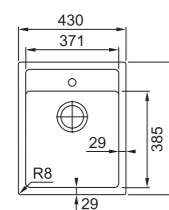

Mõõdud: **430 x 530 mm**
Väljalõige: **410 x 510 mm**
Kausi mõõtmed: **371 /385 /200 mm**
Paigaldamine: **süvistatav**
Materjal: **Tektoniit**
Ventii: **manuaalne 3½" ventii**
Ventii juhtimine: **põhjasõela käsitsi avamine**
Ülevool: **katteplaadiga ülevool**
Segisti auk: **35 mm auk**
Tööpind: **min 30 mm paksune**

SID 610-40

Manuaalne ventii	Hind €
114.0500.019 Carbon must	161.-
114.0500.012 Urban hall	161.-
143.0675.501 Beež	161.-
114.0499.970 Arktiline valge	161.-

Valikulised lisad

112.0512.280 Hall plastikust perforeeritud põhjaga kandik 456 x 179 x 92 mm 24.- €	112.0595.334 Puidust lõikelaud 532 x 280 mm 80.- €	ALL-IN 5 erinevat komplekti ALL IN (rohkem lk 125) valamule: 340 x 540 mm 135.- ... 258.- €
---	---	---

Kokkusobivad tooted



115.0653.395
Active J
Kroom
280.- €

SMART

03

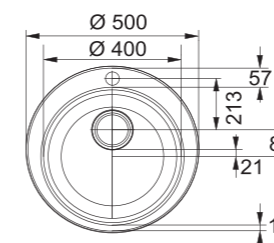

Mõõdud: **Ø 500 mm**
Väljalõige: **Ø 480 mm**
Kausi mõõtmed: **Ø 400 /150 mm**
Paigaldamine: **süvistatav**
Materjal: **Tektoniit**
Ventii: **manuaalne 3½" ventii**
Ventii juhtimine: **põhjasõela käsitsi avamine**
Tööpind: **min 30 mm paksune**

SINGLE 1

Manuaalne ventii	Hind €
114.0463.694 Carbon must	123.-
114.0463.698 Urban hall	123.-
114.0463.691 Arktiline valge	123.-

Keraamilised valamud



Mythos 89

Belfast 89



Mythos

Süvistatav



MYTHOS



Mõõdud: **590 x 510 mm**
 Kausi mõõtmed: **520 / 380 / 190 mm**
 Paigaldamine: **süvistatav**
 Materjal: **Fraceram**
 Ventii: **nupuga avatav 3½" ventiil**
 Ventii juhtimine: **ümmargune vajutusnupp**
 Ülevool: **katteplaadiga ülevool**
 Segisti auk: **2 auku ja 1 x 35 mm altpool ettevalmistatud auk**

NEW

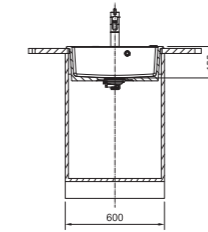
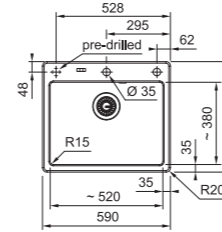

MYTHOS

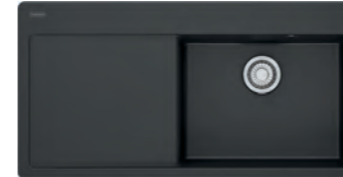

Mõõdud: **1000 x 510 mm**
 Kausi mõõtmed: **520 / 380 / 190 mm**
 Paigaldamine: **süvistatav**
 Materjal: **Fraceram**
 Ventii: **nupuga avatav 3½" ventiil**
 Ventii juhtimine: **ümmargune vajutusnupp**
 Ülevool: **katteplaadiga ülevool**
 Segisti auk: **2 auku ja 1 x 35 mm altpool ettevalmistatud auk**



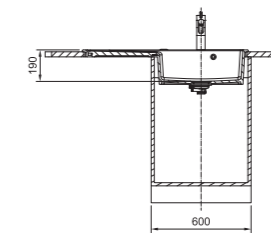
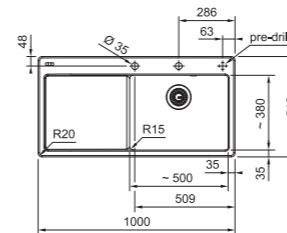

NEW



Saadaval alates juunist 2026.



MYK 610-52 A

ümmargune vajutusnupp



	Hind €
 124.0747.108 Antratsiit matt	602.-
 124.0747.109 Onyx läikiv	602.-
 124.0747.111 Polaarvalge läikiv	602.-
 124.0747.110 Magnolia läikiv	602.-

MYK 611-100

Suur kaus paremal ümmargune vajutusnupp

	Hind €
 124.0747.079 Antratsiit matt	915.-
 124.0747.101 Onyx läikiv	915.-
 124.0747.103 Polaarvalge läikiv	915.-

Suur kaus vasakul ümmargune vajutusnupp

	Hind €
 124.0747.104 Antratsiit matt	915.-
 124.0747.105 Onyx läikiv	915.-
 124.0747.107 Polaarvalge läikiv	915.-

Valikulised lisad



01	112.0030.882 Rullmatt paindub 468 x 420 mm 86.- €
02	112.0188.653 Rv Mobiilne nõruti plastik raamis 333x417x22mm 80.- €
03 NEW	112.0747.151 Roostevabast terasest nõrutuskauss plastikäepidemetega 395x157x54mm 33.- €
04 NEW	112.0747.094 Puidust lõikelaud 410x240x26 mm 70.- €

Kokkusobivad tooted



115.0669.768 Active L Twist Must matt 338.- €	115.0728.396 Maris Slim Semi Pro Must matt 350.- €
--	---

Belfast



Mõõdud: **595 x 475 mm**
 Kausi mõõtmed: **545 / 410 / 200 mm**
 Paigaldamine: **kapile paigaldatav valamü**
 Materjal: **Fraceram**
 Ventii: **manuaalne ventiil 3½"**
 Ventii juhtimine: **põhjasõela käsitsi avamine**
 Segisti auk: **katteplaadiga ülevool**

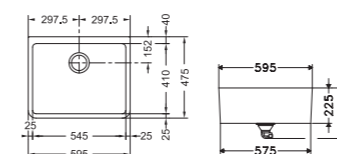

BAK 710

 130.0085.739 Polaarvalge läikiv	490.-
---	-------



Mythos Masterpiece	95
Mythos	97
Maris Quiet	99
Box	100
Maris	104
Aton	108
Smart	110
Fragraniit	
Kubus 2	112
Maris	114
Fraceram	
Kubus X	122



Altpoolt monteeritavad valamud

Altpoolt monteerit-

tavad valamud

Roostevabast terasest

Fragraniit

Fraceram

Tasapinnalised

MYTHOS

MARIS

SMART



Mythos Masterpiece
BXM 210/110-50
95. lk.



Mythos Masterpiece
BXM 210/110-40
95. lk.



Mythos
MYX 110-50
97. lk.



Mythos
MYX 110-45
97. lk.



Maris Quiet
MQX 110-82
99. lk.



Box
BXX 210/110-54
101. lk.



Box
BXX 210/110-50
101. lk.



Box
BXX 210/110-45
101. lk.



Maris
MRX 110-34
107. lk.



Box
BXX 210/110-68
100. lk.



Maris
MRX 160-34-19
105. lk.



Maris
MRX 110-55
105. lk.



Box
BXX 210/110-40
102. lk.



Box
BXX 210/110-34
103. lk.



Maris
MRX 110-70
105. lk.



Maris
MRX 110-50
106. lk.



Maris
MRX 110-45
107. lk.



Maris
MRX 110-40
107. lk.



Aton
ANX 110-34
109. lk.



Maris Quiet
MQX 110-50
99. lk.



Aton
ANX 110-48
109. lk.



Box
BXX 210/110-16
103. lk.



Smart
SRX 110-50
110. lk. **NEW**



Smart
SRX 110-45
111. lk. **NEW**



Smart
SRX 110-40
111. lk. **NEW**



Smart
SRX 110-34
111. lk. **NEW**



Kubus 2
KNG 110-62
113. lk.



Kubus 2
KNG 110-52
113. lk.



Kubus 2
KNG 110-37
113. lk.



Maris
MRG 110-72
114. lk.



Maris
MRG 110-52
115. lk.



Maris
MRG 110-37
115. lk.



Kubus X
KXX 110-71
122. lk. **NEW**



Kubus X
KXX 160-37-12
123. lk. **NEW**



Kubus X
KXX 110-51
123. lk. **NEW**



Kubus X
KXX 110-41
123. lk. **NEW**



Maris
MRG 210-72
117. lk.



Maris
MRG 210-72A
117. lk.



Maris
MRG 210-52
119. lk.



Maris
MRG 210-52A
119. lk.



Maris
MRG 210-37
121. lk.



Maris
MRG 210-37A
121. lk.

Mythos Masterpiece



MYTHOS



Mõõdud: **540 x 450 mm**
 Väljalõige: **510 x 420 mm (R = 10 mm)**
 Kausi mõõtmed: **500 /410 /200 mm**
 Paigaldamine: **SlimTop, tasapinnaline või altpoolt**
 Materjal: **F-Inox roostevaba teras**
 Ventiiil: **eksentriline või manuaalne 3/2" ventiiil**
 Ventiiili juhtimine: **ümmargune vajutusnupp (vajalik 35 mm ava tööpinnas) või põhjasõela käsitsi avamine**
 Ülevool: **katteplaadiga ülevool**
 Tööpind: **min 12 mm paksune**



Lisatarvikud, mis kuuluvad komplekti: **Tavaline metallrest valamule, valamu värvid (A1, G1 või C1)**

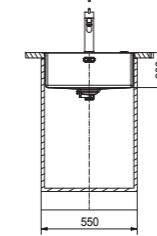
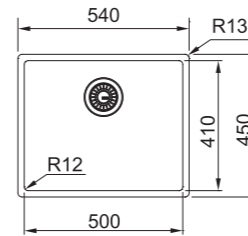

BXM 210/110-50

ümmargune vajutusnupp Hind €

127.0650.363 1447.-
Antratsiit

127.0662.642 1447.-
Vask

127.0662.540 1447.-
Šampanjakuldne

BXM 210/110-50

Manuaalne ventiiil Hind €

127.0672.129 1346.-
Antratsiit

127.0674.363 1346.-
Vask

127.0674.362 1346.-
Šampanjakuldne

Kaasasolevad lisad

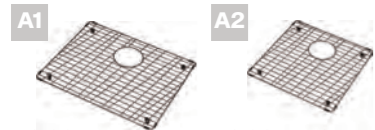

112.0655.470
Tavaline metallrest kraanikausile antratsiit
491 x 401 mm
(50 cm valamud)
203.- €

112.0655.431
Tavaline metallrest kraanikausile antratsiit
391 x 401 mm
(40 cm valamud)
161.- €



112.0655.472
Tavaline metallrest kraanikausile vask
491 x 401 mm
(50 cm valamud)
203.- €

112.0655.468
Tavaline metallrest kraanikausile vask
391 x 401 mm
(40 cm valamud)
161.- €



112.0655.471
Tavaline metallrest kraanikausile šampanjakuldne
491 x 401 mm
(50 cm valamud)
203.- €

112.0655.433
Tavaline metallrest kraanikausile šampanjakuldne
391 x 401 mm
(40 cm valamud)
161.- €

Valikulised lisad

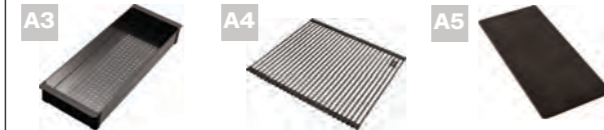

112.0655.239
Nõrutuskauss-roostevaba teras antratsiit plastik käepidemega
157 x 429 x 54 mm
169.- €

112.0655.342
Rullmatt painduv antratsiit
468 x 440 mm
304.- €

112.0676.854
Plastikust lõikepind
240 x 429 x 15 mm
177.- €

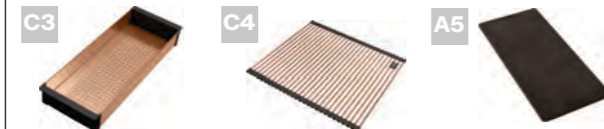

112.0655.341
Nõrutuskauss-roostevaba teras vask plastik käepidemega
157 x 429 x 54 mm
169.- €

112.0655.344
Rullmatt painduv vask
468 x 440 mm
304.- €

112.0676.854
Plastikust lõikepind
240 x 429 x 15 mm
177.- €

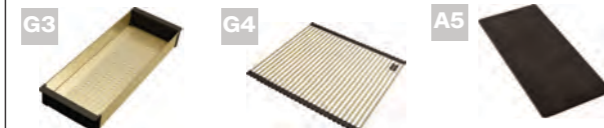

112.0655.240
Nõrutuskauss-roostevaba teras šampanjakuldne plastik käepidemega
157 x 429 x 54 mm
169.- €

112.0655.343
Rullmatt painduv šampanjakuldne
468 x 440 mm
304.- €

112.0676.854
Plastikust lõikepind
240 x 429 x 15 mm
177.- €

Kokkusobivad tooted



Mythos Masterpiece segistid rohkem 135. lk.



Atlas Neo segistid rohkem 143. lk.



Eos Neo segistid rohkem 145. lk.



Atlas Neo Seebidosaatiorid rohkem 175. lk.

MYTHOS



Mõõdud: **440 x 450 mm**
 Väljalõige: **410 x 420 mm (R = 10 mm)**
 Kausi mõõtmed: **400 /410 /200 mm**
 Paigaldamine: **SlimTop, tasapinnaline või altpoolt**
 Materjal: **F-Inox roostevaba teras**
 Ventiiil: **eksentriline või manuaalne 3/2" ventiiil**
 Ventiiili juhtimine: **ümmargune vajutusnupp (vajalik 35 mm ava tööpinnas) või põhjasõela käsitsi avamine**
 Ülevool: **katteplaadiga ülevool**
 Tööpind: **min 12 mm paksune**

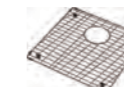

Lisatarvikud, mis kuuluvad komplekti: **Tavaline metallrest valamule, valamu värvid (A2, G2 või C2)**

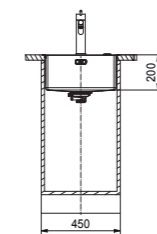
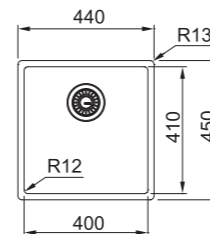

BXM 210/110-40

ümmargune vajutusnupp Hind €

127.0650.362 1350.-
Antratsiit

127.0662.649 1350.-
Vask

127.0662.648 1350.-
Šampanjakuldne

BXM 210/110-50

Manuaalne ventiiil Hind €

127.0674.537 1246.-
Antratsiit

127.0674.583 1246.-
Vask

127.0674.582 1246.-
Šampanjakuldne

Altpoolt monteeritav



Valikulised lisad

- | | | | | |
|--|---|--|--|---|
| 
01
112.0659.398
Roostevabast terasest nõrutuskauss
plastkäepidemetega
159 x 416 x 54 mm
66.- € | 
02
112.0602.288
Rv Mobiilne nõruti plastik raamis
298 x 412x17 mm
108.- € | 
03
112.0591.082
Lõikelaud Paper-Stone Slate grey
180x412x13 mm
139.- € | 
04
112.0591.081
Rullmatt paindub
252 x 424 mm
68.- € | 
05
ALL-IN
5 erinevat komplekti ALL IN
(rohkem lk 125) valamule: 340 x 540 mm
135.- ... 258.- € |
|--|---|--|--|---|

Kokkusobivad tooted

- | |
|---|
| 
115.0521.438
Atlas Neo Roostevabast terasest segisti
324.- € |
|---|

MYTHOS
01 02
03 04
05



Mõõdud: **540 x 440 mm (R = 10 mm)**
 Väljalõige: **500 x 400 mm (R = 25mm)**
 Kausi mõõtmed: **500 /400 /200 mm (R = 25 mm)**
 Paigaldamine: **altpoolt monteeritav**
 Materjal: **roostevaba teras poleeritud**
 Ventii: **integreeritud ventii**
 Ventii juhtimine:
vajutusnupp ümmargune roostevaba teras
 Nupu kasutamiseks on vaja 35 mm auku
 Ülevool: **katteplaadiga ülevool**

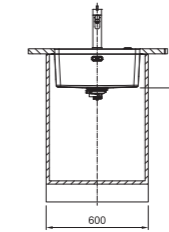
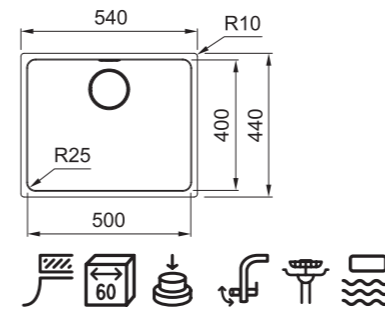

MYX 110-50

ümmargune vajutusnupp
Hind €
122.0601.316 **631.-**
 Roostevaba teras

MYTHOS
01 02
03 04
05



Mõõdud: **490 x 440 mm (R = 10 mm)**
 Väljalõige: **450 x 400 mm (R = 25mm)**
 Kausi mõõtmed: **450 /400 /200 mm (R = 25 mm)**
 Paigaldamine: **altpoolt monteeritav**
 Materjal: **roostevaba teras poleeritud**
 Ventii: **integreeritud ventii**
 Ventii juhtimine:
vajutusnupp ümmargune roostevaba teras
 Nupu kasutamiseks on vaja 35 mm auku
 Ülevool: **katteplaadiga ülevool**

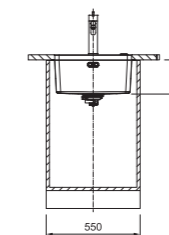
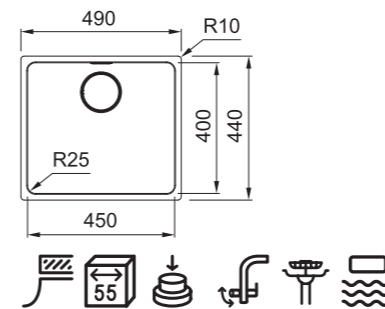

MYX 110-45

ümmargune vajutusnupp
Hind €
122.0601.315 **610.-**
 Roostevaba teras

Maris Quiet

Altpoolt monteeritav

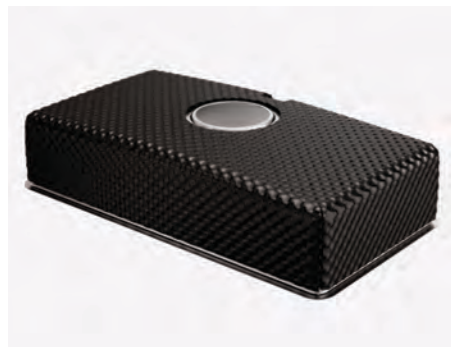

Valikulised lisad



01
ALL-IN
 5 erinevat komplekti
 ALL IN
 (rohkem lk 125) vala-
 mule: 340 x 540 mm
135.- ... 258.- €



02
112.0030.882
 Rullmatt paindub
 468 x 420 mm
86.- €

MARIS
 01 02



Mõõdud: **860 x 460 mm (R = 40 mm)**
 Väljalõige: **820 x 424 mm (R = 20mm)**
 Kausi mõõtmed: **820 / 420 / 190 mm (R = 20 mm)**
 Paigaldamine: **altpoolt monteeritav**
 Materjal: **roostevaba teras poleeritud**
 Ventii: **162 mm prügi väljalaskeava läbimõõt, suur sangadega prügikorv muudab jäätmete ja kin-
 nijäänud toidu äraviskamise lihtsaks**
 Ülevool: **katteplaadiga ülevool**

Saadaval kuni juunini 2026

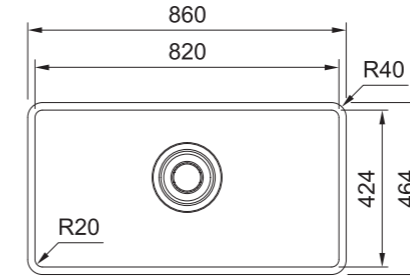

MQX 110-82

Manuaalne ventiil

Hind €

122.0694.479
 Roostevaba teras

727.-

MARIS
 01 02



Mõõdud: **540 x 440 mm (R = 40 mm)**
 Väljalõige: **500 x 400 mm (R = 20mm)**
 Kausi mõõtmed: **500 / 400 / 188 mm (R = 20 mm)**
 Paigaldamine: **altpoolt monteeritav**
 Materjal: **roostevaba teras poleeritud**
 Ventii: **162 mm prügi väljalaskeava läbimõõt, suur sangadega prügikorv muudab jäätmete ja kin-
 nijäänud toidu äraviskamise lihtsaks**
 Ülevool: **katteplaadiga ülevool**

Saadaval kuni juunini 2026

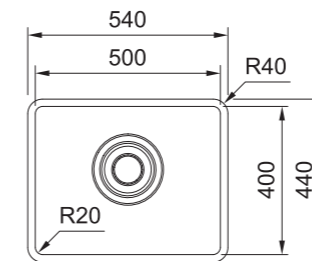

MQX 110-50

Manuaalne ventiil

Hind €

122.0694.477
 Roostevaba teras

598.-

Altpoolt monteeritav



Valikulised lisad

- | | | | |
|--|---|--|---|
| 01

112.0080.355
Rullmatt paindub
468 x 440 mm
90.- € | 02

112.0204.360
Rv Mobiilne nõruti
plastik raamis
326 x 440 x 23 mm
129.- € | 03

112.0394.981
Roostevabast
terasest nõrtuskauss
plastkäepidemetega
429 x 156 mm
116.- € | 04

112.0619.946
Andy Chef - tarvikute
komplekt
408 x 133 x 200 mm
493.- € |
|--|---|--|---|

Kokkusobivad tooted

- | | |
|---|--|
| 
115.0521.438
Atlas Neo
Roostevabast
terasest segisti
324.- € | 
115.0728.388
Maris Slim J
Kroom
248.- € |
|---|--|

MARIS



Mõõdud: **725 x 450 mm**
Väljalõige: **695 x 420 mm (R = 10 mm)**
Kausi mõõtmed: **685 / 410 / 200 mm**
Paigaldamine: **SlimTop, tasapinnaline või altpoolt**
Ventii: **integreeritud või 3½" ventiil**
Ventii juhtimine: **vajutusnupp ümmargune roostevaba teras**
Nupu kasutamiseks on vaja 35 mm auku
Ülevool: **katteplaadiga ülevool**
Tööpind: **min 12 mm paksune**

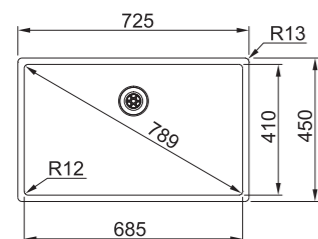

BXX 210/110-68

Valamu põhjaga integreeritud ekstsentrilapiga valamu, mida juhitakse nupuga. Hind €
127.0539.907 **548.-**
Roostevaba teras

Valamu käsitsi ventiiiga, mida saab tõsta/langetada manuaalselt. Täienduste hulgas on ka jäätmepurustusmasinad. Hind €
127.0539.906 **496.-**
Roostevaba teras

MARIS



Mõõdud: **540 x 450 mm**
Väljalõige: **510 x 420 mm (R = 10 mm)**
Kausi mõõtmed: **500 / 410 / 200 mm**
Paigaldamine: **SlimTop, tasapinnaline või altpoolt**
Ventii: **integreeritud või 3½" ventiil**
Ventii juhtimine: **vajutusnupp ümmargune roostevaba teras**
Nupu kasutamiseks on vaja 35 mm auku
Ülevool: **katteplaadiga ülevool**
Tööpind: **min 12 mm paksune**

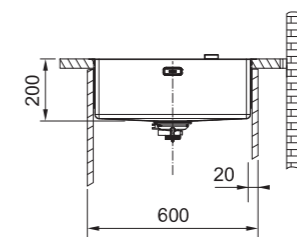
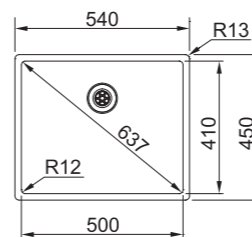

BXX 210/110-50

Valamu põhjaga integreeritud ekstsentrilapiga valamu, mida juhitakse nupuga. Hind €
127.0375.273 **473.-**
Roostevaba teras

Valamu käsitsi ventiiiga, mida saab tõsta/langetada manuaalselt. Täienduste hulgas on ka jäätmepurustusmasinad. Hind €
127.0374.206 **415.-**
Roostevaba teras

MARIS



Mõõdud: **490 x 450 mm**
Väljalõige: **460 x 420 mm (R = 10 mm)**
Kausi mõõtmed: **450 / 410 / 200 mm**
Paigaldamine: **SlimTop, tasapinnaline või altpoolt**
Ventii: **integreeritud või 3½" ventiil**
Ventii juhtimine: **vajutusnupp ümmargune roostevaba teras**
Nupu kasutamiseks on vaja 35 mm auku
Ülevool: **katteplaadiga ülevool**
Tööpind: **min 12 mm paksune**

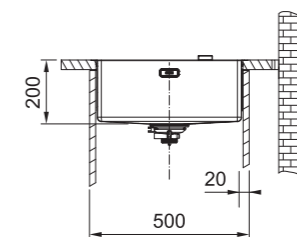
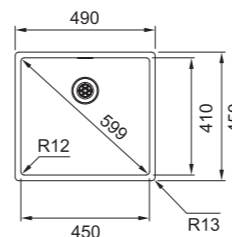

BXX 210/110-45

Valamu põhjaga integreeritud ekstsentrilapiga valamu, mida juhitakse nupuga. Hind €
127.0375.257 **455.-**
Roostevaba teras

Valamu käsitsi ventiiiga, mida saab tõsta/langetada manuaalselt. Täienduste hulgas on ka jäätmepurustusmasinad. Hind €
127.0372.489 **399.-**
Roostevaba teras

Altpoolt monteeritav



Valikulised lisad

- | | | | | |
|---|---|--|---|---|
| 01

112.0080.355
Rollmatt paindub
468 x 440 mm
90.- € | 02

112.0204.360
Rv Mobiilne nõruti
plastik raamis
326 x 440 x 23 mm
129.- € | 03

112.0394.981
Roostevabast
terasest nõrutuskauss
plastikäepidemetega
429 x 156 mm
116.- € | 04

112.0619.946
Andy Chef -
tarvikute komplekt
408 x 133 x 200 mm
493.- € | 05

112.0520.497
Roostevabast
terasest perforeeritud
põhjaga kandik
172x412x55mm
82.- € |
|---|---|--|---|---|

Kokkusobivad tooted

- 115.0521.438
Atlas Neo
Roostevabast
terasest segisti
324.- €

MARIS



Mõõdud: **440 x 450 mm**
Väljalõige: **410 x 420 mm (R = 10 mm)**
Kausi mõõtmed: **400 /410 /200 mm**
Paigaldamine: **SlimTop, tasapinnaline või altpoolt**
Ventil: **integreeritud või 3 1/2" ventiil**
Ventili juhtimine: **vajutusnupp ümmargune roostevaba teras**
Nupu kasutamiseks on vaja 35 mm auku
Ülevool: **katteplaadiga ülevool**
Tööpind: **min 12 mm paksune**

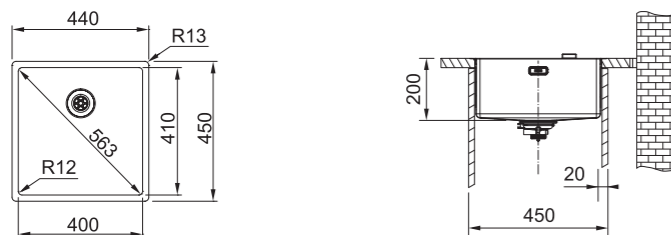

BXX 210/110-40

Valamu põhjaga integreeritud ekstsentriklapiga valam, mida juhitakse nupuga. Hind €
127.0375.252 445.-
Roostevaba teras

Valamu käsitsi ventilliga, mida saab tõsta/langetada manuaalselt. Täienduste hulgas on ka jäätmepurustus masinad. Hind €
127.0375.284 387.-
Roostevaba teras

MARIS



Mõõdud: **380 x 450 mm**
Väljalõige: **350 x 420 mm (R = 10 mm)**
Kausi mõõtmed: **340 /410 /200 mm**
Paigaldamine: **SlimTop, tasapinnaline või altpoolt**
Ventil: **manuaalne 3 1/2" ventiil**
Ventili juhtimine: **vajutusnupp ümmargune roostevaba teras**
Nupu kasutamiseks on vaja 35 mm auku
Ülevool: **katteplaadiga ülevool**
Tööpind: **min 12 mm paksune**

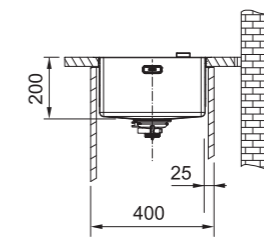
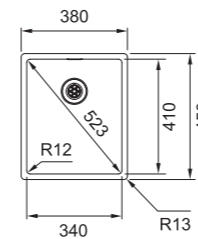

BXX 210/110-34

Valamu põhjaga integreeritud ekstsentriklapiga valam, mida juhitakse nupuga. Hind €
127.0374.687 435.-
Roostevaba teras

Valamu käsitsi ventilliga, mida saab tõsta/langetada manuaalselt. Täienduste hulgas on ka jäätmepurustus masinad. Hind €
127.0372.501 370.-
Roostevaba teras

MARIS



Mõõdud: **200 x 450 mm**
Väljalõige: **170 x 420 mm (R = 10 mm)**
Kausi mõõtmed: **160 /410 /200 mm**
Paigaldamine: **SlimTop, tasapinnaline või altpoolt**
Ventil: **integreeritud ventiil**
Ventili juhtimine: **vajutusnupp ümmargune roostevaba teras**
Nupu kasutamiseks on vaja 35 mm auku
Ülevool: **katteplaadiga ülevool**
Tööpind: **min 12 mm paksune**

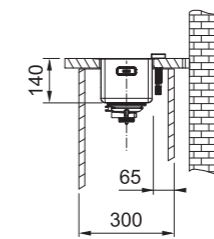
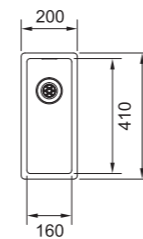

BXX 210/110-16

Valamu põhjaga integreeritud ekstsentriklapiga valam, mida juhitakse nupuga. Hind €
122.0374.674 381.-
Roostevaba teras

Andy Chef



Enne paigaldamist peab tööpinnas olema väljalõige ülevoolu paigaldamiseks.

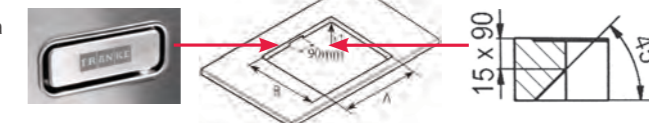

Altpoolt monteeritav



MARIS

01 02
03 04



Mõõdud: **595 x 440 mm**
Väljalõige: **555 x 400 mm (R=16mm)**
Kausi mõõtmed: **340/400/180 + 190/400/130 mm**
Paigaldamine: **altpoolt monteeritav**
Materjal: **roostevaba teras poleeritud**
Ventil: **manuaalne 3½" ventiil**
Ventili juhtimine: **käsitsi avamine/ sulgemine**
Ülevool: **katteplaadiga ülevool**
Tööpind: **min 20 mm paksune**

MRX 160-34-19

Manuaalne ventiil

Hind €

122.0594.258 **612.-**
Roostevaba teras

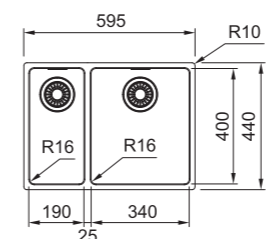

MARIS

01 02
03 04



Mõõdud: **740 x 440 mm**
Väljalõige: **700 x 400 mm (R=16mm)**
Kausi mõõtmed: **700/400/180 mm**
Paigaldamine: **altpoolt monteeritav**
Materjal: **roostevaba teras poleeritud**
Ventil: **manuaalne 3½" ventiil**
Ventili juhtimine: **käsitsi avamine/ sulgemine**
Ülevool: **katteplaadiga ülevool**
Tööpind: **min 20 mm paksune**

MRX 110-70

Manuaalne ventiil

Hind €

122.0531.911 **397.-**
Roostevaba teras

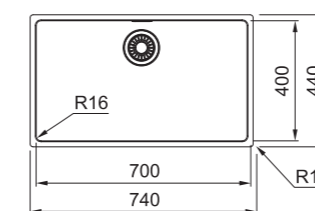

MARIS

01 02
03 04



Mõõdud: **590 x 440 mm**
Väljalõige: **550 x 400 mm (R=16mm)**
Kausi mõõtmed: **550/400/180 mm**
Paigaldamine: **altpoolt monteeritav**
Materjal: **roostevaba teras poleeritud**
Ventil: **manuaalne 3½" ventiil**
Ventili juhtimine: **käsitsi avamine/ sulgemine**
Ülevool: **katteplaadiga ülevool**
Tööpind: **min 20 mm paksune**

MRX 110-55

Manuaalne ventiil

Hind €

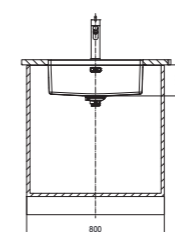
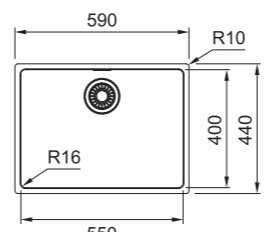

122.0553.947 **338.-**
Roostevaba teras



Valikulised lisad

- 01**  **112.0520.497**
Roostevabast terasest perforeeritud põhjaga kandik 172x412x55 mm **80.- €**
- 02**  **112.0188.651**
Rv Mobiilne nõruti plastik raamis 342 x 430 x 22 mm **120.- €**
- 03**  **112.0030.882**
Rollmatt paindub 468 x 420 mm **86.- €**
- 04**  **ALL-IN**
5 erinevat komplekti ALL IN (rohkem lk 125) valamule: 340 x 540 mm **135.- ... 258.- €**

Kokkusobivad tooted

-  **115.0521.438**
Atlas Neo Roostevabast terasest segisti **324.- €**
-  **115.0728.393**
Maris Slim kroom segisti **241.- €**

Altpoolt monteeritav



Valikulised lisad

- 01**



112.0520.497
Roostevabast terasest perforeeritud põhjaga kandik
172x412x55 mm
82.- €
- 02**



112.0188.651
Rv Mobiilne nõruti plastik raamis
342 x 430 x 22 mm
120.- €
- 03**





112.0030.882
Rullmatt painduv
468 x 420 mm
86.- €
- 04**



ALL-IN
5 erinevat komplekti ALL-IN (rohkem lk 125) valamule: 340 x 540 mm
135.- ... 258.- €

Kokkusobivad tooted

- 

115.0521.438
Atlas Neo
Roostevabast terasest segisti
324.- €
- 

115.0728.393
Maris Slim kroom segisti
241.- €

MARIS



Mõõdud: **540 x 440 mm**
Väljalõige: **500 x 400 mm (R=16mm)**
Kausi mõõtmed: **500/400/180 mm**
Paigaldamine: **altpoolt monteeritav**
Materjal: **roostevaba teras poleeritud**
Ventii: **manuaalne 3½" ventiil**
Ventii juhtimine: **käsitsi avamine/ sulgemine**
Ülevool: **katteplaadiga ülevool**
Tööpind: **min 20 mm paksune**

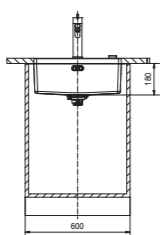
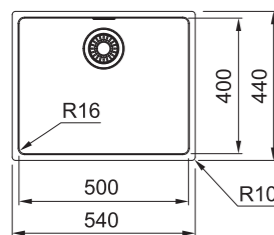

MRX 110-50

 Manuaalne ventiil
Hind € **324.-**
 **122.0531.808**
Roostevaba teras

MARIS



Mõõdud: **490 x 440 mm**
Väljalõige: **450 x 400 mm (R=16mm)**
Kausi mõõtmed: **450/400/180 mm**
Paigaldamine: **altpoolt monteeritav**
Materjal: **roostevaba teras poleeritud**
Ventii: **manuaalne 3½" ventiil**
Ventii juhtimine: **käsitsi avamine/ sulgemine**
Ülevool: **katteplaadiga ülevool**
Tööpind: **min 20 mm paksune**

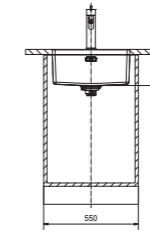
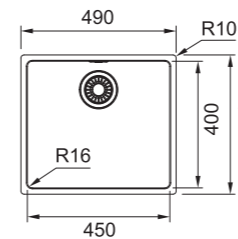

MARIS



Mõõdud: **440 x 440 mm**
Väljalõige: **400 x 400 mm (R=16mm)**
Kausi mõõtmed: **400/400/180 mm**
Paigaldamine: **altpoolt monteeritav**
Materjal: **roostevaba teras poleeritud**
Ventii: **manuaalne 3½" ventiil**
Ventii juhtimine: **käsitsi avamine/ sulgemine**
Ülevool: **katteplaadiga ülevool**
Tööpind: **min 20 mm paksune**

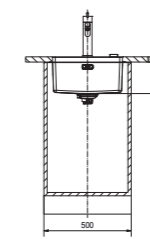
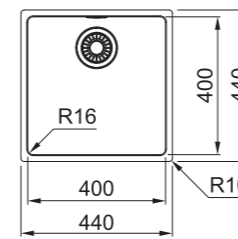



MARIS



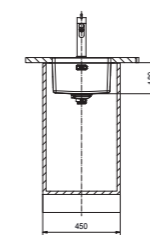
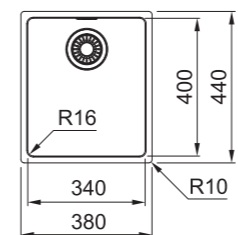

Mõõdud: **380 x 440 mm**
Väljalõige: **340 x 400 mm (R=16mm)**
Kausi mõõtmed: **340/400/180 mm**
Paigaldamine: **altpoolt monteeritav**
Materjal: **roostevaba teras poleeritud**
Ventii: **manuaalne 3½" ventiil**
Ventii juhtimine: **käsitsi avamine/ sulgemine**
Ülevool: **katteplaadiga ülevool**
Tööpind: **min 20 mm paksune**





MRX 110-45

 Manuaalne ventiil
Hind € **310.-**
 **122.0553.943**
Roostevaba teras

MRX 110-40

 Manuaalne ventiil
Hind € **296.-**
 **122.0531.643**
Roostevaba teras

MRX 110-34

 Manuaalne ventiil
Hind € **288.-**
 **122.0531.850**
Roostevaba teras



MARIS
01 02
03 04



Mõõdud: 510 x 430 mm
Väljalõige: Šablooni järgi
Kausi mõõtmed: 480 / 400 / 190 mm
Paigaldamine: altpoolt monteeritav
Materjal: roostevaba teras poleeritud
Ventiil: nupuga avatav 3½" ventiil
Ventiili juhtimine: ümar keeratav nupp sõela avamiseks või sulgemiseks
Ülevool: katteplaadiga ülevool
Tööpind: min 20 mm paksune

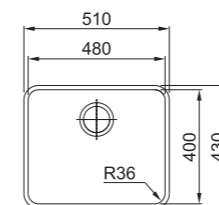

MARIS
01 02
03 04



Mõõdud: 370 x 430 mm
Väljalõige: Šablooni järgi
Kausi mõõtmed: 340 / 400 / 190 mm
Paigaldamine: altpoolt monteeritav
Materjal: roostevaba teras poleeritud
Ventiil: nupuga avatav 3½" ventiil
Ventiili juhtimine: ümar keeratav nupp sõela avamiseks või sulgemiseks
Ülevool: katteplaadiga ülevool
Tööpind: min 20 mm paksune

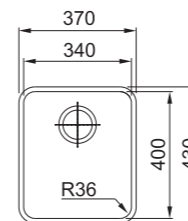

ANX 110-48

Ekstsentriline nupp

Hind €

122.0336.883 215.-
Roostevaba teras

ANX 110-34

Ekstsentriline nupp

Hind €

122.0336.885 199.-
Roostevaba teras

Valikulised lisad



01

112.0520.497
Roostevabast terasest perforeeritud põhjaga kandik 172x412x55 mm
82.- €



02

112.0188.651
Rv Mobiilne nõruti plastik raamis 342 x 430 x 22 mm
120.- €



03

112.0030.882
Rullmatt painduv 468 x 420 mm
86.- €



04

ALL-IN
5 erinevat komplekti ALL IN (rohkem lk 125) valamule: 340 x 540 mm
135.- ... 258.- €

Kokkusobivad tooted



115.0521.438
Atlas Neo Roostevabast terasest segisti
324.- €



115.0728.393
Maris Slim kroom segisti
241.- €

Altpoolt monteeritav



Valikulised lisad



01
112.0188.651
Rv Mobiilne nõruti
plastik raamis
342 x 430 x 22 mm
120.- €

02
ALL-IN
5 erinevat komplekti
ALL IN
(rohkem lk 125) vala-
mule: 340 x 540 mm
135.- ... 258.- €

Kokkusobivad tooted



115.0521.438
Atlas Neo
Roostevabast
terasest segisti
324.- €



115.0728.393
Maris Slim kroom
segisti
241.- €

SMART

01 02

NEW



Mõõdud: **541 x 441 mm**
Kausi mõõtmed: **500/400/180 mm**
Paigaldamine: **altpoolt monteeritav**
Materjal: **roostevaba teras poleeritud**
Ventiil: **manuaalne 3½" ventiil**
Ventiili juhtimine: **käsitsi avamine/ sulgemine**
Ülevool: **katteplaadiga ülevool**

SRX 110-50

Manuaalne ventiil

127.0708.310
Roostevaba teras
Hind € 169.-

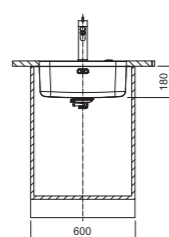
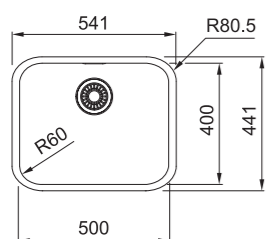

SMART

01 02

NEW



Mõõdud: **482 x 432 mm**
Kausi mõõtmed: **450/400/190 mm**
Paigaldamine: **altpoolt monteeritav**
Materjal: **roostevaba teras poleeritud**
Ventiil: **manuaalne 3½" ventiil**
Ventiili juhtimine: **käsitsi avamine/ sulgemine**
Ülevool: **katteplaadiga ülevool**

SRX 110-45

Manuaalne ventiil

122.0744.962
Roostevaba teras
Hind € 159.-

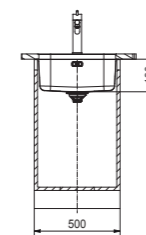
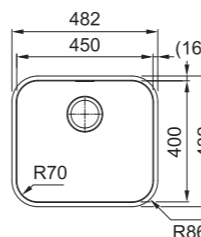

SMART

01 02

NEW



Mõõdud: **428 x 428 mm**
Kausi mõõtmed: **400/400/190 mm**
Paigaldamine: **altpoolt monteeritav**
Materjal: **roostevaba teras poleeritud**
Ventiil: **manuaalne 3½" ventiil**
Ventiili juhtimine: **käsitsi avamine/ sulgemine**
Ülevool: **katteplaadiga ülevool**

SRX 110-40

Manuaalne ventiil

122.0744.950
Roostevaba teras
Hind € 149.-

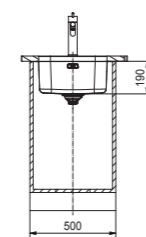
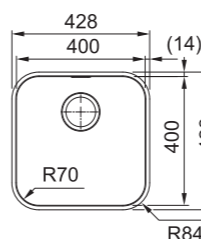

SMART

01 02

NEW



Mõõdud: **368 x 428 mm**
Kausi mõõtmed: **341/401/180 mm**
Paigaldamine: **altpoolt monteeritav**
Materjal: **roostevaba teras poleeritud**
Ventiil: **manuaalne 3½" ventiil**
Ventiili juhtimine: **käsitsi avamine/ sulgemine**
Ülevool: **katteplaadiga ülevool**

SRX 110-34

Manuaalne ventiil

122.0744.948
Roostevaba teras
Hind € 139.-

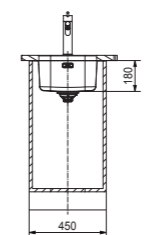
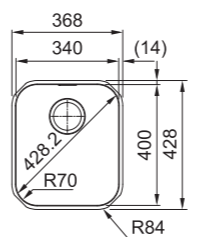

Kubus 2

Altpoolt monteeritav



Valikulised lisad



01
112.0066.060
Roostevabast terasest nõrutuskauss plastkäepidemetega
156 x 417 x 54 mm
116.- €



02
112.0256.867
Rullmatt painduv
298 x 407 mm
48.- €



03 **NEW**
112.0747.050
Puidust lõikelaud
438x240x23mm
70.- €



04
112.0204.360
Rv Mobiilne nõruti plastik raamis
326 x 440 x 23 mm
129.- €



05
112.0473.656
Augufrees 35mm
Fragraniit ja Tektoniit valamutele
6.- €

Kokkusobivad tooted



115.0669.768
Active L Twist
Must matt
338.- €



115.0728.396
Maris Slim Semi Pro
Must matt
350.- €

MYTHOS



Mõõdud: **760 x 460 mm**
Väljalõige: **720 x 420 mm (R=10 mm)**
Kausi mõõtmed: **620 /420 /200 mm**
Paigaldamine: **altpoolt monteeritav**
Kausi asukoht: **pööratav**
Materjal: **Fragraniit**
Ventiiil: **sealhulgas ventiil 3½" vajutusnupuga**
Ventiiili juhtimine:
Vajutusnupp ümmargune roostevaba teras
Ventiiil kaas: **Katteplaadiga ülevool**
Ülevool: **katteplaadiga ülevool**
Segisti auk: **ilma aukudeta (2 x 35 mm altpoolt puuritud augud)**
Erimärkused: **2-tasandilise kausi tarvikud**

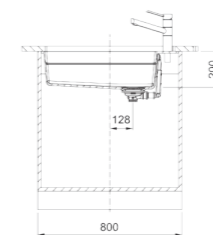
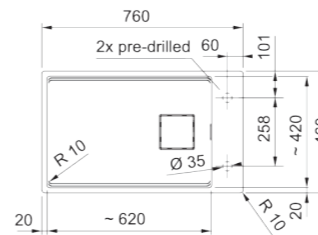

MYTHOS



Mõõdud: **560 x 460 mm**
Väljalõige: **520 x 420 mm (R=10 mm)**
Kausi mõõtmed: **520 /420 /200 mm**
Paigaldamine: **altpoolt monteeritav**
Materjal: **Fragraniit**
Ventiiil: **sealhulgas ventiil 3½" vajutusnupuga**
Ventiiili juhtimine: **vajutusnupp ümmargune roostevaba teras**
Ventiiil kaas: **Katteplaadiga ülevool**
Ülevool: **katteplaadiga ülevool**
Segisti auk: **katteplaadiga ülevool**
Erimärkused: **2-tasandilise kausi tarvikud**

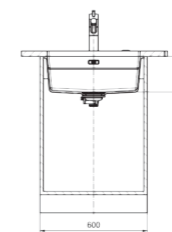
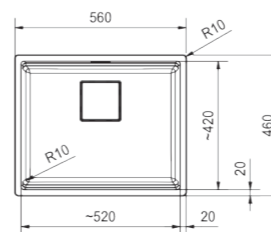

MYTHOS



Mõõdud: **410 x 460 mm**
Väljalõige: **370 x 420 mm (R=10 mm)**
Kausi mõõtmed: **370 /420 /200 mm**
Paigaldamine: **altpoolt monteeritav**
Materjal: **Fragraniit**
Ventiiil: **sealhulgas ventiil 3½" vajutusnupuga**
Ventiiili juhtimine: **vajutusnupp ümmargune roostevaba teras**
Ventiiil kaas: **Katteplaadiga ülevool**
Ülevool: **katteplaadiga ülevool**
Segisti auk: **katteplaadiga ülevool**
Erimärkused: **2-tasandilise kausi tarvikud**

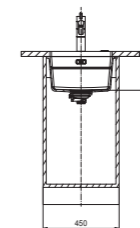
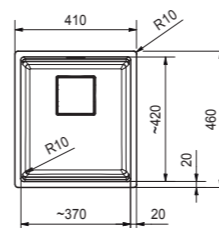

KNG 110-62

ümmargune vajutusnupp

	Hind €
125.0627.321 Must matt	570.-
125.0512.515 Onyx	556.-

KNG 110-52

ümmargune vajutusnupp

	Hind €
125.0627.319 Must matt	469.-
125.0512.504 Onyx	455.-
125.0715.491 Slate Grey	455.-
125.0512.507 Kivihall	455.-
125.0512.505 Kašmiir	455.-
125.0512.506 Polaarvalge	455.-

KNG 110-37

ümmargune vajutusnupp

	Hind €
125.0627.320 Must matt	435.-
125.0512.449 Onyx	419.-
125.0715.492 Slate Grey	419.-
125.0512.452 Kivihall	419.-
125.0512.450 Kašmiir	419.-
125.0512.451 Polaarvalge	419.-

Maris

Altpoolt monteeritav



Valikulised lisad

- | | | | |
|--|--|---|---|
| 01 | 02 | 03 | 04 |
| | | | |
| 112.0030.882
Rollmatt paindub
468 x 420 mm
86.- € | 112.0188.651
Rv Mobiilne nõruti
plastik raamis
342 x 430 x 22 mm
120.- € | 112.0473.656
Augufrees 35mm
Fragraniit ja
Tektoniit
valamutele
6.- € | ALL-IN
5 erinevat komplekti ALL IN
(rohkem lk 125) valamute:
340 x 540 mm
135.- ... 258.- € |

Kokkusobivad tooted

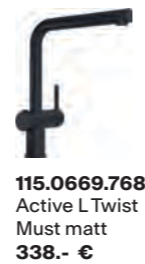

115.0669.768
Active L Twist
Must matt
338.- €

MARIS

- | | |
|----|----|
| 01 | 02 |
| 03 | 04 |
| 05 | |



Mõõdud: **753 x 433 mm**
Väljalõige: **720 x 400 mm (R=20mm)**
Kausi mõõtmed: **720 / 400 / 200 mm**
Paigaldamine: **altpoolt monteeritav**
Materjal: **Fragraniit**
Ventiil: **koos ventiiliga 3½"**
Ventiili juhtimine: **vajutusnupp või pöördnupp või käsitsi sõela avamine/sulgmine**
Ventiil kaas: **ümmargune**
Ülevool: **katteplaadiga ülevool**
Segisti auk: **ei**

MRG 110-72

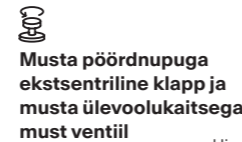

Musta pöördnupuga ekstsentriline klapp ja musta ülevoolukaitsega must ventiil

Hind €	Hind €
125.0683.236	125.0683.235
Must matt	Must matt
411.-	399.-



Käsitsi 3½" ventiil musta klapi, ülevoolude ja klapikaanega



Manuaalventiil roostevabast terasest klapikaanega

Hind €	Hind €
125.0683.189	125.0683.185
Must matt	Onyx
399.-	399.-
125.0715.494	125.0683.186
Slate Grey	Kivihall
399.-	399.-
125.0683.188	125.0683.187
Kašmiir	Polaarvalge
399.-	399.-

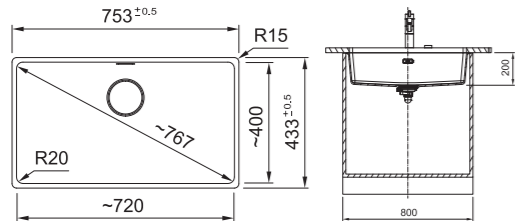

MARIS

- | | |
|----|----|
| 01 | 02 |
| 03 | 04 |
| 05 | |



Mõõdud: **553 x 433 mm**
Väljalõige: **520 x 400 mm (R=20mm)**
Kausi mõõtmed: **520 / 400 / 200 mm**
Paigaldamine: **altpoolt monteeritav**
Materjal: **Fragraniit**
Ventiil: **koos ventiiliga 3½"**
Ventiili juhtimine: **vajutusnupp või pöördnupp või käsitsi sõela avamine/sulgmine**
Ventiil kaas: **ümmargune**
Ülevool: **katteplaadiga ülevool**
Segisti auk: **ei**

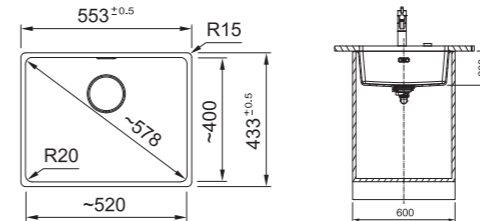

MRG 110-52



Musta pöördnupuga ekstsentriline klapp ja musta ülevoolukaitsega must ventiil

Hind €	Hind €
125.0683.234	125.0683.233
Must matt	Must matt
389.-	375.-

Käsitsi 3½" ventiil musta klapi, ülevoolude ja klapikaanega



Ekstsentriline klapp ümmarguse terasest nupu ja roostevabast terasest klapikaanega

Hind €	Hind €
125.0683.105	125.0683.184
Must matt	Must matt
475.-	375.-

Manuaalventiil roostevabast terasest klapikaanega

125.0683.101	125.0683.140
Onyx	Onyx
461.-	362.-

125.0715.495	125.0715.496
Slate Grey	Slate Grey
461.-	362.-

125.0683.102	125.0683.181
Kivihall	Kivihall
461.-	362.-

125.0683.104	125.0683.183
Kašmiir	Kašmiir
461.-	362.-

125.0683.103	125.0683.182
Polaarvalge	Polaarvalge
461.-	362.-

MARIS

- | | |
|----|----|
| 01 | 02 |
| 03 | 04 |
| 05 | |



Mõõdud: **403 x 433 mm**
Väljalõige: **370 x 400 mm (R=20mm)**
Kausi mõõtmed: **370 / 400 / 200 mm**
Paigaldamine: **altpoolt monteeritav**
Materjal: **Fragraniit**
Ventiil: **koos ventiiliga 3½"**
Ventiili juhtimine: **vajutusnupp või pöördnupp või käsitsi sõela avamine/sulgmine**
Ventiil kaas: **ümmargune**
Ülevool: **katteplaadiga ülevool**
Segisti auk: **ei**

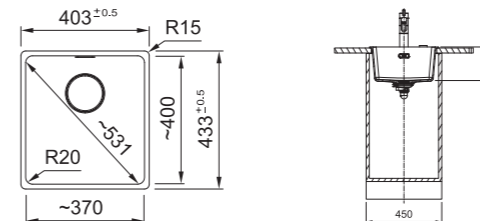

MRG 110-37



Musta pöördnupuga ekstsentriline klapp ja musta ülevoolukaitsega must ventiil

Hind €	Hind €
125.0683.232	125.0683.231
Must matt	Must matt
338.-	330.-

Käsitsi 3½" ventiil musta klapi, ülevoolude ja klapikaanega



Ekstsentriline klapp ümmarguse terasest nupu ja roostevabast terasest klapikaanega

Hind €	Hind €
125.0683.060	125.0683.139
Must matt	Must matt
415.-	330.-

Manuaalventiil roostevabast terasest klapikaanega

125.0683.056	125.0683.135
Onyx	Onyx
415.-	316.-

125.0715.497	125.0715.498
Slate Grey	Slate Grey
415.-	316.-

125.0683.057	125.0683.136
Kivihall	Kivihall
415.-	316.-

125.0683.059	125.0683.138
Kašmiir	Kašmiir
415.-	316.-

125.0683.058	125.0683.137
Polaarvalge	Polaarvalge
415.-	316.-

Maris

Tasapinnaline



Valikulised lisad

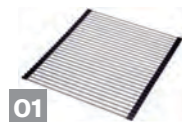

01
112.0030.882
Rullmatt paindub
468 x 420 mm
86.- €



02
112.0188.651
Rv Mobiilne nõruti
plastik raamis
342 x 430 x 22 mm
120.- €



03
112.0473.656
Augufrees 35mm
Fragraniit ja
Tektoniit
valamutele
6.- €



04
ALL-IN
5 erinevat komplekti ALL IN
(rohkem lk 125) valamule:
340 x 540 mm
135.- ... 258.- €

Kokkusobivad tooted



115.0669.768
Active L Twist
Must matt
338.- €



Mõõdud: **753 x 433 mm**
Väljalõige: **vastavalt juhisele**
Kausi mõõtmed: **720 / 400 / 200 mm**
Paigaldamine: **tasapinnaline**
Materjal: **Fragraniit**
Ventiil: **koos ventiiliga 3½"**
Ventiili juhtimine: **manuaalne 3½"** ventiil
Ventiil kaas: **ümmargune**
Ülevool: **katteplaadiga ülevool**
Segisti auk: **ei**

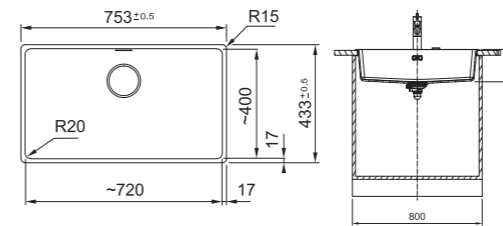

MRG 210-72

 Käsitsi 3½" ventiil musta klapi, ülevoolude ja klapikaanega

135.0683.046
Must matt

Hind €
415.-



Mõõdud: **753 x 503 mm**
Väljalõige: **vastavalt juhisele**
Kausi mõõtmed: **720 / 400 / 200 mm**
Paigaldamine: **tasapinnaline**
Materjal: **Fragraniit**
Ventiil: **koos ventiiliga 3½"**
Ventiili juhtimine: **vajutusnupp või pöördnupp või käsitsi sõela avamine/sulgmine**
Ventiil kaas: **ümmargune**
Ülevool: **katteplaadiga ülevool**
Segisti auk: **ilma aukudeta**
(5 x 35 mm altpoolt puuritud augud)

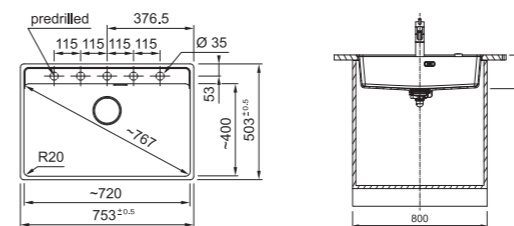

MRG 210-72A

 Musta pöördnupuga eksentriline klapp ja musta ülevoolukaitsega must ventiil

135.0683.055
Must matt

Hind €
425.-

 Manuaalventiil roostevast terasest klapikaanega

135.0683.027
Must matt

Hind €
415.-

135.0683.023
Onyx

399.-

135.0715.500
Slate Grey

399.-

135.0683.024
Kivihall

399.-

135.0683.026
Kašmiir

399.-

135.0683.025
Polaarvalge

399.-

Maris

Tasapinnaline



MARIS
01 02
03 04



Mõõdud: **553 x 433 mm**
Väljalõige: **vastavalt juhistele**
Kausi mõõtmed: **520 / 400 / 200 mm**
Paigaldamine: **tasapinnaline**
Materjal: **Fragraniit**
Ventiil: **koos ventiiliga 3½"**
Ventiili juhtimine: **manuaalne 3½"** ventiil
Ventiil kaas: **ümmargune**
Ülevool: **katteplaadiga ülevool**
Segisti auk: **ei**

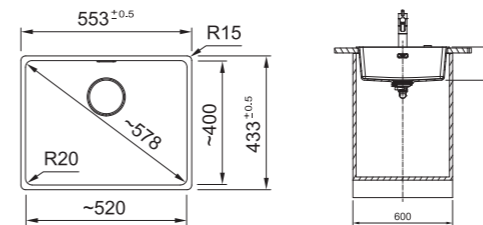

MRG 210-52

Musta pöördnupuga ekstsentriline klapp ja musta ülevoolukaitsega must ventiil

135.0683.051
Must matt

Hind €
389.-

MARIS
01 02
03 04



Mõõdud: **553 x 503 mm**
Väljalõige: **vastavalt juhistele**
Kausi mõõtmed: **520 / 400 / 200 mm**
Paigaldamine: **tasapinnaline**
Materjal: **Fragraniit**
Ventiil: **koos ventiiliga 3½"**
Ventiili juhtimine: **vajutusnupp või pöördnupp või käsitsi sõela avamine/sulgmine**
Ventiil kaas: **ümmargune**
Ülevool: **katteplaadiga ülevool**
Segisti auk: **ilma aukudeta**
(3 x 35 mm altpoolt puuritud augud)

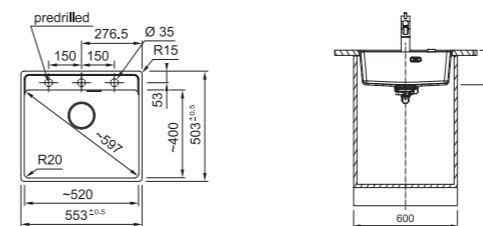

MRG 210-52A

Musta pöördnupuga ekstsentriline klapp ja musta ülevoolukaitsega must ventiil

135.0683.054
Must matt

Hind €
389.-

Käsitsi 3½" ventiil musta klapi, ülevoolude ja klapikaanega

135.0683.048
Must matt

Hind €
375.-

Manuaalventiil roostevabast terasest klapikaanega

135.0683.038
Must matt

Hind €
375.-

135.0683.034
Onyx

362.-

135.0715.508
Slate Grey

362.-

135.0683.035
Kivihall

362.-

135.0683.037
Kašmiir

362.-

135.0683.036
Polaarvalge

362.-

Valikulised lisad



01
112.0030.882
Rollmatt paindub
468 x 420 mm
86.- €

02
112.0188.651
Rv Mobiilne nõruti
plastik raamis
342 x 430 x 22 mm
120.- €

03
112.0473.656
Augufrees 35mm
Fragraniit ja
Tektoniit
valamutele
6.- €

04
ALL-IN
5 erinevat komplekti ALL IN
(rohkem lk 125) valamule:
340 x 540 mm
135.- ... 258.- €

Kokkusobivad tooted



115.0669.768
Active L Twist
Must matt
338.- €

Maris

Tasapinnaline



Valikulised lisad

- | | | | |
|--|--|---|---|
|
01 |
02 |
03 |
04 |
| 112.0030.882
Rullmatt paindub
468 x 420 mm
86.- € | 112.0188.651
Rv Mobiilne nõruti
plastik raamis
342 x 430 x 22 mm
120.- € | 112.0473.656
Augufrees 35mm
Fragraniit ja
Tektoniit
valamutele
6.- € | ALL-IN
5 erinevat komplekti ALL IN
(rohkem lk 125) valamule:
340 x 540 mm
135.- ... 258.- € |

Kokkusobivad



115.0669.768
 Active L Twist
 Must matt
338.- €

MARIS
 01 02
 03 04



Mõõdud: **403 x 433 mm**
 Väljalõige: **vastavalt juhistele**
 Kausi mõõtmed: **370 /400 /200 mm**
 Paigaldamine: **tasapinnaline**
 Materjal: **Fragraniit**
 Ventiiil: **koos ventiiliga 3½"**
 Ventiiili juhtimine: **pöördnupp või käsitsi sõela**
avamine/sulgmine
 Ventiiil kaas: **ümmargune**
 Ülevool: **katteplaadiga ülevool**
 Segisti auk: **ei**

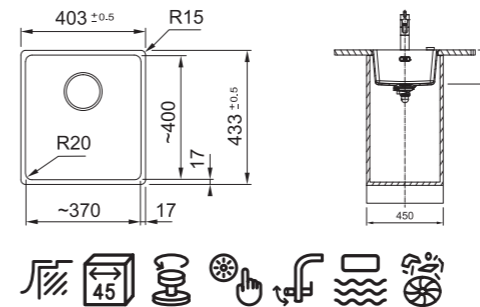

MARIS
 01 02
 03 04



Mõõdud: **403 x 503 mm**
 Väljalõige: **vastavalt juhistele**
 Kausi mõõtmed: **370 /400 /200 mm**
 Paigaldamine: **tasapinnaline**
 Materjal: **Fragraniit**
 Ventiiil: **koos ventiiliga 3½"**
 Ventiiili juhtimine: **ümmargune pöörlev**
 Ventiiil kaas: **ümmargune**
 Ülevool: **katteplaadiga ülevool**
 Segisti auk: **ilma aukudeta**
(3 x 35 mm altpoolt puuritud augud)

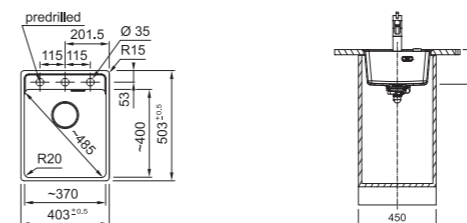

MRG 210-37

Musta pöördnupuga
ekstsentriline klapp ja
musta ülevoolukaitsega
must ventiiil
135.0683.050 Hind € **338.-**
 Must matt

Käsitsi 3½" ventiiil musta
klapi, ülevoolude ja
klapikaanega
135.0683.044 Hind € **330.-**
 Must matt

Manuaalventiil
roosteavabast terasest
klapikaanega
135.0682.986 Hind € **330.-**
 Must matt

135.0682.982 **316.-**
 Onyx

135.0715.504 **316.-**
 Slate Grey

135.0682.983 **316.-**
 Kivihall

135.0682.985 **316.-**
 Kašmiir

135.0682.984 **316.-**
 Polaarvalge

MRG 210-37A

Musta pöördnupuga
ekstsentriline klapp ja
musta ülevoolukaitsega
must ventiiil
135.0683.053 Hind € **338.-**
 Must matt

Kubus X

Altpoolt monteeritav Fraceram



Valikulised lisad

- | | | | |
|---|---|--|--|
|
01 |
02 |
03 |
04 |
| 112.0735.488
Puidust lõikelaud
240x416 mm
72.- € | 112.0188.653
Rv Mobiilne nõruti
plastik raamis
333 x 417 x 22 mm
80.- € | 112.0030.882
Rullmatt paindub
468 x 420 mm
86.- € | ALL-IN
5 erinevat komplekti
ALL IN
(rohkem lk 125) vala-
mule: 340 x 540 mm
135.- ... 258.- € |

Kokkusobivad tooted

- | | |
|---|--|
|
115.0711.554
Mythos Masterpiece
Roostevabast
terasest segisti
471.- € |
115.0521.438
Atlas Neo
Roostevabast
terasest segisti
324.- € |
|---|--|

MYTHOS

01 02
03 04

NEW



Mõõdud: **745 x 454 mm**
 Kausi mõõtmed: **705/400 /190 mm**
 Paigaldamine: **altpoolt monteeritav**
 Materjal: **Fraceram**
 Ventiiil: **manuaalne 3½" ventiil**
 Ülevool: **katteplaadiga ülevool**

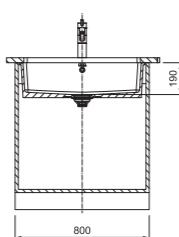
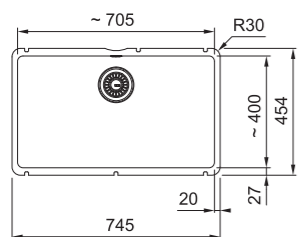

KXX 110-71

- | | |
|--|--------------|
|
Manuaalne ventiil | Hind € |
|
126.0735.195
Antratsiit matt | 869.- |
|
126.0735.194
Onyx, läikiv | 869.- |
|
126.0735.192
Polaarvalge, läikiv | 869.- |
|
126.0735.193
Magnolia, läikiv | 869.- |

MYTHOS

01 02
03 04

NEW



Mõõdud: **545 x 454 mm**
 Kausi mõõtmed: **370/400 /190 + 120/400/120 mm**
 Paigaldamine: **altpoolt monteeritav**
 Materjal: **Fraceram**
 Ventiiil: **manuaalne 3½" ventiil**
 Ülevool: **katteplaadiga ülevool**

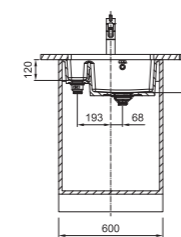
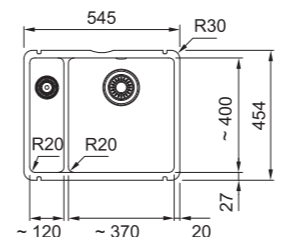

MYTHOS

01 02
03 04

NEW



Mõõdud: **545 x 454 mm**
 Kausi mõõtmed: **505/400 /190 mm**
 Paigaldamine: **altpoolt monteeritav**
 Materjal: **Fraceram**
 Ventiiil: **manuaalne 3½" ventiil**
 Ülevool: **katteplaadiga ülevool**

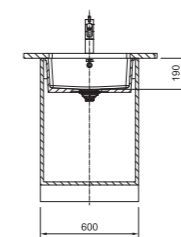
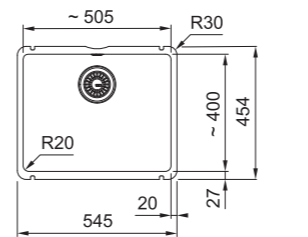

MYTHOS

01 02
03 04

NEW



Mõõdud: **445 x 454 mm**
 Kausi mõõtmed: **405/400 /190 mm**
 Paigaldamine: **altpoolt monteeritav**
 Materjal: **Fraceram**
 Ventiiil: **manuaalne 3½" ventiil**
 Ülevool: **katteplaadiga ülevool**

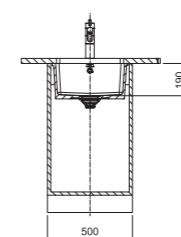
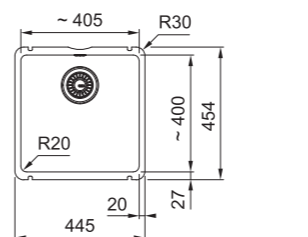

KXX 160-37-12

- | | |
|--|--------------|
|
Manuaalne ventiil | Hind € |
|
126.0735.191
Antratsiit matt | 638.- |
|
126.0735.190
Onyx, läikiv | 638.- |
|
126.0735.188
Polaarvalge, läikiv | 638.- |
|
126.0735.189
Magnolia, läikiv | 638.- |

KXX 110-51

- | | |
|--|--------------|
|
Manuaalne ventiil | Hind € |
|
126.0735.187
Antratsiit matt | 577.- |
|
126.0735.186
Onyx, läikiv | 577.- |
|
126.0735.183
Polaarvalge, läikiv | 577.- |
|
126.0735.185
Magnolia, läikiv | 577.- |

KXX 110-41

- | | |
|--|--------------|
|
Manuaalne ventiil | Hind € |
|
126.0735.182
Antratsiit matt | 510.- |
|
126.0735.181
Onyx, läikiv | 510.- |
|
126.0735.128
Polaarvalge, läikiv | 510.- |
|
126.0735.179
Magnolia, läikiv | 510.- |

ALL IN



Muudetava vahemaaga teleskoopraam sobib valamusse, mille diameeter on 340 kuni 540 mm.

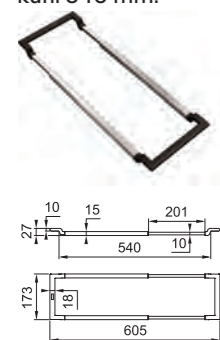

Bambusest lõikelaud.

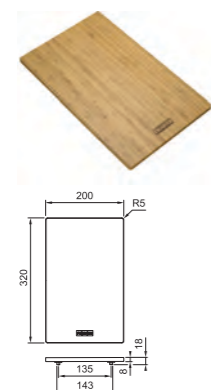

Suur pestav alus. Nõudepesumasinas pestav. Temperatuur < 100 °C.

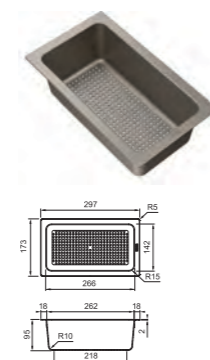

Väike loputusalus. Nõudepesumasinas pestav. Temperatuur < 100 °C.

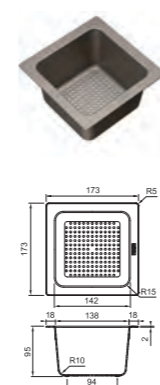

Toidu säilitusanum. Nõudepesumasinas pestav. Temperatuur < 100 °C.

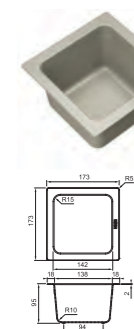

Säilitusanuma kaas on valmistatud bambusest.

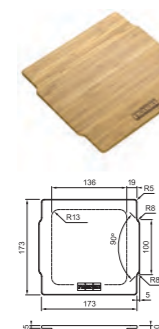

Laineline silikoonalus nõrgusa nõrutuspinnaga. Nõudepesumasinas pestav. Kuumi kuni temperatuuril 170 °C objekte võib sellele asetada ajuti.

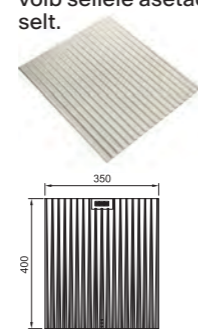

Säilituskarp kõigi All-In'i osade jaoks. Nõudepesumasinas pestav.



Komplekt Nr.1

112.0655.481

- Teleskoopraam
- Lõikelaud
- Suur loputusalus

135.- €

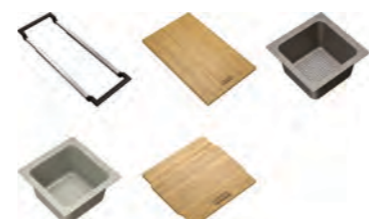

Komplekt Nr.2

112.0655.482

- Teleskoopraam
- Lõikelaud
- Väike loputusalus
- Väike kogumisanum
- Anuma kaas

147.- €

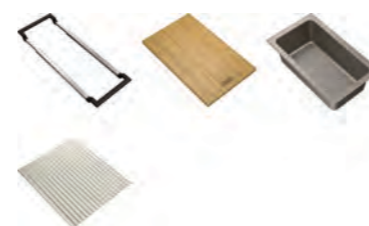

Komplekt Nr.3

112.0655.483

- Teleskoopraam
- Lõikelaud
- Suur loputusalus
- Kokkupandav matt

203.- €

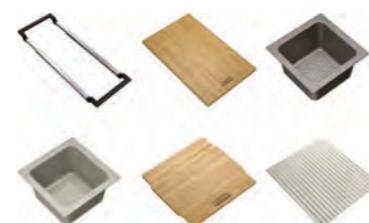

Komplekt Nr.4

112.0655.488

- Teleskoopraam
- Lõikelaud
- Väike loputusalus
- Väike kogumisanum
- Anuma kaas
- Kokkupandav matt

217.- €

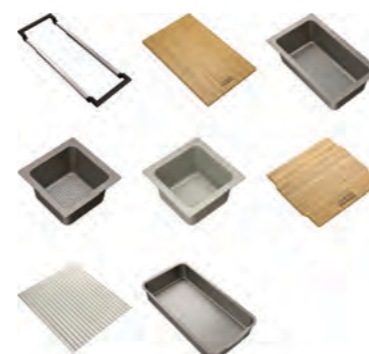

Komplekt Nr.5

112.0655.489

- Teleskoopraam
- Lõikelaud
- Suur loputusalus
- Väike loputusalus
- Väike kogumisanum
- Anuma kaas
- Kokkupandav matt
- Säilituskarp

258.- €



Segistid

Vital	131
Atlas Clear Water	133
Mythos Masterpiece	135
Pescara	137
Mythos	139
Active L Twist	141
Atlas Neo Sensor	143
Atlas	145
Eos Neo U	146
Eos Neo J	147
Smart Glenda	148
Smart Glenda J	149
Orbit	151
Maris Slim Semi-Pro	153
Maris Slim L	154
Maris Slim J	155
Icon Semi Pro	157
Active J	159
Active L	161
Urban	163
Orbit	164
Novara-Plus	165
Lina	166
Lina U	168
Lina L	169
Pola	171
Old England	172
Sirius	173
Seebidosatorid	174



Segistid

Filtreeritud vee segistid



Vital
131. lk.



Atlas Clear Water
133. lk.



Mythos Masterpiece
135. lk.



Pescara Semi Pro
137. lk.



Mythos
139. lk.



Atlas Neo Sensor
141. lk.



Atlas Neo
143. lk.



Atlas Neo Window
143. lk.



Eos Neo U
144. lk.



Eos Neo
145. lk.



Smart Glenda J
147. lk.



Smart Glenda
146. lk.



Orbit
149. lk.

Roostevabast terasest

Kroomitud ja värvilised segistid



Icon
151. lk.



Icon Semi Pro
151. lk.



Active Semi-Pro
164. lk.



Active L Twist
157. lk.



Active L
161. lk.



Active J
159. lk.



Urban
163. lk.



Maris Slim Semi-Pro
153. lk.



Maris Slim L
154. lk.



Maris Slim J
155. lk.



Lina Semi Pro
166. lk.



Lina XL
166. lk.



Lina
167. lk.



Lina U
168. lk.



Pola Semi Pro
171. lk.



Pola
171. lk.



Lina L
169. lk.



Sirius L
173. lk.



Old england
172. lk.



Novara Plus
165. lk.



Orbit
164. lk.

Seebidosaa- torid

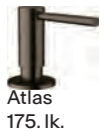

Atlas
175. lk.



Active Plus
175. lk.



Novita Steel
174. lk.



Comfort
175. lk.



Novita
174. lk.



MYTHOS



01 02

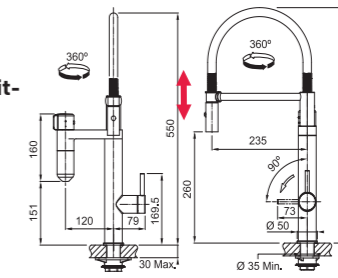

Kombineeritud filtreeritud ja kuuma/külma vee jaoks
 Vee väljavool: **väljatõmmatava dušiga / normaalse vooluga (lüliti-ga)**
 Aeraatori tüüp: **laminaarne vool**
 Pöördnurk: **360°**
 Materjal: **roostevaba teras**
 Segisti kang: **kang paremal**
 Filtra Segisti kang: **kang üleval**
 Veevool: **7,6 l/min (3 bar)**
 Filtreeritud vee vool: **3,5 l/min (3 bar)**
 Ühendustorud: **420 mm**
 Filtreeritava vee maht: **500L**



Vital Semi Pro
Väljatõmmatav otsak

- Hind €
-  **120.0621.230** **919.-**
 -  **120.0621.313** **1006.-**



MYTHOS



01 02

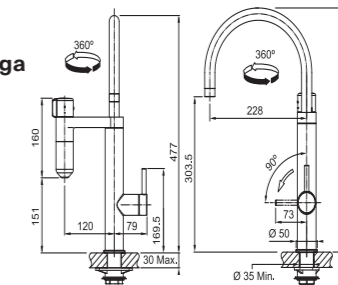

Kombineeritud filtreeritud ja kuuma/külma vee jaoks
 Vee väljavool: **fikseeritud otsikuga pööratava tilaga**
 Aeraatori tüüp: **laminaarne vool**
 Pöördnurk: **360°**
 Materjal: **roostevaba teras**
 Segisti kang: **kang paremal**
 Filtra Segisti kang: **kang üleval**
 Veevool: **12,5 l/min (3 bar)**
 Filtreeritud vee vool: **3,5 l/min (3 bar)**
 Ühendustorud: **420 mm**
 Filtreeritava vee maht: **500L**



Vital
Pööratav otsak

- Hind €
-  **120.0621.229** **659.-**
 -  **120.0621.312** **744.-**

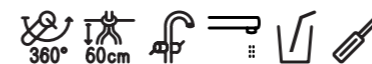

Valikulised lisad

01



112.0607.497
 Vital segisti filter
 500L
44.- €

02



112.0607.498
 Vital segisti filtrikomplekt
 (komplektis 3 filtrikapslit)
 500L x3
124.- €

Mythos Masterpiece



MYTHOS



Vee väljavool: **väljatõmmatava dušiga/ normaalse vooluga (lülitiga)**
 Aeraatori tüüp: **laminaarne vool**
 Pöördenurk: **360°**
 Materjal: **roostevaba teras**
 Segisti kang: **kang paremal**
 Ühendustorud: **550 mm**

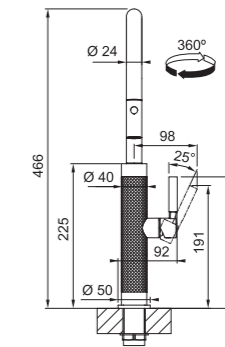
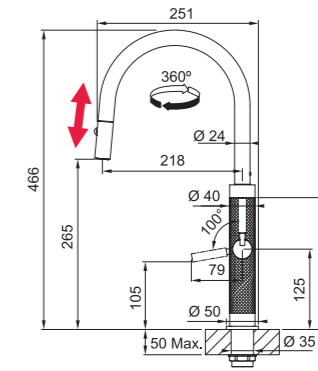

Mythos Masterpiece
 Väljatõmmatav otsak

	Hind €
115.0711.555 Antratsiit	586.-
115.0711.557 Vask	586.-
115.0711.558 Šampanjakuldne	586.-
115.0711.554 Roostevaba teras	471.-



Roostevaba teras



Antratsiit



Vask



Šampanjakuldne

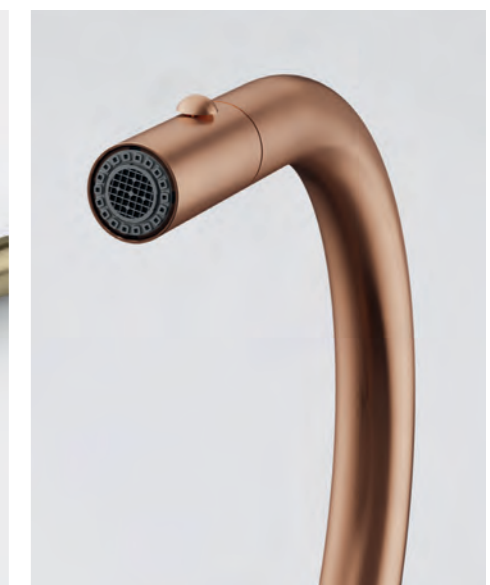
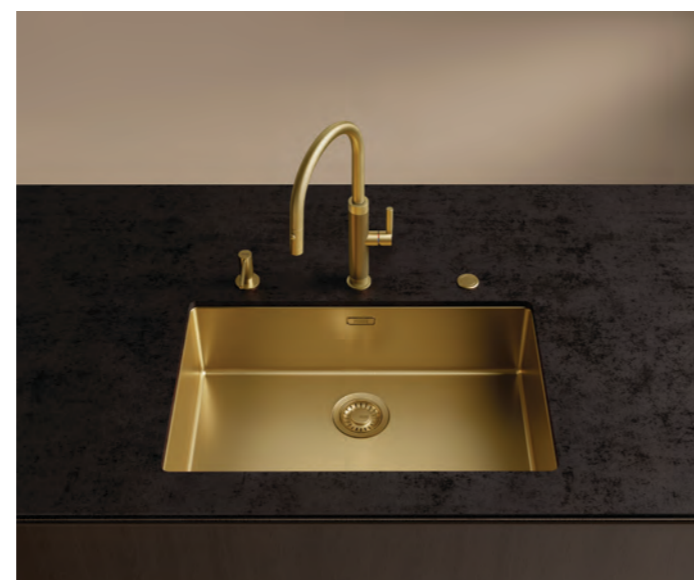
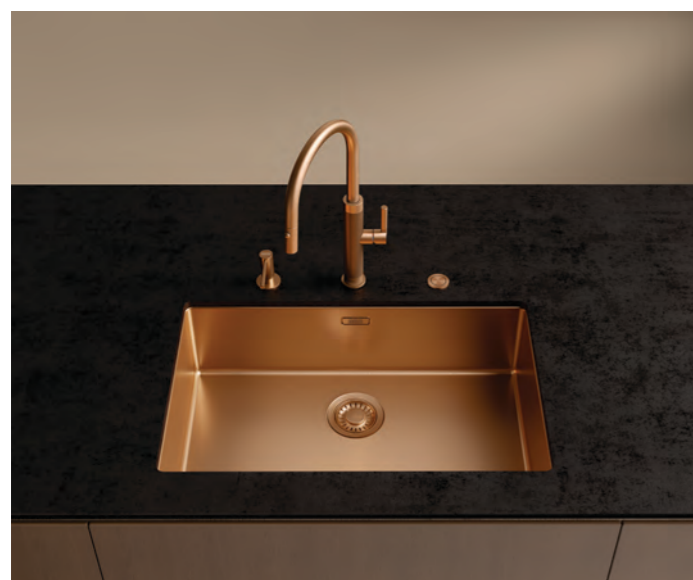



ATLAS NEO Kokkusobivad vedelseebi dosaatorid



112.0717.102
Atlas Neo Seebidosaatorid
Tööstuslik must
82.- €



112.0717.103
Atlas Neo Seebidosaatorid
Antratsiit
82.- €



112.0717.104
Atlas Neo Seebidosaatorid
Vask
82.- €



112.0717.105
Atlas Neo Seebidosaatorid
Šampanjakuldne
82.- €



112.0717.084
Atlas Neo Seebidosaatorid
Roostevaba teras
63.- €

MYTHOS





NEW

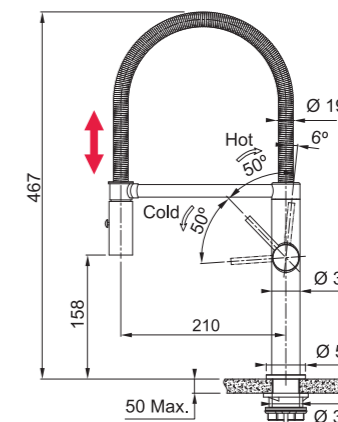

Vee väljavool: **väljatõmmatava dušiga/ normaalse vooluga (lülitiga)**
Aeraatori tüüp: **laminaarne vool**
Pöördenurk: **360°**
Materjal: **roostevaba teras**
Segisti kang: **kang paremal**
Veevool: **8 l/min (3 bar)**
Ühendustorud: **450 mm**



Pescara Semi Pro Väljatõmmatav otsak

	Hind €
 115.0741.721 Tööstuslik must	614.-
 115.0741.722 Antratsiit	614.-
 115.0741.724 Vask	614.-
 115.0741.723 Šampanjakuldne	614.-
 115.0741.700 Roostevaba teras	496.-





MYTHOS



Segisti mudel: **köögisegisti**
 Vee väljavool: **väljatõmmatava**
otsikuga
 Pöördenurk: **360°**
 Materjal: **roostevaba teras**
 Segisti kang: **kang paremal**
 Veevool: **9 l/min (3 bar)**
 Ühendustorud: **450 mm**
 Minimaalne kaugus segisti keskelt
 seinani 80 mm

Saadaval kuni juunini 2026

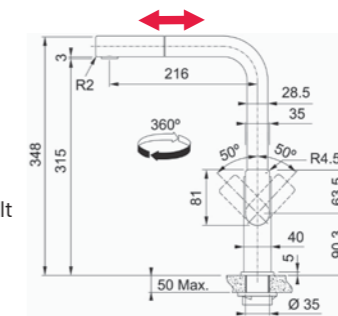

Mythos

Väljatõmmatav otsak

■ **115.0550.442**
Tööstuslik must

Hind €

485.-

■ **115.0547.853**
Roostevaba teras

437.-

MYTHOS



Segisti mudel: **köögisegisti**
 Vee väljavool: **fikseeritud otsikuga**
pööratava tilaga
 Aeraatori tüüp: **laminaarne vool**
 Pöördenurk: **360°**
 Materjal: **roostevaba teras**
 Segisti kang: **kang paremal**
 Veevool: **13 l/min (3 bar)**
 Ühendustorud: **450 mm**
 Minimaalne kaugus segisti keskelt
 seinani 80 mm

Saadaval kuni juunini 2026

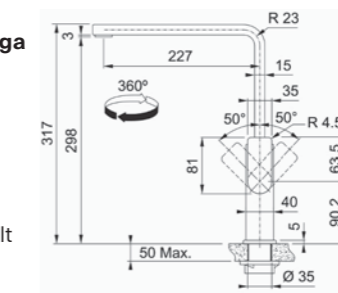

Mythos

Väljatõmmatav otsak

■ **115.0550.441**
Tööstuslik must

Hind €

397.-

■ **115.0547.852**
Roostevaba teras

360.-

ATLAS NEO Kokkusobivad vedelseebi dosaatorid



112.0717.102
Atlas Neo Seebidosaatid
Tööstuslik must
82.- €



112.0717.084
Atlas Neo Seebidosaatid
Roostevaba teras
63.- €

Atlas Neo Sensor



GERMAN
DESIGN
AWARD
SPECIAL
2022

MARIS



Segisti mudel: **Sensori ja käsitsi juhtimisega köögisegisti**
Vee väljavool: **väljatõmmatava otsikuga**
Aeraatori tüüp: **laminaarne vool**
Pöördenurk: **180°**
Materjal: **roostevaba teras**
Segisti kang: **kang paremal**
Veevool: **7 l/min (3 bar)**
Sensori veevool: **4 l/min (3 bar)**
Ühendustorud: **600 mm**

Komplektis: Juhtimiseseade koos 4 AA1,5 V patareiga (komplektis)

Anduri töö: Anduriga sisselülitamisel seiskub veevool automaatselt 30 sekundi pärast

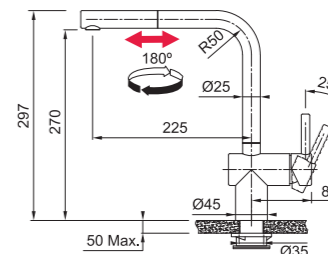

Atlas Neo Sensor
Väljatõmmatav otsak

115.0625.527
Tööstuslik must

Hind €
633.-

115.0625.523
Roostevaba teras

592.-

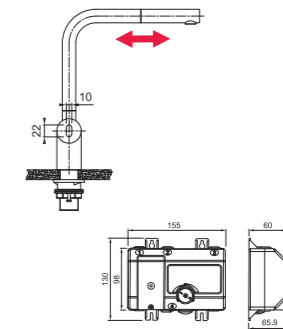

MARIS



Segisti mudel: **Sensori ja käsitsi juhtimisega köögisegisti**
Vee väljavool: **fikseeritud otsikuga pööratava tilaga**
Aeraatori tüüp: **laminaarne vool**
Pöördenurk: **180°**
Materjal: **roostevaba teras**
Segisti kang: **kang paremal**
Veevool: **7,5 l/min (3 bar)**
Sensori veevool: **4 l/min (3 bar)**
Ühendustorud: **450 mm**

Komplektis: Juhtimiseseade koos 4 AA1,5 V patareiga (komplektis)

Anduri töö: Anduriga sisselülitamisel seiskub veevool automaatselt 30 sekundi pärast

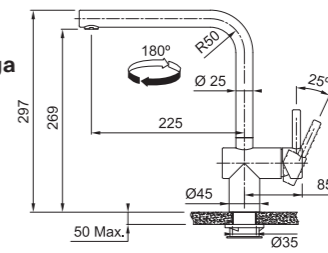
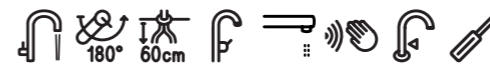

Atlas Neo Sensor
Fikseeritud, Pööratav ot-

115.0625.525
Tööstuslik must

Hind €
528.-

115.0625.489
Roostevaba teras

493.-

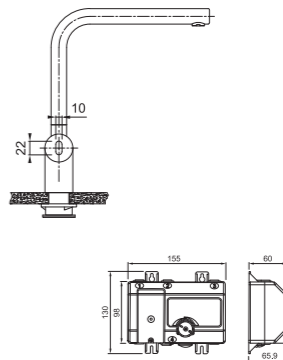

Roostevabast terasest veesegistid ATLAS NEO SENSOR anduri ja tavapärase juhtimisega

Mudelid on saadaval nii väljatõmmatava kui ka fikseeritud otsikuga. Roostevaba teras on kergesti hooldatav ja hügieeniliselt ohutu. Võib valida kriimustuskindla tööstuslikult musta kattega segisti.

M24 laminaarne aeraator vähendab pritsmeid ja muudab vee voolamise ühtlaseks.

Andurite abil juhtimine parandab köögihügieeni, kuna saame vett sageli kasutada ilma segistit füüsiliselt puudutamata.

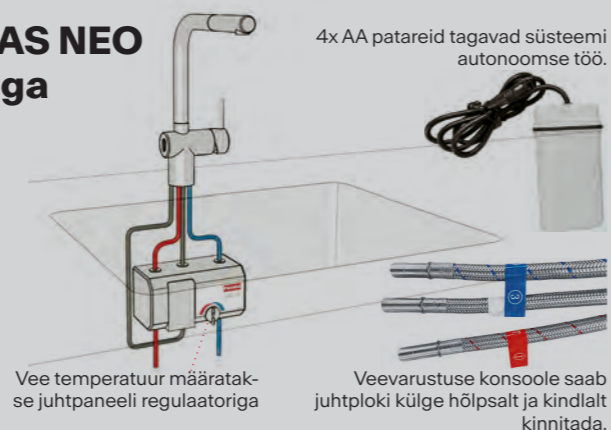

ANDURI JUHTIMINE



Liigutades oma käe 6 cm või lähemale vasakule küljele asuva anduri juurde ja vesi hakkab voolama 1 sekundi pärast. 30 sekundi pärast vool peatub. Vee temperatuur määratakse juhtnupu nupuga. Selle toiteallikaks on neli AA patareid, mis muudab süsteemi sõltumatuks. See säästab vett, kuna lülitame veevarustuse välja sageli hiljem kui vaja.

KANGIGA JUHTIMINE

Paremal küljel on kang, mille abil saab veevarustust tavapärasel viisil reguleerida. Keraamiline tööosa tagab pikaks ajaks ohutu töötamise.

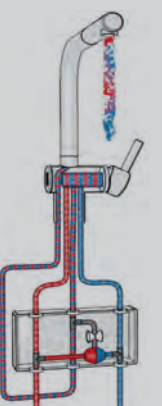

Atlas Neo



MARIS



Segisti mudel: **köögisegisti**
 Vee väljavool: **väljatõmmatava otsikuga**
 Aeraatori tüüp: **laminaarne vool**
 Pöördenurk: **180°**
 Materjal: **roostevaba teras**
 Segisti kang: **kang paremal**
 Veevool: **9,7 l/min (3 bar)**
 Ühendustorud: **450 mm**

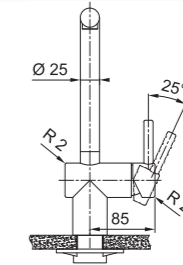
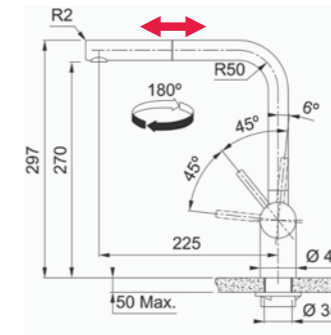

Atlas Neo
 Väljatõmmatav otsak

	Hind €
115.0550.427 Tööstuslik must	377.-
115.0628.210 Antratsiit	377.-
115.0628.208 Vask	377.-
115.0681.242 Šampanjakuldne	377.-
115.0521.438 Roostevaba teras	324.-

MARIS



Segisti mudel: **köögisegisti**
 Vee väljavool: **fikseeritud otsikuga**
 Aeraatori tüüp: **laminaarne vool**
 Pöördenurk: **180°**
 Materjal: **roostevaba teras**
 Segisti kang: **kang paremal**
 Veevool: **12,2 l/min (3 bar)**
 Ühendustorud: **450 mm**

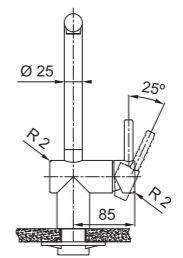
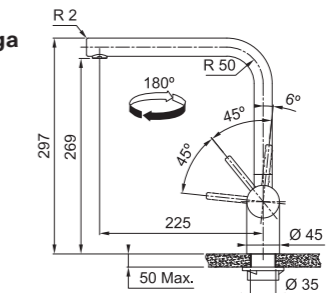

Atlas Neo
 Fikseeritud

	Hind €
115.0550.424 Tööstuslik must	324.-
115.0628.207 Antratsiit	324.-
115.0628.204 Vask	324.-
115.0681.241 Šampanjakuldne	324.-
115.0521.435 Roostevaba teras	270.-

MARIS

NEW



Segisti mudel: **köögisegisti**
 Vee väljavool: **väljatõmmatava dušiga/ normaalse vooluga (lülitiga)**
 Aeraatori tüüp: **laminaarne vool**
 Pöördenurk: **180°**
 Materjal: **roostevaba teras**
 Segisti kang: **kang paremal**
 Veevool: **7,6 l/min (3 bar)**
 Ühendustorud: **500 mm**

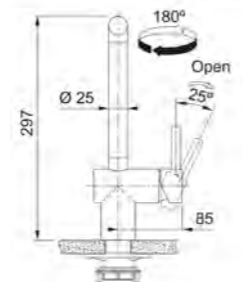
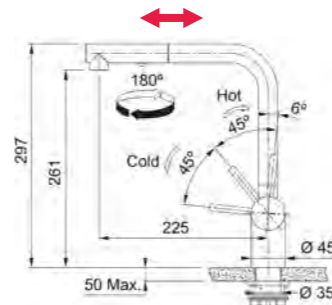

Atlas Neo
 Väljatõmmatav otsak

115.0741.710
 Roostevaba teras

Cena €
 338.-

MARIS



Segisti mudel: **Köögikatted on akna poolt kokkulapitavad**
 Vee väljavool: **väljatõmmatava otsikuga**
 Aeraatori tüüp: **laminaarne vool**
 Pöördenurk: **180°**
 Materjal: **roostevaba teras**
 Segisti kang: **kang paremal**
 Veevool: **8,2 l/min (3 bar)**
 Ühendustorud: **600 mm**

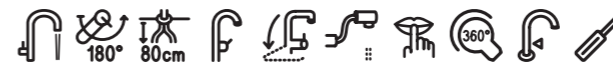
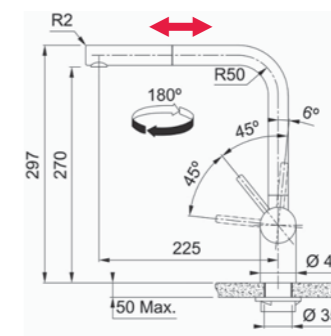

Atlas Neo Window
 Väljatõmmatav otsak

115.0521.439
 Roostevaba teras

Hind €
 352.-

ATLAS NEO Kokkusobivad vedelseebi dosaatorid



112.0717.102
 Atlas Neo Seebidosaatorid
 Tööstuslik must
 82.- €



112.0717.103
 Atlas Neo Seebidosaatorid
 Antratsiit
 82.- €



112.0717.104
 Atlas Neo Seebidosaatorid
 Vask
 82.- €



112.0717.105
 Atlas Neo Seebidosaatorid
 Šampanjakuldne
 82.- €



112.0717.084
 Atlas Neo Seebidosaatorid
 Roostevaba teras
 63.- €

Eos Neo U

MARIS



Segisti mudel: **köögisegisti**
 Vee väljavool: **väljatõmmatava otsikuga**
 Aeraatori tüüp: **laminaarne vool**
 Pöördnurk: **180°**
 Materjal: **roostevaba teras**
 Segisti kang: **kang paremal**
 Veevool: **8,25 l/min (3 bar)**
 Ühendustorud: **450 mm**

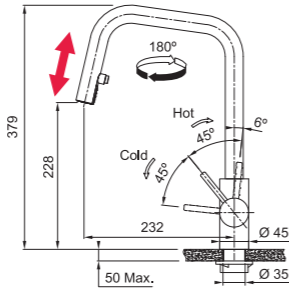

Eos Neo U
 Väljatõmmatav otsak

115.0529.207
 Roostevaba teras

Hind €
 342.-



MARIS



Segisti mudel: **köögisegisti**
 Vee väljavool: **fikseeritud otsikuga pööratava tilaga**
 Aeraatori tüüp: **laminaarne vool**
 Pöördnurk: **180°**
 Materjal: **roostevaba teras**
 Segisti kang: **kang paremal**
 Veevool: **11,2 l/min (3 bar)**
 Ühendustorud: **450 mm**

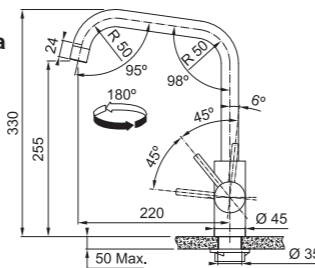

Eos Neo U
 Pööratav otsak

115.0529.202
 Roostevaba teras

Hind €
 282.-



ATLAS NEO Kokkusobivad vedelseebi dosaatorid



112.0717.102
 Atlas Neo Seebidosaatõid
 Tööstuslik must
 82.- €



112.0717.103
 Atlas Neo Seebidosaatõid
 Antratsiit
 82.- €



112.0717.104
 Atlas Neo Seebidosaatõid
 Vask
 82.- €



112.0717.105
 Atlas Neo Seebidosaatõid
 Šampanjakuldne
 82.- €



112.0717.084
 Atlas Neo Seebidosaatõid
 Roostevaba teras
 63.- €



Eos Neo J



MARIS



Segisti mudel: **köögisegisti**
 Vee väljavool: **väljatõmmatava dušiga/ normaalse vooluga (lülitiga)**
 Aeraatori tüüp: **laminaarne vool**
 Pöördnurk: **180°**
 Materjal: **roostevaba teras**
 Segisti kang: **kang paremal**
 Veevool: **9,2 l/min (3 bar)**
 Ühendustorud: **450 mm**

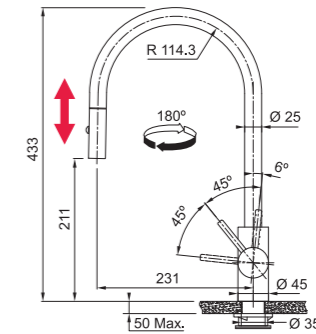

Eos Neo J
 Väljatõmmatav otsak

115.0613.671
 Tööstuslik must

Hind €

403.-

115.0628.256
 Antratsiit

403.-

115.0628.254
 Vask

403.-

115.0681.244
 Šampanjakuldne

403.-

115.0590.045
 Roostevaba teras

342.-



MARIS



Segisti mudel: **köögisegisti**
 Vee väljavool: **fikseeritud otsikuga pööratava tilaga**
 Aeraatori tüüp: **laminaarne vool**
 Pöördnurk: **180°**
 Materjal: **roostevaba teras**
 Segisti kang: **kang paremal**
 Veevool: **12 l/min (3 bar)**
 Ühendustorud: **450 mm**

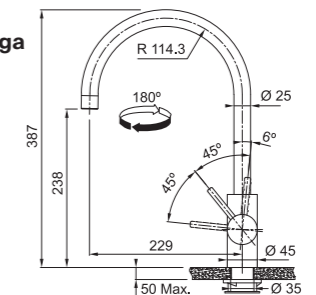

Eos Neo J
 Väljatõmmatav otsak

115.0613.590
 Tööstuslik must

Hind €

334.-

115.0628.253
 Antratsiit

334.-

115.0628.251
 Vask

334.-

115.0681.243
 Šampanjakuldne

334.-

115.0590.044
 Roostevaba teras

282.-



Smart Glenda



SMART



Vee väljavool: **väljatõmmatava otsikuga**
 Aeraatori tüüp: **laminaarne vool**
 Pöördenurk: **180°**
 Materjal: **roostevaba teras**
 Segisti kang: **kang paremal**
 Veevool: **9 l/min (3 bar)**
 Ühendustorud: **500 mm**

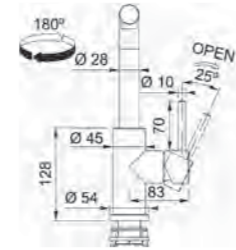
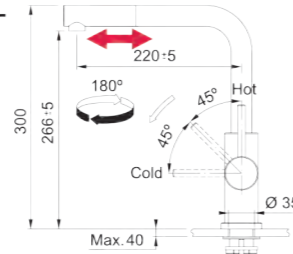

Smart Glenda
 Väljatõmmatav otsak

115.0706.986
 Roostevaba teras

Hind €
 209.-



SMART



Vee väljavool: **fikseeritud otsikuga pööratava tilaga**
 Aeraatori tüüp: **laminaarne vool**
 Pöördenurk: **180°**
 Materjal: **roostevaba teras**
 Segisti kang: **kang paremal**
 Veevool: **12,2 l/min (3 bar)**

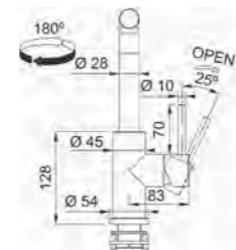
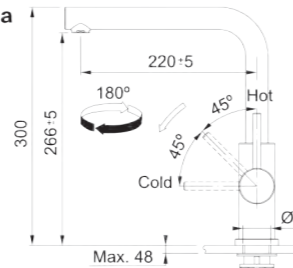

Smart Glenda
 Pööratav otsak

115.0706.985
 Roostevaba teras

Hind €
 173.-

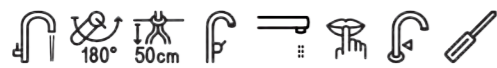

Smart Glenda J

SMART



Vee väljavool: **väljatõmmatava otsikuga**
 Aeraatori tüüp: **laminaarne vool**
 Pöördenurk: **180°**
 Materjal: **roostevaba teras**
 Segisti kang: **kang paremal**
 Veevool: **8.8 l/min (3 bar)**
 Ühendustorud: **500 mm**

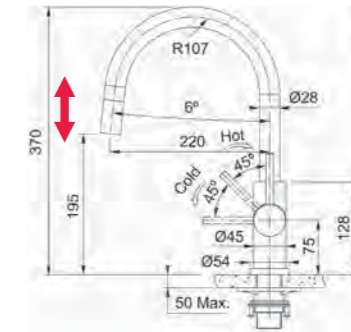

Smart Glenda J
 Väljatõmmatav otsak

115.0747.474
 Roostevaba teras

Hind €
 163.-



SMART



Vee väljavool: **fikseeritud otsikuga pööratava tilaga**
 Aeraatori tüüp: **laminaarne vool**
 Pöördenurk: **180°**
 Materjal: **roostevaba teras**
 Segisti kang: **kang paremal**
 Veevool: **10,6 l/min (3 bar)**

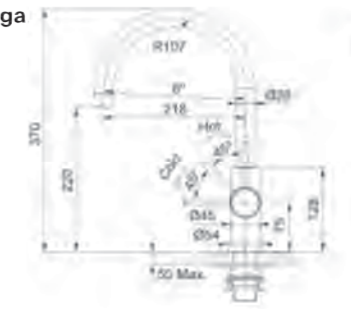

Smart Glenda J
 Pööratav otsak

115.0747.473
 Roostevaba teras

Hind €
 143.-

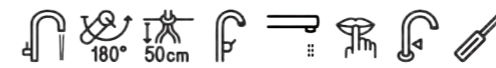



SMART



Vee väljavool: **väljatõmmatava otsikuga**
 Aeraatori tüüp: **laminaarne vool**
 Pöördenurk: **120°**
 Materjal: **roostevaba teras**
 Segisti kang: **kang üleval**
 Veevool: **8,5 l/min (3 bar)**
 Ühendustorud: **450 mm**

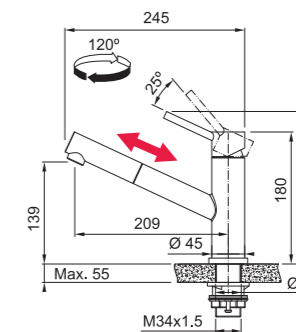

Orbit
 Väljatõmmatav otsak

115.0569.461
 Roostevaba teras

Hind €
177.-

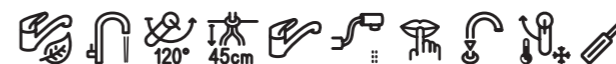

SMART



Vee väljavool: **fikseeritud otsikuga pööratava tilaga**
 Aeraatori tüüp: **laminaarne vool**
 Pöördenurk: **360°**
 Materjal: **roostevaba teras**
 Segisti kang: **kang üleval**
 Veevool: **15 l/min (3 bar)**
 Ühendustorud: **450 mm**

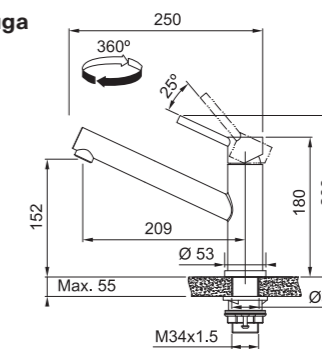

Orbit
 Pööratav otsak

115.0569.290
 Roostevaba teras

Hind €
149.-



Icon Semi Pro



MYTHOS



Segisti mudel: **köögisegisti**
 Vee väljavool: **väljatõmmatava dušiga/ normaalse vooluga (lülitiga)**
 Aeraatori tüüp: **laminaarne vool**
 Pöördenurk: **360°**
 Segisti kang: **kang paremal**
 Veevool: **7,7 l/min (3 bar)**

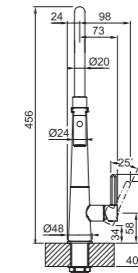
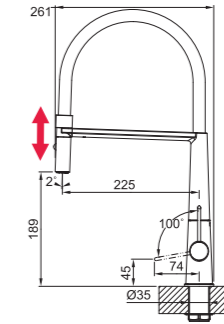

Icon Semi Pro
 Väljatõmmatav otsak

■ **115.0690.598**
 Must matt

Hind €
683.-

MYTHOS



Segisti mudel: **köögisegisti**
 Vee väljavool: **väljatõmmatava dušiga/ normaalse vooluga (lülitiga)**
 Aeraatori tüüp: **laminaarne vool**
 Pöördenurk: **360°**
 Segisti kang: **kang paremal**
 Veevool: **7,5 l/min (3 bar)**
 Ühendustorud: **450 mm**

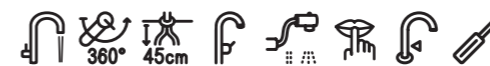
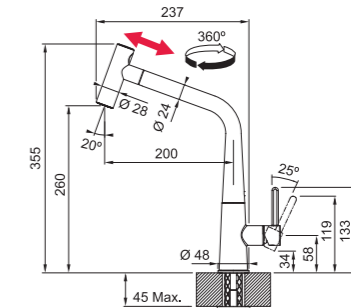

Icon
 Väljatõmmatav otsak

■ **115.0625.190**
 Must matt

■ **115.0625.188**
 Kroom

Hind €
606.-

479.-

Kokkusobivad vedelseebi dosaatorid



119.0547.906
 ACTIVE Seebidosaatid
 Must matt
117.- €



Maris Slim Semi-Pro



MARIS



NEW

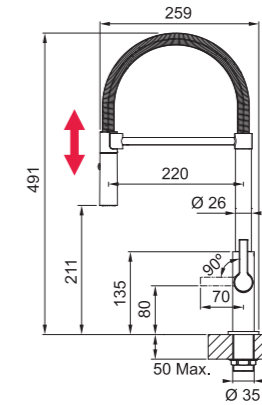

Vee väljavool: **väljatõmmatava dušiga/ normaalse vooluga (lülitiga)**
 Aeraatori tüüp: laminaarne vool
 Pöördenurk: **360°**
 Segisti kang: **kang paremal**
 Veevool: **8,4 l/min (3 bar)**
 Ühendustorud: **470 mm**



Maris Slim Semi-Pro
 Väljatõmmatav otsak

-  **115.0728.396**
Must matt
-  **115.0728.395**
Kroom

Hind €

350.-

318.-



Kokkusobivad vedelseebi dosaatorid



119.0547.906
 ACTIVE Seebidosaatid
 Must matt
 117.- €



119.0150.262
 Novita Seebidosaatid
 Kroom
 88.- €

Maris Slim L

MARIS

NEW



Vee väljavool: **väljatõmmatava otsikuga**
 Aeraatori tüüp: **laminaarne vool**
 Pöördenurk: **360°**
 Segisti kang: **kang paremal**
 Veevool: **8,3 l/min (3 bar)**
 Ühendustorud: **450 mm**

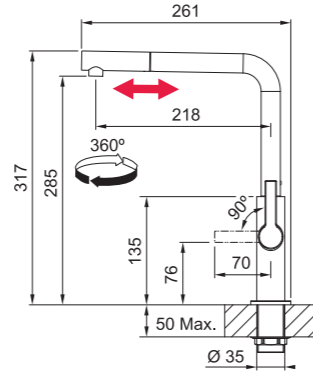

Maris Slim L
 Väljatõmmatav otsak

■ **115.0728.394**
 Must matt

Hind € **296.-**

■ **115.0728.393**
 Kroom

Hind € **241.-**



Maris Slim J

MARIS

NEW



Vee väljavool: **väljatõmmatava otsikuga**
 Aeraatori tüüp: **laminaarne vool**
 Pöördenurk: **360°**
 Segisti kang: **kang paremal**
 Veevool: **7,4 l/min (3 bar)**
 Ühendustorud: **470 mm**

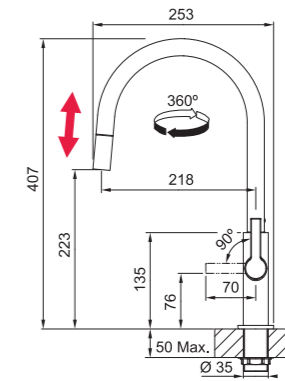

Maris Slim J
 Väljatõmmatav otsak

■ **115.0728.389**
 Must matt

Hind € **302.-**

■ **115.0728.388**
 Kroom

Hind € **248.-**



MARIS

NEW



Vee väljavool: **fikseeritud otsikuga pööratava tilaga**
 Aeraatori tüüp: **laminaarne vool**
 Pöördenurk: **360°**
 Segisti kang: **kang paremal**
 Veevool: **10,2 l/min (3 bar)**
 Ühendustorud: **450 mm**

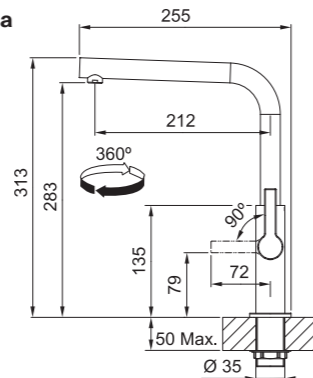

Maris Slim L
 Pööratav otsak

■ **115.0728.391**
 Must matt

Hind € **239.-**

■ **115.0728.390**
 Kroom

Hind € **191.-**



MARIS

NEW



Vee väljavool: **fikseeritud otsikuga pööratava tilaga**
 Aeraatori tüüp: **laminaarne vool**
 Pöördenurk: **360°**
 Segisti kang: **kang paremal**
 Veevool: **10,2 l/min (3 bar)**
 Ühendustorud: **450 mm**

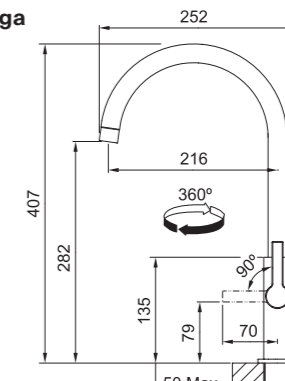

Maris Slim J
 Pööratav otsak

■ **115.0728.386**
 Must matt

Hind € **233.-**

■ **115.0728.384**
 Kroom

Hind € **187.-**



Kokkusobivad vedelseebi dosaatorid



119.0547.906
 ACTIVE Seebidosaatid
 Must matt
117.- €



119.0150.262
 Novita Seebidosaatid
 Kroom
88.- €

Active L Twist

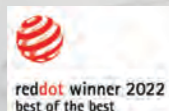

Franke Active Twist – lahendus kaasaegsesse kööki

See "kõik-ühes" segisti mitte ainult ei väljasta vett, vaid juhib ka selle äravoolu. Tänu integreeritud pöördnupule saab valamurühma tühjendada hügieeniliselt ja mugavalt, ilma tööpinda lisauke puurimata.

Hügieeniline: Valamu põhjaklapi juhtimine ühe pöördega.

Ökonoomne: Eco-kassett vähendab tarbimist kuni 50%.

Praktiline: Väljatõmmatav dušš ja vaikne, selge laminaarjuga.

Lihtne hooldada: Minimalistlik disain ilma üleliigsete detailideta.

MARIS



Vee väljavool: **väljatõmmatava otsikuga**
Pöördnurk: **180°**
Aeraatori tüüp: **laminaarne vool**
Segisti kang: **kang paremal**
Veevool: **7,5 l/min (3 bar)**
Ühendustorud: **450 mm**

Valamu põhjaklapi pöördnupp on integreeritud otse segistisse. Tänu sellele uuendusele ei ole enam vaja puurida tööpinda eraldi auku.

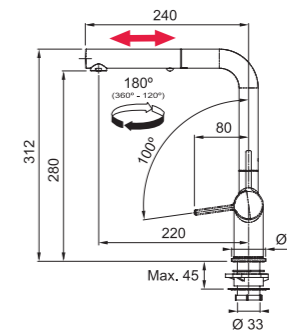

Active L Twist
Väljatõmmatav otsak

115.0669.769
Must matt

Hind €
417.-



MARIS



Vee väljavool: **fikseeritud otsikuga pööratava tilaga**
Aeraatori tüüp: **laminaarne vool**
Pöördnurk: **180°**
Segisti kang: **kang paremal**
Veevool: **8,3 l/min (3 bar)**
Ühendustorud: **450 mm**

Valamu põhjaklapi pöördnupp on integreeritud otse segistisse. Tänu sellele uuendusele ei ole enam vaja puurida tööpinda eraldi auku.

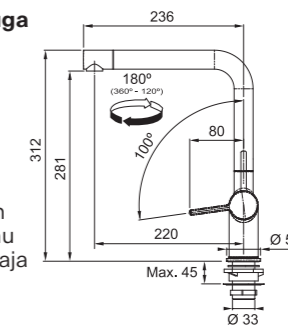

Active L Twist
Pööratav otsak

115.0669.768
Must matt

Hind €
338.-



Kokkusobivad vedelseebi dosaatorid



119.0547.906
ACTIVE Seebidosaatoreid
Must matt
117.- €



MARIS



Vee väljavool: **väljatõmmatava dušiga/ normaalse vooluga (lülitiga)**
 Aeraatori tüüp: **laminaarne vool**
 Pöördnurk: **180°**
 Segisti kang: **kang paremal**
 Veevool: **8,5 l/min (3 bar)**
 Ühendustorud: **450 mm**
 Silikoondušši katlakivi vastane toime

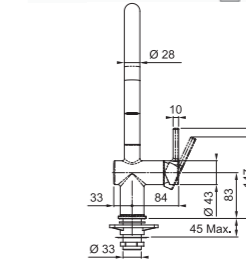
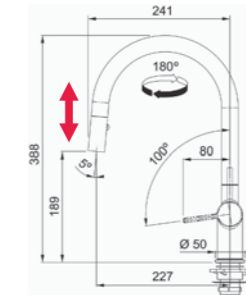

Active J Väljatõmmatav otsak

 **115.0653.404**
Must matt

Hind €
389.-

 **115.0653.401**
Kroom

350.-

MARIS



Segisti mudel: **kõigisegisti**
 Vee väljavool: **fikseeritud otsikuga pööratava tilaga**
 Aeraatori tüüp: **laminaarne vool**
 Pöördnurk: **180°**
 Segisti kang: **kang paremal**
 Veevool: **8,3 l/min (3 bar)**
 Ühendustorud: **450 mm**

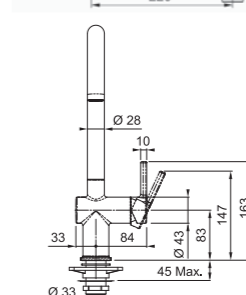
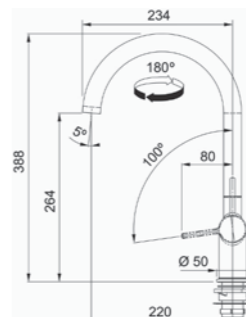

Active J Pööratav otsak

 **115.0653.398**
Must matt

Hind €
304.-

 **115.0653.395**
Kroom

280.-



MARIS



Vee väljavool: **väljatõmmatava otsikuga**
 Aeraatori tüüp: **laminaarne vool**
 Pöördenurk: **180°**
 Segisti kang: **kang paremal**
 Veevool: **7,5 l/min (3 bar)**
 Ühendustorud: **450 mm**

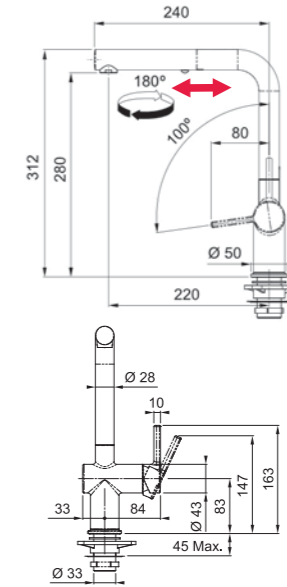

Active L

Väljatõmmatav otsak

	Hind €
115.0653.382 Must matt	364.-
115.0653.384 Onyx + Kroom	356.-
115.0721.464 Slate Grey + Kroom	356.-
115.0653.385 Kivihall + Kroom	356.-
115.0653.389 Kašmiir + Kroom	356.-
115.0653.387 Polaarvalge + Kroom	356.-
115.0653.379 Kroom	340.-

MARIS



Vee väljavool: **fikseeritud otsikuga pööratava tilaga**
 Aeraatori tüüp: **laminaarne vool**
 Pöördenurk: **360°**
 Segisti kang: **kang paremal**
 Veevool: **8,3 l/min (3 bar)**
 Ühendustorud: **450 mm**

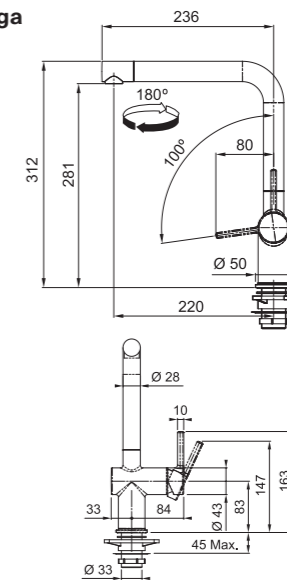

Active L

Pööratav otsak

	Hind €
115.0653.371 Must matt	296.-
115.0653.373 Onyx + Kroom	286.-
115.0721.463 Slate Grey + Kroom	286.-
115.0653.374 Kivihall + Kroom	286.-
115.0653.378 Kašmiir + Kroom	286.-
115.0653.376 Polaarvalge + Kroom	286.-
115.0653.298 Kroom	270.-

Urban



MARIS



Segisti mudel: **köögisegisti**
 Vee väljavool: **väljatõmmatava**
otsikuga
 Pöördnurk: **150°**
 Segisti kang: **kang paremal**
 Veevool: **10,2 l/min (3 bar)**
 Ühendustorud: **450 mm**

Saadaval kuni juunini 2026

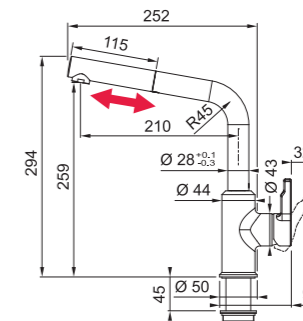

Urban
 Väljatõmmatav otsak

	Hind €
115.0627.523 Must matt	270.-
115.0595.091 Onyx	258.-
115.0595.089 Kivihall	258.-
115.0595.093 Kašmiir	258.-
115.0595.088 Polaarvalge	258.-
115.0595.083 Kroom	235.-

MARIS



Vee väljavool: **fikseeritud otsikuga**
pööratava tilaga
 Aeraatori tüüp: **laminaarne vool**
 Pöördnurk: **360°**
 Segisti kang: **kang paremal**
 Veevool: **14,9 l/min (3 bar)**
 Ühendustorud: **450 mm**

Saadaval kuni juunini 2026

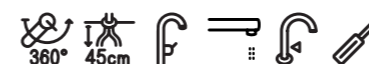
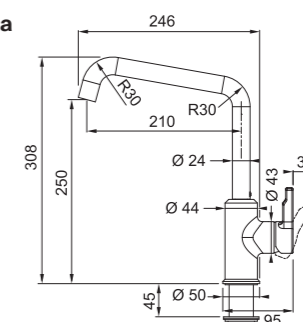

Urban
 Pööratav otsak

	Hind €
115.0627.524 Must matt	233.-
115.0595.081 Onyx	219.-
115.0595.069 Kivihall	219.-
115.0595.066 Kašmiir	219.-
115.0595.068 Polaarvalge	219.-
115.0595.062 Kroom	197.-





SMART



Vee väljavool: **väljatõmmatava otsikuga**
 Aeraatori tüüp: **laminaarne vool**
 Pöördenurk: **120°**
 Segisti kang: **kang üleval**
 Veevool: **9,9 l/min (3 bar)**
 Ühendustorud: **450 mm**

Tärniga (*) tähistatud mudelid on saadaval kuni juunini 2026

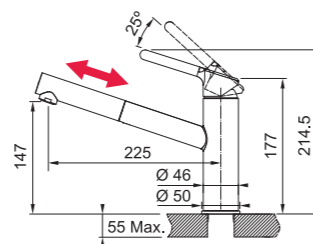

Orbit

Väljatõmmatav otsak

	Hind €
115.0659.965 Must matt	191.-
115.0623.057 * Onyx + Kroom *	177.-
115.0623.141 * Kivihall + Kroom *	177.-
115.0623.147 * Kašmiir + Kroom *	177.-
115.0623.139 * Polaarvalge + Kroom *	177.-
115.0623.055 Kroom	151.-



SMART



Vee väljavool: **väljatõmmatava dušiga/ normaalse vooluga (lülitiga)**
 Pöördenurk: **120°**
 Segisti kang: **kang üleval**
 Veevool: **10,3 l/min (3 bar)**
 Duširežiimid voolavad: **8,1 l/min (3 bar)**
 Ühendustorud: **450 mm**

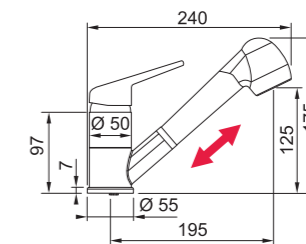

Novara-Plus

Väljatõmmatav otsak

	Hind €
115.0659.840 Must matt	155.-
115.0470.675 Onyx	143.-
115.0470.670 Kivihall	143.-
115.0470.666 Kašmiir	143.-
115.0470.665 Beež	143.-
115.0470.669 Polaarvalge	143.-
115.0347.111 Kroom	116.-



SMART



Vee väljavool: **fikseeritud otsikuga pööratava tilaga**
 Aeraatori tüüp: **laminaarne vool**
 Pöördenurk: **360°**
 Segisti kang: **kang üleval**
 Veevool: **11,9 l/min (3 bar)**
 Ühendustorud: **450 mm**

Tärniga (*) tähistatud mudelid on saadaval kuni juunini 2026

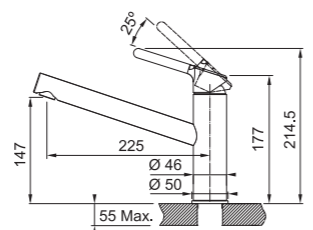

Orbit

Pööratav otsak

	Hind €
115.0659.964 Must matt	165.-
115.0623.056 * Onyx + Kroom *	149.-
115.0623.140 * Kivihall + Kroom *	149.-
115.0623.146 * Kašmiir + Kroom *	149.-
115.0623.137 * Polaarvalge + Kroom *	149.-
115.0623.054 Kroom	127.-



SMART



Vee väljavool: **fikseeritud otsikuga pööratava tilaga**
 Pöördenurk: **360°**
 Segisti kang: **kang üleval**
 Veevool: **16,3 l/min (3 bar)**
 Ühendustorud: **450 mm**

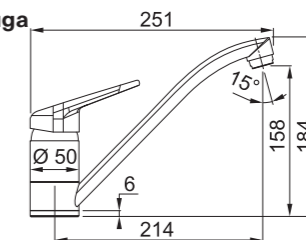

Novara-Plus

Pööratav otsak

	Hind €
115.0470.661 Onyx	106.-
115.0470.659 Kivihall	106.-
115.0470.655 Kašmiir	106.-
115.0470.654 Beež	106.-
115.0470.658 Polaarvalge	106.-
115.0347.142 Kroom	78.-

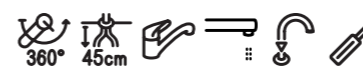



SMART



Vee väljavool: **väljatõmmatava dušiga/ normaalse vooluga (lülitiga)**
 Pöördnurk: **360°**
 Segisti kang: **kang paremal**
 Veevool: **7,65 l/min (3 bar)**
 Ühendustorud: **450 mm**

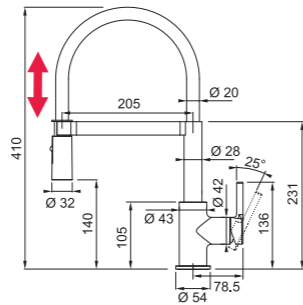

Lina Semi Pro
 Väljatõmmatav otsak

115.0626.085
 Kroom/ must

Hind €
159.-

SMART



Vee väljavool: **väljatõmmatava dušiga/ normaalse vooluga (lülitiga)**
 Pöördnurk: **360°**
 Segisti kang: **kang paremal**
 Veevool: **9 l/min (3 bar)**
 Ühendustorud: **450 mm**

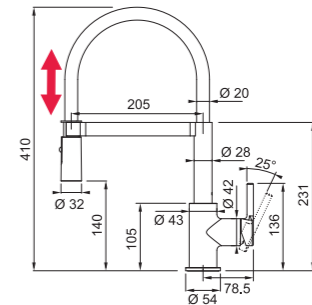

Lina Semi Pro Black
 Väljatõmmatav otsak

115.0725.838
 Must matt

Hind €
171.-



SMART



Vee väljavool: **fikseeritud otsikuga pööratava tilaga**
 Pöördnurk: **360°**
 Segisti kang: **kang paremal**
 Veevool: **14 l/min (3 bar)**
 Ühendustorud: **450 mm**

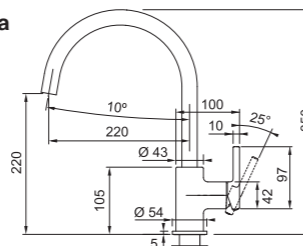

Lina XL
 Pööratav otsak

- 115.0626.019** 135.-
Must matt
- 115.0626.020** 124.-
Onyx
- 115.0626.022** 124.-
Kivihall
- 115.0626.028** 124.-
Kašmiir
- 115.0626.026** 124.-
Beež
- 115.0626.024** 124.-
Polaarvalge
- 115.0693.228** 112.-
Kroom

SMART



Segisti mudel: **köögisegisti**
 Vee väljavool: **väljatõmmatava otsikuga**
 Pöördnurk: **150°**
 Segisti kang: **kang paremal**
 Veevool: **8,2 l/min (3 bar)**
 Ühendustorud: **420 mm**

Hromëtai versijai:
 Pöördnurk: **360°**

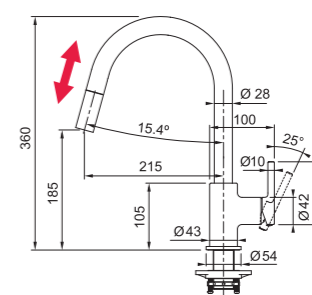

Lina J
 Väljatõmmatav otsak

- 115.0626.053** 147.-
Must matt
- 115.0626.055** 135.-
Onyx
- 115.0626.057** 135.-
Kivihall
- 115.0626.084** 135.-
Kašmiir
- 115.0626.083** 135.-
Beež
- 115.0626.081** 135.-
Polaarvalge
- 115.0693.229** 125.-
Kroom

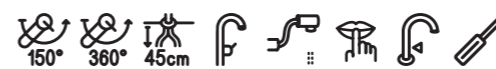
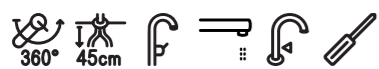

Lina U



Lina L



SMART



Vee väljavool: **väljatõmmatava otsikuga**
 Aeraatori tüüp: **kärgstruktuuriga**
 Pöördnurk: **360°**
 Segisti kang: **kang paremal**
 Veevool: **8,5 l/min (3 bar)**
 Ühendustorud: **470 mm**

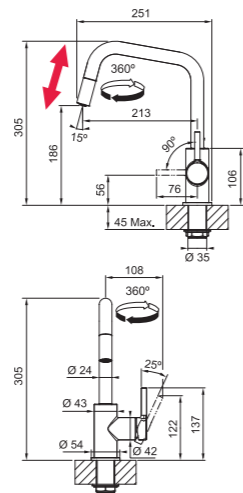

Lina U

Väljatõmmatav otsak

■ **115.0728.477**
Must matt

■ **115.0728.476**
Kroom

Hind €

211.-

185.-



SMART



Vee väljavool: **väljatõmmatava otsikuga**
 Aeraatori tüüp: **kärgstruktuuriga**
 Pöördnurk: **360°**
 Segisti kang: **kang paremal**
 Veevool: **7,2 l/min (3 bar)**
 Ühendustorud: **450 mm**

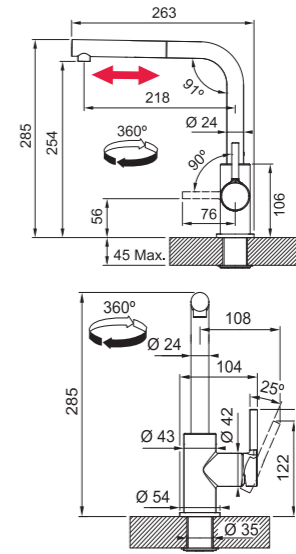

Lina L

Väljatõmmatav otsak

■ **115.0712.435**
Must matt

■ **115.0728.484**
Onyx

■ **115.0728.486**
Kivihall

■ **115.0728.489**
Beež

■ **115.0728.485**
Polaarvalge

■ **115.0712.420**
Kroom

Hind €

159.-

153.-

153.-

153.-

153.-

147.-



SMART



Vee väljavool: **fikseeritud otsikuga pööratava tilaga**
 Pöördnurk: **360°**
 Segisti kang: **kang paremal**
 Veevool: **10,45 l/min (3 bar)**
 Ühendustorud: **470 mm**

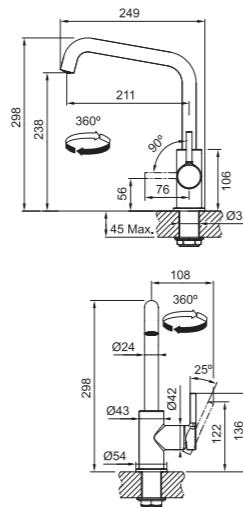

Lina U

Pööratav otsak

■ **115.0728.474**
Must matt

■ **115.0728.473**
Kroom

Hind €

169.-

145.-



SMART



Vee väljavool: **fikseeritud otsikuga pööratava tilaga**
 Pöördnurk: **360°**
 Segisti kang: **kang paremal**
 Veevool: **9,8 l/min (3 bar)**
 Ühendustorud: **450 mm**

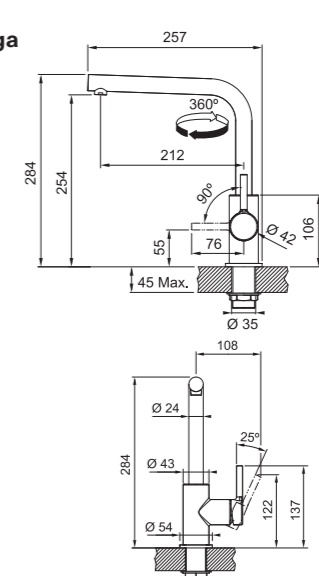

Lina L

Pööratav otsak

■ **115.0693.393**
Must matt

■ **115.0728.478**
Onyx

■ **115.0728.480**
Kivihall

■ **115.0728.483**
Beež

■ **115.0728.479**
Polaarvalge

■ **115.0693.230**
Kroom

Hind €

149.-

143.-

143.-

143.-

143.-

133.-

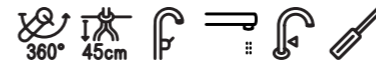

Pola Semi Pro & Pola



Kokkusobivad vedelseebi dosaatorid



119.0547.906
ACTIVE Seebidosaatid
Must matt
114.- €



119.0150.262
Novita Seebidosaatid
Kroom
85.- €

SMART

NEW

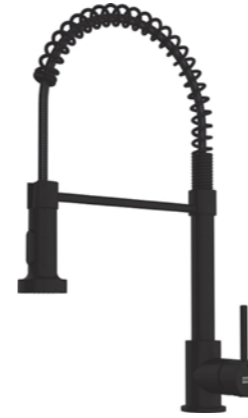

Vee väljavool: **väljatõmmatava dušiga/ normaalse vooluga (lülitiga)**
Pöördenurk: **360°**
Segisti kang: **kang paremal**

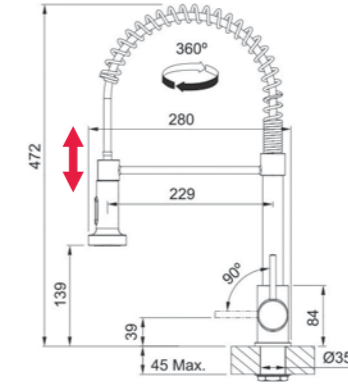

Pola Semi Pro

Väljatõmmatav otsak

	Hind €
115.0735.629 Must matt	155.-
115.0735.628 Kroom	143.-



SMART

NEW



Vee väljavool: **väljatõmmatava otsikuga**
Pöördenurk: **360°**
Segisti kang: **kang paremal**

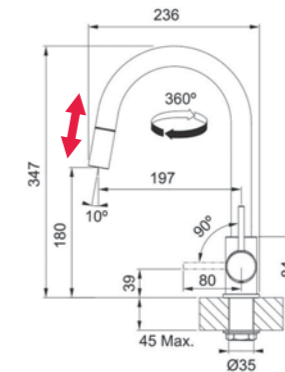

Pola

Väljatõmmatav otsak

	Hind €
115.0735.625 Must matt	127.-
115.0735.626 Onyx	122.-
115.0735.624 Kroom	110.-



SMART

NEW



Vee väljavool: **fikseeritud otsikuga pööratava tilaga**
Pöördenurk: **360°**
Segisti kang: **kang paremal**

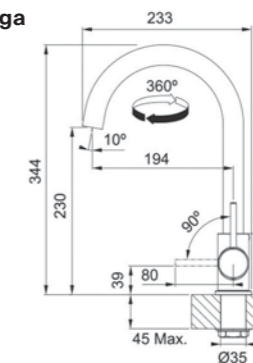

Pola

Pööratav otsak

	Hind €
115.0735.621 Must matt	100.-
115.0735.622 Onyx	94.-
115.0735.610 Kroom	82.-





SMART



Vee väljavool: **fikseeritud otsikuga pööratava tilaga**
Pöördnurk: **360°**
Segisti kang: **kang paremal**
Veevool: **12 l/min (3 bar)**
Ühendustorud: **450 mm**
Aluse läbimõõt: **56 mm**

Minimaalne kaugus segisti keskelt seinani 45 mm

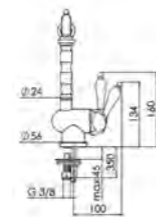
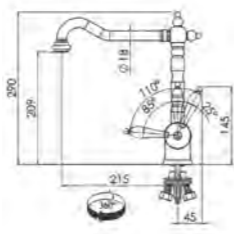

Old England

Pööratav otsak

Hind €

 **115.0028.205** 209.-
Pronks

 **115.0028.208** 209.-
Vask

 **115.0060.360** 199.-
Kroom



SMART



Segisti mudel: **köögisegisti**
Vee väljavool: **väljatõmmatava otsikuga**
Pöördnurk: **360°**
Segisti kang: **külgedel mõlemal küljel**
Veevool: **9,6 l/min (3 bar)**
Ühendustorud: **400 mm**
Minimaalne kaugus segisti keskelt seinani 80 mm

Saadaval kuni aprillini 2026

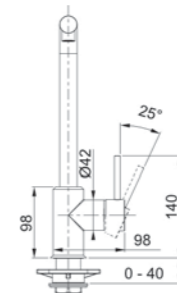
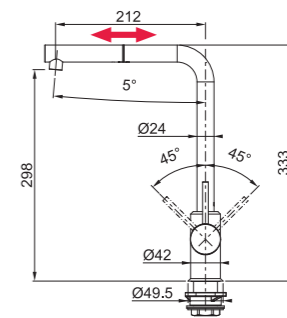

Sirius

Pööratav otsak

Hind €

 **115.0668.279** 137.-
Onyx + Kroom

 **115.0668.280** 127.-
Kroom



Seebidosaatid



Active Plus

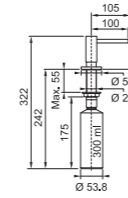

Tüüp: **Seebidosaatid**
Paigaldamine: **Valamule või tööpinnale**
Täitke ülalt
Maht: **300 ml**
Tööpinna paigaldusaugud: **25 või 35 mm**

	Hind €
119.0547.906 Must matt	117.-
112.0726.571 Slate Grey	117.-
119.0547.905 Polaarvalge matt	117.-
119.0547.902 Kroom	105.-

Comfort

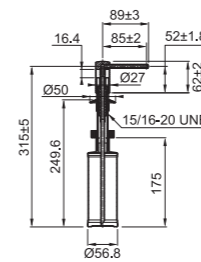

Tüüp: **Seebidosaatid**
Paigaldamine: **Valamule või tööpinnale**
Täitke ülalt
Maht: **250 ml**
Tööpinna paigaldusaugud: **25 või 35 mm**

119.0578.743 Onyx / Kroom	50.-
119.0578.744 Kivihall / Kroom	50.-
119.0578.750 Kašmiir / Kroom	50.-
119.0578.745 BeeZ / Kroom	50.-
119.0578.748 Polaarvalge / Kroom	50.-
119.0578.771 Roostevaba värv	50.-
119.0584.065 Kroom	50.-

Novita Steel

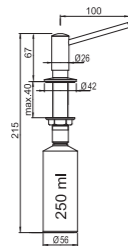

Tüüp: **Seebidosaatid**
Paigaldamine: **Valamule või tööpinnale**
Täitke ülalt
Maht: **250 ml**
Tööpinna paigaldusaugud: **19, 25 või 35 mm**

	Hind €
119.0177.893 Roostevaba teras	211.-

Novita

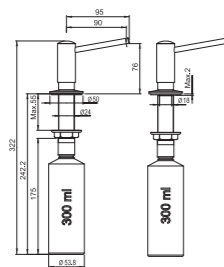

Tüüp: **Seebidosaatid**
Paigaldamine: **Valamule või tööpinnale**
Täitke ülalt
Maht: **300 ml**
Tööpinna paigaldusaugud: **19, 25 või 35 mm**

119.0155.993 Roostevaba värv	110.-
119.0150.262 Kroom	88.-

Atlas

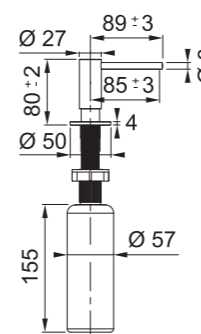

Tüüp: **Seebidosaatid**
Paigaldamine: **Valamule või tööpinnale**
Täitke ülalt
Maht: **350 ml**
Tööpinna paigaldusaugud: **25 või 35 mm**

112.0717.102 Tööstuslik must	82.-
112.0717.103 Antratsiit	82.-
112.0717.104 Vask	82.-
112.0717.105 Šampanjakuldne	82.-
112.0717.084 Roostevaba teras	63.-



Sorterid



FX	178
Garbo 60	179
Garbo 50	180
Cube 50	180
Garbo 45	181
Easy Sort 45	181
Cube 40	182
Sorter Pivot	182
Sorter Mini	182
Cube 30	183
Lisad	183
Elite Slim Jäätmepurustajad	185



60 cm



MYTHOS



FX
Aluskapp: 60 cm
Mõõdud: 600 x 506 x 448 mm
Sorteri tüüp: **esiuksega avatav**
Paigaldamine: **kinnitatakse külgseinte külge lihtne paigaldada, šabloon kaasas**

Erimärkused:
- sissehitatud aktiivsöefilter
- plastikust sahtel mahutite kaanena
- plastist raam prügikottide kinnitamiseks
- ukse reguleerimine küljelt

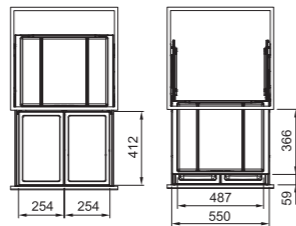

FX
Maht 2x 26L
Hind € 268.-
121.0557.764
Maht 2x 26L

26 l	26 l
------	------

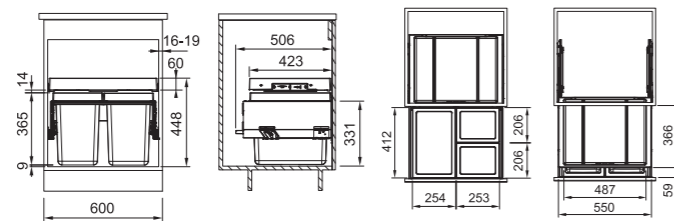

FX
Maht 26L + 2x 11L
Hind € 268.-
121.0557.763
Maht 26L + 2x 11L

26 l	11 l
	11 l



MARIS

01 03
05 07



Garbo 60-4
Aluskapp: 60 cm
Mõõdud: 562 x 399 x 360 mm
Sorteri tüüp: **esiuksega avatav**
Paigaldamine: **kinnitatakse külgseinte külge**

Erimärkused:
- metallist riul mahutite kaanena
- ukse reguleerimine küljelt
- sujuv sulgumine
- täielikult väljatulev, kandejõud 45 kg

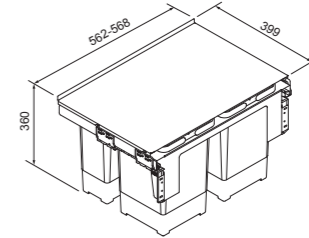

Garbo 60-4
Maht 2x 12L + 2x 8L

121.0200.676
Maht 2x 12L + 2x 8L

Hind € 191.-

8 l	8 l
12 l	12 l



MARIS

01 07
04 08
06 09
05 10
05 11



Garbo 60-3
Aluskapp: 60 cm
Mõõdud: 562 x 399 x 360 mm
Sorteri tüüp: **esiuksega avatav**
Paigaldamine: **kinnitatakse külgseinte külge**

Erimärkused:
- metallist riul mahutite kaanena
- ukse reguleerimine küljelt
- sujuv sulgumine
- täielikult väljatulev, kandejõud 45 kg
- mahuti kasutatud patareidele

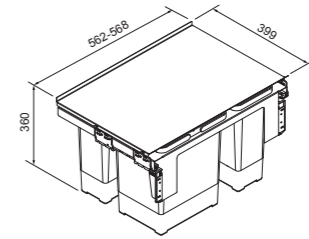

Garbo 60-3
Maht 18L + 12L + 8L

121.0200.680
Maht 18L + 12L + 8L

Hind € 191.-

12 l	
18 l	8 l



MARIS

04 09
10



Garbo 60-2
Aluskapp: 60 cm
Mõõdud: 562 x 399 x 360 mm
Sorteri tüüp: **esiuksega avatav**
Paigaldamine: **kinnitatakse külgseinte külge**

Erimärkused:
- metallist riul mahutite kaanena
- ukse reguleerimine küljelt
- sujuv sulgumine
- täielikult väljatulev, kandejõud 45 kg

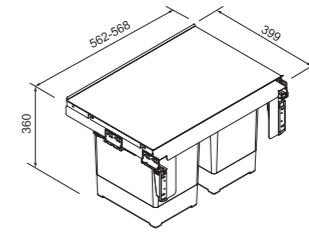

Garbo 60-2
Maht 2x 18L

121.0284.027
Maht 2x 18L

Hind € 191.-

18 l	18 l
------	------



SMART



EASY SORT 60
Aluskapp: 60 cm
Mõõdud: 564 x 378 x 343 mm
Sorteri tüüp: **sahtlisse paigaldatav**
Paigaldamine: **kasutab köögikapi sahtlit**

Erimärkused:
- toodetud taaskasutatud plastist
- eriti tugev käepide (kuni 18 kg)
- antiseptiline materjal takistab 99% bakterite paljunemist
- libisemisvastased padjad

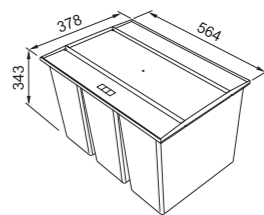

EASY SORT 60

Maht 3x 14,5L
121.0494.192
Maht 3x 14,5L

Hind € 50.-

Maht 2x 14,5L + 2x 7,5L
121.0494.193
Maht 2x 14,5L + 2x 7,5L

Hind € 55.-

50 cm



45 cm



MARIS

01 02
03 05
06 07
08



Garbo 50-3
Aluskapp: **50 cm**
Mõõdud: **462 x 399 x 360 mm**
Sorteri tüüp: **esiuksega avatav**
Paigaldamine: **kinnitatakse külgliseinte külge**

Erimärkused:
- metallist riiul mahutite kaanena
- ukse reguleerimine küljelt
- sujuv sulgumine
- täielikult väljatulev,
kandejõud 45 kg

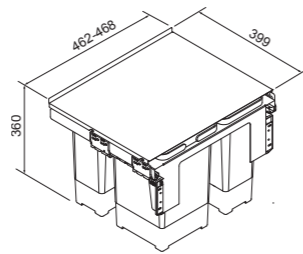

Garbo 50-3

Maht **2x 26L** Hind €
121.0200.691 **183.-**
Maht **2x 12L + 8L**

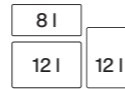

MARIS

02 04
06 08
09 10



Garbo 45-2
Aluskapp: **45 cm**
Mõõdud: **412 x 399 x 360 mm**
Sorteri tüüp: **esiuksega avatav**
Paigaldamine: **kinnitatakse külgliseinte külge**

Erimärkused:
- metallist riiul mahutite kaanena
- ukse reguleerimine küljelt
- sujuv sulgumine
- täielikult väljatulev,
kandejõud 45 kg

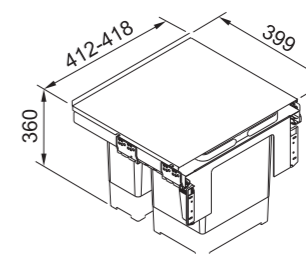

Garbo 45-2

Maht **18L + 12L** Hind €
121.0200.692 **177.-**
Maht **18L + 12L**



MARIS

15 16
17 19
20 21
22 23



Cube 50
Aluskapp: **50 cm**
Mõõdud: **470 x 330 x 345 mm**
Sorteri tüüp: **küljele avaneva uksega avanev**
Paigaldamine: **kapi põhjale kinnitav**

Erimärkused:
-Vajalik 110° avanevad uksehinged

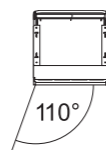
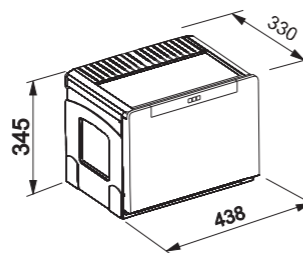

Cube 50

Maht **18L + 14L** Hind €
134.0055.292 **101.-**
Maht **18L + 14L**



SMART



EASY SORT 45
Aluskapp: **45 cm**
Mõõdud: **414 x 378 x 343 mm**
Sorteri tüüp: **sahtlisse paigaldatav**
Paigaldamine: **kasutab köögikapi sahtlit**

Erimärkused:
- toodetud taaskasutatud plastist
- eriti tugev käepide (kuni 18 kg)
- antiseptiline materjal takistab 99% bakterite paljunemist
- libisemisvastased padjad

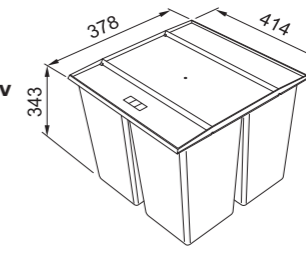

EASY SORT 45

Maht **2x 14,5L** Hind €
121.0494.182 **37.-**
Maht **2x 14,5L**

Maht **14,5L + 2x 7,5L** Hind €
121.0494.150 **42.-**
Maht **14,5L + 2x 7,5L**

Maht **14L + 2x 8L** Hind €
134.0055.293 **105.-**
Maht **14L + 2x 8L**

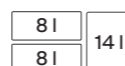

40 cm



MARIS

15 18
20 22
23



Cube 40
Aluskapp: 40 cm
Mõõdud: 335 x 407 x 348 mm
Sorteri tüüp: küljele avaneva uksega avanev
Paigaldamine: kapi põhjale kinnitav

Erimärkused:
-Vajalik 110° avanevad uksehinged

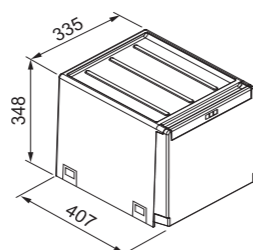

Cube 40

Maht 2x 14L Hind €

134.0039.332 93.-
Maht 2x 14L



Maht 14L + 2x 7L

134.0039.331 97.-
Maht 14L + 2x 7L

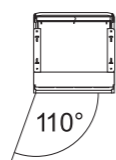
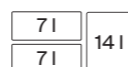

SMART



SORTER PIVOT
Aluskapp: 40 cm
Mõõdud: 340 x 340 x 410 mm
Sorteri tüüp: küljele avaneva uksega avanev
Paigaldamine: kinnitatakse külgsainte külge, universaalne

Erimärkused:
- plastist raam prügikottide kinnitamiseks
- põhikapis tuleks kasutada amortisaatoritega hingesid
- plastik riul prügikasti kaanena

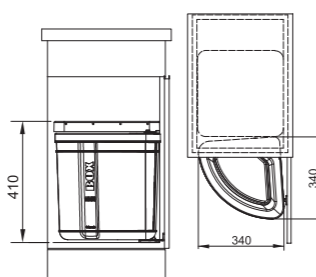

Sorter Pivot

Maht 27L Hind €

121.0307.563 84.-
Maht 27L



SMART



SORTER MINI
Aluskapp: 40 cm
Mõõdud: 310 x 310 x 348 mm
Sorteri tüüp: küljele avaneva uksega avanev
Paigaldamine: kinnitatakse külgsainte külge, universaalne

Erimärkused:
- plastist raam prügikottide kinnitamiseks
- plastik riul prügikasti kaanena

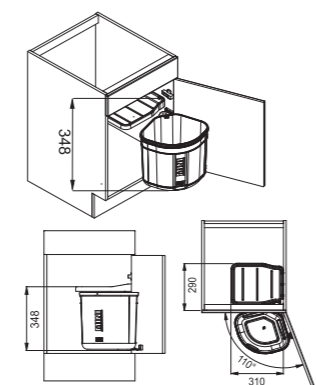

Sorter Mini

Maht 17L Hind €

121.0176.518 29.-
Maht 17L



30 cm



MARIS

12 13
14



Cube 30
Aluskapp: 30 cm
Mõõdud: 253 x 467 x 433 mm
Sorteri tüüp: Käsiitsi avatav (sorter ukse taga)
Paigaldamine: kapi põhjale kinnitav

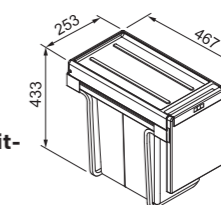

Cube 30

Maht 2x 15L Hind €

134.0039.553 68.-
Maht 2x 15L



Maht 20L + 10L

134.0039.554 69.-
Maht 20L + 10L



Maht 3x 10L

134.0039.555 73.-
Maht 3x 10L



Täiendavad lisad sorteerimissüsteemidele

01

133.0251.264
Sangaga plastikust jäätmemahuti 8 L
150 x 225 x 340 mm
16.- €



02

133.0251.265
Sangaga plastikust jäätmemahuti 12 L
150 x 300 x 340 mm
18.- €



03

133.0251.269
Sangaga plastikust jäätmemahuti 12 L
225 x 225 x 340 mm
18.- €



04

133.0251.270
Sangaga plastikust jäätmemahuti 18 L
225 x 300 x 340 mm
20.- €



05

133.0200.694
Plastikust kaas jäätmemahutile, antratsiit 8 L
8.- €



06

133.0200.695
Plastikust kaas jäätmemahutile, antratsiit 12 L
10.- €



07

133.0200.698
Aktiivsöefiltriga jäätmemahutite plastkaas 8 L
15.- €



08

133.0200.699
Aktiivsöefiltriga jäätmemahutite plastkaas 12 L
20.- €



09

133.0284.696
Plastikust kaas jäätmemahutile, antratsiit 18 L
10.- €



10

133.0284.697
Aktiivsöefiltriga jäätmemahutite plastkaas 18 L
20.- €



11

133.0251.271
Plastikust jäätmemahuti 125 x 165 x 75 mm
5.- €



12

133.0042.702
Sangaga plastikust jäätmemahuti 20 L
230 x 295 x 365 mm
14.- €



13

133.0042.696
Sangaga plastikust jäätmemahuti 15 L
230 x 220 x 365 mm
10.- €



14

133.0042.678
Sangaga plastikust jäätmemahuti 10 L
230 x 150 x 365 mm
10.- €



15

133.0023.966
Sangaga plastikust jäätmemahuti 14 L
315 x 185 x 290 mm
22.- €



16

133.0016.358
Sangaga plastikust jäätmemahuti 18 L
310 x 220 x 290 mm
24.- €



17

133.0016.359
Sangaga plastikust jäätmemahuti 8 L
220 x 160 x 290 mm
18.- €



18

133.0039.556
Sangaga plastikust jäätmemahuti 7 L
150 x 180 x 290 mm
16.- €



19

133.0014.739
Plastikust kaas jäätmemahutile, antratsiit 18 L
20.- €



21

133.0014.278
Jäätmemahuti plastkaas 8 L
16.- €



22

133.0016.354
Värvilised kilekottide hoidjad
3.- €



23

134.0039.317
Cube 10 väljatõmmatav sahtel 93 x 407 x 348 mm
39.- €

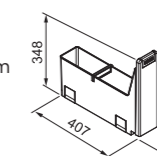

ELITE SLIM JÄÄTMEPU- RUSTAJAD



Tänu uutele Franke Elite Slimline jäätmepurustajatele on pärast sööki koristamine sama lihtne kui toiduvalmistamine. Need on loodud perede abistamiseks nende igapäevaste toimetuste tegemisel. Toidujäätmeid purustades ja utiliseerides vähendate bakterite ja lõhnade ohtu köögis, samuti jätkusuutlikum lähenemine oma igapäevasele köögrutiinile.



Tugev jõudlus

Tänu uuenduslikule Twist Force tehnoloogiale, mis pakub suurepäraselt purustusjõudu, võite oodata kiireid ja tõhusaid tulemusi ilma masinat segamata. Hügieeniline kaitsekate võitleb ka bakterite kasvu ja ebameeldiva lõhna vastu, mida pakub antibakteriaalne kaitse.

Veenvad detailid

Igal jäätmepurustil on kummist pritsmekaitse, mis tagab, et soovimatud esemed ei satuks purustuskambrisse. Müra kõrvaldatakse heli summutustehnoloogia abil. Teatud mudelite tugev magnetkaar tagab, et metallist esemed ei satuks purustuskambrisse.



Elegantsus valamu all

3 poldi kinnitussüsteemiga, mis muudab selle ühilduvaks kõigi Franke valamutega, millel on 3 1/2 tolline ventiil, ja elegantne korpus, mis on loodud rohkem ruumi säästma valamu all on iga Elite Slimline jäätmepurustaja näide Franke uuendusest, mis on kena täiendus igasse kööki



MARIS

01 02
03 04
05 06
07 08
09 10



Võimsus: 1,25 hj
Keerutamine: pidev ühesuunaline
Pööret minutis: 2800
Heli neelav korpus
Roostevabast terasest purustuskamber
Twist Force tasakaalustatud purustusüsteem
Vastupidav kinnikiilumisele
Massiivsed metallist purustuselemendid
Eemaldatav antibakteriaalne pritsmekaitse
Magnetrõngas kaitseks metalli eest teemasid
3 kruviga kinnitus
Integreeritud õhulüliti koos ühendustoruga

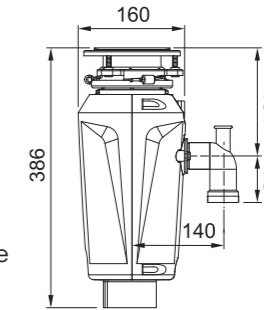

Slim 125
Jäätmepurustajad
Hind €
134.0715.094 320.-
1.25 HP

MARIS

01 02
03 04
05 06
07 08
09 10



Võimsus: 0,75 hj
Keerutamine: pidev ühesuunaline
Pööret minutis: 2800
Heli neelav korpus
Roostevabast terasest purustuskamber
Twist Force tasakaalustatud purustusüsteem
Vastupidav kinnikiilumisele
Massiivsed metallist purustuselemendid
Eemaldatav antibakteriaalne pritsmekaitse
3 kruviga kinnitus
Integreeritud õhulüliti koos ühendustoruga

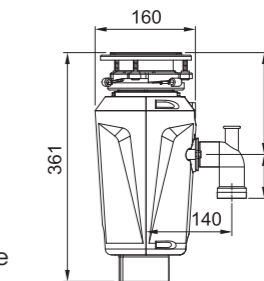

Slim 75
Jäätmepurustajad
Hind €
134.0715.096 272.-
0.75 HP

MARIS

01 02
03 04
05 06
07 08
09 10



Võimsus: 0,5 hj
Keerutamine: pidev ühesuunaline
Pööret minutis: 2800
Heli neelav korpus
Roostevabast terasest purustuskamber
Twist Force tasakaalustatud purustusüsteem
Vastupidav kinnikiilumisele
Massiivsed metallist purustuselemendid
Eemaldatav antibakteriaalne pritsmekaitse
3 kruviga kinnitus
Integreeritud õhulüliti koos ühendustoruga

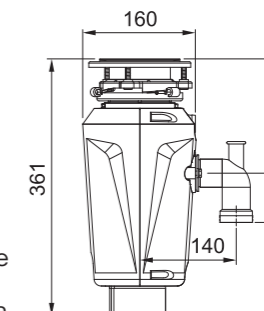

Slim 50
Jäätmepurustajad
Hind €
134.0715.098 223.-
0.5 HP

Valikulised lisad



112.0277.144
Universaalne Ülevoolu
ühenduskomplekt
19.- €



112.0674.415
Mustad nupud jäätmepurusti
juhtimiseks
25.- €

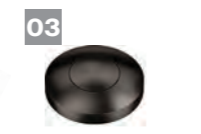

112.0664.346
Nupud jäätmepurusti
juhtimiseks - Antratsiit
20.- €

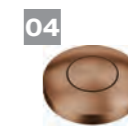

112.0664.348
Nupud jäätmepurusti
juhtimiseks - vask
20.- €



112.0664.347
Nupud jäätmepurusti
juhtimiseks - Šampanjakuldne
20.- €



112.0664.350
Jäätmete kogumisventiili
rõngas koos kaanega -
Vask
40.- €



112.0664.394
Jäätmete kogumisventiili
rõngas koos kaanega -
Vask
40.- €



112.0664.391
Jäätmete kogumisventiili
rõngas koos kaanega -
Šampanjakuldne
40.- €



112.0657.421
Võrkvorviga prügipurusti
klapirõngas - Must matt
36.- €



112.0489.809
Keraamiliste valamute jaoks
mõeldud jäätmepurustaja
kinnituse pikendus
18.- €

Valamute lisatarvikute

ühilduvustabel

Mudel	Lk.	112.0676.854 Plastikust löikepind 240 x 429 x 15 mm 177.- €	112.0591.082 Lõikelaud Paper- Stone Slate grey 180 x 412 mm 139.- €	112.0595.334 Puidust lõikelaud 532 x 280 mm 80.- €	112.0655.342 112.0655.344 112.0655.343 Rullmatt 468 x 440 mm 304.- €	112.0080.355 Rullmatt 468 x 440 mm 90.- €	112.0030.882 Rullmatt 468 x 420 mm 86.- €	112.0591.081 Rullmatt 252 x 424 mm 68.- €	112.0655.472 112.0655.470 112.0655.471 Tavaline metallrest kraanikausile 491 x 401 mm 203.- €	112.0655.468 112.0655.431 112.0655.433 Tavaline metallrest kraanikausile 391x401mm 161.- €	112.0204.360 Rv Mobiilne nõruti plastik raamis 326x440x22mm 129.- €	112.0602.288 Rv Mobiilne nõruti plastik raamis 298 x 412 mm 108.- €	112.0188.651 Rv Mobiilne nõruti plastik raamis 342 x 430 x 22 mm 120.- €	112.0655.341 112.0655.239 112.0655.240 Nõrutuskauss- roostevaba teras plastik käepideme 157x429x54mm 169.- €	112.0659.398 Roostevabast terasest nõru- tuskauss plas- tkäepideme- tega 159x416x54 mm 66.- €	112.0394.981 Roostevabast terasest nõru- tuskauss plas- tkäepideme- tega 429 x 156 mm 116.- €	112.0520.497 Roostevabast terasest kandik 172x412x55mm 82.- €	112.0461.942 Roostevabast terasest kandik 297 x 187 x 72 mm 45.- €	112.0619.946 Andy Chef - tarvikute komplekt 408x133x200 mm 493.- €	ALL-IN 5 erinevat kom- plekti ALL IN (rohkem lk 125) valamule: 340 x 540 mm 135.- ... 258.- €	
Mythos Masterpiece																					
BXM 210/110-50	31,95	x			x				x						x						
BXM 210/110-40	31,95	x			x					x					x						
Mythos																					
MYX 210-50	33		x					x				x				x					
MYX 210-45	33		x					x				x				x					
MYX 110-50	97		x					x				x				x					x
MYX 110-45	97		x					x				x				x					x
Box Centre																					
BWX 220-54-27 A	35										x										
Box																					
BXX 210/110-68	36,100					x					x						x				x
BXX 210/110-54	37,101					x					x						x				x
BXX 210/110-50	37,101					x					x						x				x
BXX 210/110-45	37,101					x					x						x				x
BXX 210/110-40	38,102					x					x						x				x
BXX 210/110-34	39,103					x					x						x				x
BXX 210/110-16	39,103																	x			
Maris Quiet																					
MQX 110-82	99																				x
MQX 110-50	99																				x
Maris																					
MRX 210-70TL	41						x							x				x			x
MRX 210-50TL	41						x							x				x			x
MRX 210-40TL	41						x							x				x			x
MRX 210-70	42						x							x				x			x
MRX 210-55	43						x							x				x			x
MRX 210-50	43						x							x				x			x
MRX 210-45	43						x							x				x			x
MRX 210-40	44						x							x				x			x
MRX 210-34	44						x							x				x			x
MRX 160-34-19	105						x							x				x			x
MRX 110-70	105						x							x				x			x
MRX 110-55	105						x							x				x			x
MRX 110-50	106						x							x				x			x
MRX 110-45	107						x							x				x			x
MRX 110-40	107						x							x				x			x
MRX 110-34	107						x							x				x			x
Aton																					
ANX 110-48	109						x							x				x			x
ANX 110-34	109						x							x				x			x
Bell																					
BCX 610-51	45																				x
Spark																					
SKX 651	46			x																	x
SKX 611-86	47			x																	x
SKX 611-78/50	47			x																	x
SKN 611-78/44	47																				x
SKN 611-86/44	48																				x
SKX 611-62/50	49																				x
SKL 611-62/50	49			x																	x
SKN 611-62/44	49																				x
SKN 610-37/44	49																				x
SKX 620-86	50			x																	x
SKX 621	50			x																	x
SKX 651-95-E	50																				x
Smart																					
SRX 110-50	110												x								x
SRX 110-45	111												x								x
SRX 110-40	111												x								x
SRX 110-34	111												x								x
Rapid																					
RPX 611-86XL	51			x																	x
Antea																					
AZN 651	52			x																	x
AZN 611-62	52			x																	x
Ronda																					
ROX 610-39	53																				
RON 610-39	53																				
ROL 610-39	53																				
ROX 610/110-38	53																				

Valamute lisatarvikute

ühilduvustabel

















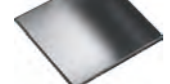

















Mudel	Lk.																		
Fragraniit valamud																			
Kubus 2																			
KNG 110-62	113																		
KNG 110-52	113																		
KNG 110-37	113																		
Maris																			
MRG 651-78	58					X								X		X			X
MRG 611-100XL	59					X								X					X
MRG 611-78XL	59					X								X					X
MRG 611-62	59					X								X					X
MRG 612-E	60							X						X					X
MRG 610-72A	63							X											X
MRG 610-54A	64							X						X					X
MRG 610-52A	65							X						X					X
MRG 610-39 A	66							X						X					X
MRG 610-37A	67							X						X					X
MRG 110-72	114							X						X					X
MRG 110-52	115							X						X					X
MRG 110-37	115							X						X					X
MRG 210-72	117							X						X					X
MRG 210-72A	117							X						X					X
MRG 210-52	119							X						X					X
MRG 210-52A	119							X						X					X
MRG 210-37	121							X						X					X
MRG 210-37A	121							X						X					X
Maris Care																			
MRG 610-60 CARE	61	X							X					X					X
Urban																			
UBG 651-100	68					X								X			X		X
UBG 611-100	69					X								X					X
UBG 611-78XL	69					X								X					X
UBG 611-62	71					X								X					X
UBG 610-56	71					X								X					X
Centro																			
CNG 611-86	73					X													X
CNG 611-78	73					X													X
CNG 611-62	73					X													X
Basis																			
BFG 651	74					X													X
BFG 651-78	75					X													X
BFG 611	75					X													X
BFG 611-62	75					X													X
Tektoniit Valamud																			
Sirius																			
S2D 651	82					X												X	X
S2D 611-100	83					X												X	X
S2D 611-78	83					X												X	X
S2D 611-78XL	83					X												X	X
S2D 611-62	84					X												X	X
SID 610	84																		X
SID 610-40	84																		X
Single																			
Single	85																		X
Fraceram																			
Mythos																			
MYK 610-52 A	89				X					X						X			
MYK 611-100	89				X					X						X			
Kubus X																			
KXX 110-71	122		X							X									X
KXX 160-37-12	123		X							X									X
KXX 110-51	123		X							X									X
KXX 110-41	123		X							X									X

Ventiilide komplektid valamutele

Mudel	Põhikomplekt	Väikese kausi ventii	Ülevool 1	Ülevool 2	Vajutusnupp	Ühendustorud	Äravoolukate
ATON							
ANX 110-48 / ANX 110-34	112.0738.024						
BASIS							
BFG 651 / BFG 651-78	112.0568.434						
BFG 611 / BFG 611-62	112.0567.978						
BELL							
BCX 610-51	112.0626.585						
BOX CENTRE							
BWX 220-54-27A	112.0301.698	112.0049.409	112.0671.788	112.0671.788	112.0705.730	112.0048.209	112.0532.169
Franke BOX Ekscentrinis							
BXX 210/110-68	112.0301.673		112.0671.788		112.0705.730	112.0657.770	
BXX 210/110-54	112.0301.673		112.0671.788		112.0705.730	112.0657.770	
BXX 210/110-50	112.0301.673		112.0671.788		112.0705.730	112.0657.770	
BXX 210/110-45	112.0301.673		112.0671.788		112.0705.730	112.0657.770	
BXX 210/110-40	112.0301.673		112.0671.788		112.0705.730	112.0657.770	
BXX 210/110-16	112.0301.673		112.0671.787		112.0705.730	112.0657.770	
Franke BOX Rankinis vožtuvas							
BXX 210/110-68	112.0680.823						
BXX 210/110-54	112.0680.823						
BXX 210/110-50	112.0680.823						
BXX 210/110-45	112.0680.823						
BXX 210/110-40	112.0680.823						
BXX 210/110-34	112.0680.823						
BXX 110-16	112.0671.019						
CENTRO							
CNG 611-86	112.0625.613						
CNG 611-78	112.0625.613						
CNG 611-62	112.0625.613						
KUBUS 2							
KNG 110-62	112.0389.090		112.0671.891		112.0705.730	112.0657.770	112.0395.171
KNG 110-52	112.0389.090		112.0671.891		112.0705.730	112.0657.770	112.0395.171
KNG 110-37	112.0389.090		112.0671.891		112.0705.730	112.0657.770	112.0395.171
KUBUS X							
KXK 160	112.0704.849	112.0735.379				112.0644.115	
KXK 110-51	112.0704.849		112.0673.948			112.0657.770	
KXK 110-41	112.0704.849		112.0673.948			112.0657.770	
KXK 110-71	112.0704.849		112.0673.948			112.0657.770	
MARIS Rankinis vožtuvas							
MRX 210-70TL	112.0049.409		112.0671.845				
MRX 210-50TL	112.0049.409		112.0671.845				
MRX 210-40TL	112.0049.409		112.0671.845				
MRX 160-34-19	112.0049.409	112.0049.409	112.0671.845				
MRX 210-70/110-70	112.0049.409		112.0671.845				
MRX 210-55/110-55	112.0049.409		112.0671.845				
MRX 210-50/110-50	112.0049.409		112.0671.845				
MRX 210-45/110-45	112.0049.409		112.0671.845				
MRX 210-40/110-40	112.0049.409		112.0671.845				
MRX 210-34/110-34	112.0049.409		112.0671.845				
MARIS Ekscentrinis							
MRG 651-78	112.0544.161	112.0604.332	133.0537.934			112.0644.115	
MRG 611-100 XL	112.0687.564						
MRG 611-78 XL	112.0687.564						
MRG 611-62	112.0687.564						
MRG 612-E	112.0687.564						
MRG 610-37 A	112.0544.161		112.0671.891		112.0705.730	112.0657.770	112.0532.169
MRG 610-39 A	112.0544.161		112.0671.891		112.0705.730	112.0657.770	112.0532.169
MRG 610-52 A	112.0544.161		112.0671.891		112.0705.730	112.0657.770	112.0532.169
MRG 610-54 A	112.0544.161		112.0671.891		112.0705.730	112.0657.770	112.0532.169
MRG 110-37 / MRG 110-52	112.0544.161		112.0671.849		112.0705.730	112.0657.770	112.0532.169
MARIS Rankinis vožtuvas							
MRG 110-37 / MRG 210-37	112.0604.234		112.0671.849			112.0657.770	112.0532.169
MRG 610-37 A	112.0604.234		112.0671.891			112.0657.770	112.0532.169
MRG 110-52 /MRG 210-52 A	112.0604.234		112.0671.849			112.0657.770	112.0532.169
MRG 610-52 A	112.0604.234		112.0671.891			112.0657.770	112.0532.169
MRG 610-54 A	112.0604.234		112.0671.891			112.0657.770	112.0532.169
MRG 110-72 / MRG 210-72	112.0604.234		112.0671.849			112.0657.770	112.0532.169
MRG 610-72 A	112.0604.234		112.0671.891			112.0657.770	112.0532.169





Mudel	Põhikomplekt	Väikese kausi ventii	Ülevool 1	Ülevool 2	Vajutusnupp	Ühendustorud	Äravoolukate
MARIS Juoda Ekscentrinis							
MRG 110-37	112.0658.446					112.0657.770	
MRG 210-37	112.0658.446					112.0657.770	
MRG 210-37 A	112.0658.446					112.0657.770	
MRG 610-37 A	112.0658.446					112.0657.770	
MRG 110-52	112.0658.446					112.0657.770	
MRG 210-52	112.0658.446					112.0657.770	
MRG 210-52 A	112.0658.446					112.0657.770	
MRG 610-52 A	112.0658.446					112.0657.770	
MRG 110-72	112.0658.446					112.0657.770	
MRG 210-72 A	112.0658.446					112.0657.770	
MRG 610-72 A	112.0658.446					112.0657.770	
MARIS Juoda							
MRG 110-37 / MRG 210-37	112.0658.444					112.0657.770	
MRG 610-37 A	112.0658.444					112.0657.770	
MRG 110-52	112.0658.444					112.0657.770	
MRG 210-52 A	112.0658.444					112.0657.770	
MRG 610-52 A	112.0658.444					112.0657.770	
MRG 110-72 / MRG 210-72	112.0658.444					112.0657.770	
MRG 610-72 A	112.0658.444					112.0657.770	
MYTHOS MASTERPIECE							
BMX Man - Antracita	112.0653.030					112.0657.770	
BMX Man - Zelta	112.0652.898					112.0657.770	
BMX Man - Vara	112.0652.978					112.0657.770	
BMX Exc - Antracita	112.0653.035					112.0657.770	
BMX Exc - Zelta	112.0653.036					112.0657.770	
BMX Exc - Vara	112.0653.041					112.0657.770	
MYTHOS							
MYX 210-70	112.0301.673		112.0671.845		112.0705.730		112.0532.169
MYX 210-50 (110-50)	112.0301.673		112.0671.845		112.0705.730		112.0532.169
MYX 210-45 (110-45)	112.0301.673		112.0671.845		112.0705.730		112.0532.169
RAPID							
RPX 611-86XL	112.0667.490						
RONDA							
ROG 611	112.0579.522						
ROG 610-41 Excenter	112.0567.976						
ROG 610-41 Manual	112.0685.892						
RONDO							
RON/ROL/ROX	112.0332.276		112.0672.079			112.0657.770	
SINGLE							
Single	112.0596.031						
SIRIUS							
S2D 651	112.0595.930						
S2D 611-100 / S2D 611-78	112.0570.866						
S2D 611-78XL / S2D 611-62	112.0570.866						
SID 610 / SID 610-40	112.0685.892						
SPARK							
SKN 610-37/44	112.0692.357						
SKN 611-62/44	112.0692.357						
SKN 611-78/44	112.0692.357						
SKL 611-78/44	112.0692.357						
SKN 611-86/44	112.0692.357						
SKL 611-62 / SKX 611-62	112.0680.185						
SKX 611-78 / SKX 611-86	112.0680.185						
SKX 621 / SKX 651	112.0689.188						
SKX 651-95 E	112.0689.188						
SKX 620-34-34/86	112.0661.923						
SMART							
SRX 110	112.0049.409						
URBAN							
UBG 610-50	112.0598.003						
UBG 610-50 Black	112.0656.939			112.0734.782			
UBG 611-62/78L/100	112.0625.583						
UBG 611-62/78L/100 Black	112.0656.939			112.0734.782			
UBG 651	112.0597.969						
UBG 651 Black	112.0656.939	112.0668.276		112.0734.782			











Lisad

 112.0473.656 Augufrees 35mm Fragraniit ja Tektoniit valamutele 6.- €	 112.0008.476 Augu 35mm jaoks 46.- €	 112.0006.333 Roostevaba terasest valamu augu kate 35mm augu jaoks 3.- €	 112.0085.384 Roostevabast terasest valamu kinnituskomplekt kleebise ja tihendiga 5.- €	 112.0366.355 Kinnitusdetail põhjaklapi ümarmarguse surunupu paigaldamiseks kapi sisemusse. 48.- €
 112.0532.169 Roostevabast terasest klapi kate. Sobib Mythos, Box Center ja Maris uhekaasilised valamud. 10.- €	 112.0395.171 Nelinurkne ventiili kate roostevabast terasest 8.- €	 112.0331.971 3½" eksenterventiil (nupuga avatav) 36.- €	 112.0307.597 Ventiil 3½" käsijuhtimisega 15.- €	 112.0301.673 3½" eksenterventiil (nupuga avatav) 48.- €
 112.0705.730 Ümar vajutusnupp roostevabast terasest 70.- €	 112.0389.090 3½" eksenterventiil (nupuga avatav) 48.- €	 112.0331.953 3½" eksenterventiil (nupuga avatav) 36.- €	 112.0307.599 Ventiil 3½" käsijuhtimisega 18.- €	 112.0049.409 Ventiil 3½" käsijuhtimisega 20.- €
 112.0657.770 Ühendus sifooni 2" jaoks 8.- €	 112.0006.412 Universaalne ruumisäästlik sifoon 2" 1 m 7.- €	 112.0006.456 Painduva ühendusega sifoon 2" 12.- €	 133.0297.561 Mudafilter, lihtne hooldada, ¾" ühendusega (2 tk) 38.- €	 112.0304.193 Puhastuskäsna komplekt 4.- €
 112.0657.146 Must klapi kate on mõeldud Maris sarja üheosalistele valamutele 11.- €	 112.0658.197 Klapikomplekt klapi juhtnupuga, must ümmargune ülevool, must nupp sulgemiseks ja avamiseks 76.- €	 112.0658.446 Klapikomplekti klapi juhtimine nupuga, musta nurgaülevool, must nupp sulgemiseks ja avamiseks 72.- €	 112.0658.280 Klapikomplekt koos klapi juhtimisega kaks kausi valamut, must ümmargune ülevool, must nupp 90.- €	 112.0658.444 Klapikomplekt käsitsi ventiiliga musta nurga ülevooluga 38.- €
 112.0653.030 Antratsiit ventiil 3½" käsijuhtimisega (ventiil 3½" ülevooluga) 282.- €	 112.0652.898 Šampanjakuldne ventiil 3½" käsijuhtimisega (ventiil 3½" ülevooluga) 282.- €	 112.0652.978 Vask ventiil 3½" käsijuhtimisega (ventiil 3½" ülevooluga) 282.- €	 133.0630.101 Antratsiit kandiline ülevoolukate 20.- €	 133.0630.111 Šampanjakuldne kandiline ülevoolukate 20.- €
 112.0653.035 Antratsiit 3½" eksenterventiil (Ventiil 3½", ülevooluga, ümar vajutusnupp) 354.- €	 112.0653.036 Šampanjakuldne 3½" eksenterventiil (Ventiil 3½", ülevooluga, ümar vajutusnupp) 354.- €	 112.0653.041 Vask 3½" eksenterventiil (Ventiil 3½", ülevooluga, ümar vajutusnupp) 354.- €	 133.0630.057 Vask kandiline ülevoolukate 20.- €	

 112.0007.715 Franke Twister käsnauga 125 ml 8.- €	 112.0007.459 Franke Twister käsnauga komplektis karbis 12x 125 ml 86.- €	 112.0530.324 HOOLDUSVAHEND mikrokiust lapp 12.- €	 112.0530.238 HOOLDUSVAHEND Segistite jaoks 250 ml 14.- €	 112.0530.240 HOOLDUSVAHEND Õhupuhastite jaoks 250 ml 14.- €
---	--	---	--	---

Ikoonide selgitused

-  Kangsegisti: segistil on jääk otsik st ilma väljatõmmatava voolikut.
-  Väljatõmmatava voolikuga: Segistil on väljatõmmatav voolik. Otsikul on tavaline juga.
-  Kuulühendus. Veetoru ei saa tänu kuulühendusele pöörelda ning toimib liikuva üleminekuna veetoru ja väljatõmmatava otsaku vahel.
-  Laminaarse voolu aeraator eraldab vähem pritsmeid
-  Akna ette monteeritav: ideaalne akna ette paigaldamiseks.
-  Pöördeulatus: näitab kui suures ulatuses on võimalik jooksutoru pöörata.
-  Kang mõlemal küljel: võimalik on monteerida kang paremal või vasakul.
-  Kang keskel: Segistil on kang üleval.
-  Kang paremal: Segisti saab monteerida ainult kang paremal.
-  Ühildub Active L Twist

-  Aluskapp cm.
-  Vajutusnupp: Põhjasõela avamine ja sulgemine vajutusnupuga. Vee väljavool on avatud, kui nupp on valamuga ühes tasapinnas.
-  Pöördnupp: põhjasõela avamine ja sulgemine pöördnupuga.
-  Käsitsi: käega põhjasõela kergitamiseks avatakse vee väljavool ja põhjasõela vajutamiseks suletakse vee väljavool.
-  Kahepoolne valamud.
-  Integreeritud äravool: väljavoolu ülemine osa on pressitud valamud põhja. Nii on valamud põhi täiesti sile ilma tihenditeta, seega väga hügieeniline.
-  Jäätmepurustaja ühendamine on võimalik
-  Süvistatav
-  Tasapinnaline
-  SlimTop valamud.
-  Altpoolt monteeritav

FRANKE TOOTE KATALOOG sisaldab informatsiooni praeguse tootevaliku kohta. Kommentaarid toodete saadavuse kohta on toodetel mis tulevikus asendatakse teiste sarnaste ja täiustatud toodetega ning uute artiklumberidega. Toodete saadavuse kohta pärast ette antud tähtaegu, palun kontakteeruge Franke ametlike maaletootajatega.

Tähelepanu! Hinnad on soovituslikud jaehinnad ja sisaldavad käibemaksu 24%. Tootepildid on illustratiivsed, näiteks toode ei tarvitse sisaldada pildil toodud nõrutuskausi (jälgi alati tootekirjeldust!). Valamul ja segistil võivad võrreldes tootenäidistega esineda tehnoloogias tulenevat värvierinevust. Tehniliste uuenduste tõttu võivad tooted erineda kataloogis toodud toodetest. Franke ei võta endale vastutust kataloogis esinevate eksimuste, näiteks trükivigade eest. Kõigile toodetele kehtib garantii 2 aastat juhul, kui on järgitud paigaldus- ja kasutusjuhendit.

Garantiitööd, remont ja varuosad:
Eliser OÜ
Mustamäe tee 24,
Tallinn
teenindus@eliser.ee
tel: 6650090
INTERNET
Kõige värskema info saab alati leida www.franke.ee/ks
YOUTUBE
Vaata meid youtube kanalis www.youtube.com/user/Franke-KitchenSystem
KATALOOG
Kataloogi ja muud materjalid PDF-formaadis saab alla laadida www.franke.ee/ks

Franke art.nr. registrid

101					
101.0463.814	52	112.0473.656	62, 64, 66, 68, 70, 72, 74, 112, 114, 116, 118, 120, 186, 192	112.0664.394	185
101.0464.044	46			112.0674.415	185
101.0464.337	47	112.0489.809	185	112.0676.854	30, 94
101.0469.740	50	112.0512.280	82, 85	112.0688.102	60
101.0498.889	51	112.0530.240	192	112.0705.730	186
101.0622.893	45	112.0530.324	192	112.0717.084	136, 138, 142, 144, 175
101.0714.945	47	112.0532.169	186	112.0717.102	136, 138, 142, 144, 175
101.0714.948	49	112.0539.120	34	112.0717.103	136, 142, 144, 175
101.0714.950	50	112.0539.134	34	112.0717.104	136, 142, 144, 175
101.0714.951	50	112.0539.135	34	112.0717.105	136, 142, 144, 175
101.0714.957	49	112.0539.138	34	112.0726.571	175
101.0714.971	53	112.0545.792	34	112.0735.488	122
101.0714.972	53	112.0548.292	34	112.0741.539	72
101.0725.057	53	112.0566.182	68	112.0747.050	112
101.0727.747	52	112.0579.124	192	112.0747.094	88
101.0729.488	49	112.0591.081	32, 96	112.0747.151	88
101.0729.489	48	112.0591.082	32, 96	112.0749.981	34
101.0729.490	47	112.0595.334	46, 48, 51, 52, 58, 68, 70, 72, 74, 82, 85	114	
101.0729.492	47			114.0009.505	77
101.0729.493	49	112.0602.288	32, 96	114.0009.506	77
101.0734.373	53	112.0607.497	131	114.0009.509	77
112		112.0607.498	131	114.0009.542	77
112.0006.138	51	112.0619.946	36, 38, 100, 102	114.0009.543	77
112.0006.333	186	112.0652.898	187	114.0009.546	77
112.0006.412	186	112.0652.978	187	114.0029.528	76
112.0006.456	186	112.0653.030	187	114.0031.171	76
112.0007.459	192	112.0653.035	187	114.0197.774	60
112.0007.715	192	112.0653.036	187	114.0199.717	77
112.0008.476	186	112.0653.041	187	114.0199.718	77
		112.0655.239	30, 94	114.0253.322	59
112.0030.882	40, 42, 44, 43, 64, 66, 88, 104, 106, 108, 114, 116, 118, 120, 122	112.0655.240	30, 94	114.0253.323	59
112.0049.409	186	112.0655.341	30, 94	114.0253.324	59
112.0057.214	58	112.0655.342	30, 94	114.0253.333	58
112.0520.497	38, 40, 42, 44, 102, 104, 106, 108	112.0655.343	30, 94	114.0253.334	58
112.0066.060	58, 60, 68, 70, 112	112.0655.431	30, 94	114.0253.335	58
112.0071.973	98	112.0655.433	30, 94	114.0256.609	75
112.0080.355	36, 38, 60, 100, 102	112.0655.468	30, 94	114.0256.610	75
112.0085.384	186	112.0655.470	30, 94	114.0256.611	75
		112.0655.471	30, 94	114.0256.612	75
112.0188.651	40, 42, 44, 62, 64, 66, 104, 106, 108, 110, 114, 116, 118, 120	112.0655.472	30, 94	114.0256.624	74
112.0188.653	88, 122	112.0655.481	125	114.0256.625	74
112.0204.360	34, 36, 38, 100, 102, 112	112.0655.482	125	114.0256.626	74
112.0256.867	58, 112	112.0655.483	125	114.0256.627	74
112.0277.144	98, 185	112.0655.488	125	114.0301.331	75
112.0301.673	186	112.0655.489	125	114.0301.333	75
112.0304.193	192	112.0657.146	187	114.0301.335	75
112.0307.597	186	112.0657.421	185	114.0301.342	75
112.0307.599	186	112.0657.770	186	114.0301.345	75
112.0331.953	186	112.0658.197	187	114.0301.367	75
112.0331.971	186	112.0658.280	187	114.0301.368	75
112.0366.355	186	112.0658.444	187	114.0301.370	75
112.0389.090	186	112.0658.446	187	114.0301.903	75
112.0394.981	36, 38, 100, 102	112.0659.398	32, 96	114.0301.907	75
112.0395.171	186	112.0664.346	185	114.0301.951	75
112.0461.942	46, 52	112.0664.347	185	114.0301.961	74

114.0316.528	77	114.0658.583	67	114.0658.583	67
114.0368.449	84	114.0658.586	65	114.0658.586	65
114.0368.467	84	114.0658.588	63	114.0658.588	63
114.0378.095	59	114.0659.123	67	114.0659.123	67
114.0378.121	59	114.0659.124	65	114.0659.124	65
114.0378.124	59	114.0659.125	63	114.0659.125	63
114.0378.126	59	114.0681.426	73	114.0681.426	73
114.0463.691	85	114.0681.427	73	114.0681.427	73
114.0463.694	85	114.0681.428	73	114.0681.428	73
114.0463.698	85	114.0681.429	73	114.0681.429	73
114.0463.958	84	114.0681.430	73	114.0681.430	73
114.0479.022	59	114.0681.581	73	114.0681.581	73
114.0479.027	59	114.0681.583	73	114.0681.583	73
114.0479.030	59	114.0681.584	73	114.0681.584	73
114.0479.032	59	114.0681.585	73	114.0681.585	73
114.0499.970	84	114.0681.586	73	114.0681.586	73
114.0500.012	84	114.0682.458	73	114.0682.458	73
114.0500.019	84	114.0682.459	73	114.0682.459	73
114.0627.289	58	114.0682.460	73	114.0682.460	73
114.0627.363	59	114.0682.501	73	114.0682.501	73
114.0627.365	59	114.0682.502	73	114.0682.502	73
114.0657.807	74	114.0682.525	69	114.0682.525	69
114.0657.808	75	114.0682.526	68	114.0682.526	68
114.0657.810	75	114.0682.528	69	114.0682.528	69
114.0657.822	75	114.0682.529	69	114.0682.529	69
114.0658.140	67	114.0682.530	69	114.0682.530	69
114.0658.216	67	114.0682.532	68	114.0682.532	68
114.0658.217	67	114.0682.533	68	114.0682.533	68
114.0658.218	67	114.0682.534	68	114.0682.534	68
114.0658.219	67	114.0682.545	71	114.0682.545	71
114.0658.220	67	114.0682.547	71	114.0682.547	71
114.0658.254	67	114.0682.548	71	114.0682.548	71
114.0658.255	67	114.0682.549	71	114.0682.549	71
114.0658.256	67	114.0682.565	69	114.0682.565	69
114.0658.257	67	114.0682.567	69	114.0682.567	69
114.0658.293	65	114.0682.569	69	114.0682.569	69
114.0658.294	65	114.0682.570	69	114.0682.570	69
114.0658.295	65	114.0682.600	71	114.0682.600	71
114.0658.296	65	114.0682.642	71	114.0682.642	71
114.0658.297	65	114.0682.643	71	114.0682.643	71
114.0658.298	65	114.0682.644	71	114.0682.644	71
114.0658.299	65	114.0682.733	69	114.0682.733	69
114.0658.300	65	114.0682.734	68	114.0682.734	68
114.0658.301	65	114.0682.735	71	114.0682.735	71
114.0658.302	65	114.0682.737	69	114.0682.737	69
114.0658.310	63	114.0682.738	71	114.0682.738	71
114.0658.331	63	114.0700.628	77	114.0700.628	77
114.0658.332	63	114.0700.629	76	114.0700.629	76
114.0658.333	63	114.0715.513	73	114.0715.513	73
114.0658.334	63	114.0715.514	73	114.0715.514	73
114.0658.417	66	114.0715.515	73	114.0715.515	73
114.0658.418	66	114.0715.518	63	114.0715.518	63
114.0658.419	66	114.0715.519	65	114.0715.519	65
114.0658.493	64	114.0715.520	65	114.0715.520	65
114.0658.494	64	114.0715.521	67	114.0715.521	67
114.0658.495	64	114.0715.522	67	114.0715.522	67
114.0658.496	64	114.0723.957	75	114.0723.957	75
114.0658.496	64	114.0723.958	75	114.0723.958	75
114.0658.497	64	114.0723.961	75	114.0723.961	75
114.0658.498	64	114.0723.965	77	114.0723.965	77

115.0028.205	172	115.0623.146	164	115.0623.146	164
115.0028.208	172	115.0623.147	164	115.0623.147	164
115.0060.360	172	115.0625.188	151	115.0625.188	151
115.0347.111	165	115.0625.190	151	115.0625.190	151
115.0347.142	165	115.0625.489	141	115.0625.489	141
115.0470.654	165	115.0625.523	141	115.0625.523	141
115.0470.655	165	115.0625.525	141	115.0625.525	141
115.0470.658	165	115.0625.527	141	115.0625.527	141
115.0470.659	165	115.0626.019	166	115.0626.019	166
115.0470.661	165	115.0626.020	166	115.0626.020	166
115.0470.665	165	115.0626.022	166	115.0626.022	166
115.0470.666	165	115.0626.024	166	115.0626.024	166
115.0470.669	165	115.0626.026	166	115.0626.026	166
115.0470.670	165	115.0626.028	166	115.0626.028	166
115.0470.675	165	115.0626.053	167	115.0626.053	167
115.0521.435	143	115.0626.055	167	115.0626.055	167
		115.0626.057	167	115.0626.057	167
		115.0626.081	167	115.0626.081	167
		115.0626.083	167	115.0626.083	167
		115.0626.084	167	115.0626.084	167
		115.0626.085	166	115.0626.085	166
		115.0627.523	163	115.0627.523	163

FRANKE

Franke GmbH

Mumpferfährstraße 70
79713 Bad Säckingen
Deutschland
Telefon +49 (0)7761 52-500
www.franke.com

Eesti
www.franke.ee/ks

