

FRANKE

A woman with dark hair, wearing a light-colored button-down shirt and grey trousers, is smiling as she prepares a salad in a glass bowl. She is using two wooden salad tongs. In the foreground, a modern, sleek, stainless steel Franke faucet is prominently displayed, curving over a dark sink. The background shows a modern kitchen with dark cabinetry and a countertop with various kitchen items.

**TOOTE
KATALOOG**
2025 • 2026

Suurepärane etendus väärrib suurepäraast lava



Kampaania video vaatamiseks
skannige

ELAMUS SINU KODUS

FRANKE

KATALOOG

2025 • 2026

SEERIAD

- 16 Mythos
- 18 Maris
- 20 Smart

TOOTEKATEGOORIAD

- 24 Uudised**
- 28 Valamud**
- 28 Roostevaba teras
- 56 Fragranit
- 90 Tektonit
- 96 Keraamilised

- 102 Altpoolt monteeritavad valamud**
- 106 Roostevaba teras
- 122 Fragranit
- 130 Tasapinnaline
- 134 Keraamilised

- 138 Segistid**
- 142 Filtriga segistid
- 146 Roostevaba teras
- 160 Kroomitud ja värvilised

- 180 Sorterid**
- 182 Laiuse järgi
- 187 Lisad
- 188 Jäätmepurustajad

- 190 Valamud ja segistid lisad**

- 194 Artiklinumbrite register**





Aastatepikkune kogemus, kuid endiselt sama uudishimulik kui lapsed.

Oleme Frankes otsinud uusi lahendusi ja innovatsioone juba üle 100 aasta ning meie suhtumine pole siiani muutunud. 1911. aastal ühendasime traditsioonilise käsitöö, täppistehnika ja pideva püüdluse innovatsiooni poole – kolm põhimõtet, mis jäävad meie keskmesse.

Šveitsi täpsusega sepistatud lugu

Meie lugu sai alguse eelmise sajandi alguses väikese lehtmetsa Šveitsis Rorschachis, mille asutas Hermann Franke. Sellest ajast alates oleme avanud end maailmale ja avasime tootmisüksused kõikjal maailmas, mis viis meid köögivalamute alal ja üldise kodulahenduste liidriks.



Retsept tervislikumaks tulevikuks

Meie missioon on aidata luua jätkusuutlikum planeet, üks uuendus korraga. Alates jätkusuutlikest materjalidest kuni tõhususe optimeerimiseni ja jäätmete vähendamiseni tegutseme vastutustundlikult kogu oma äritegevuses ja väljaspool seda, et saavutada positiivne pikaajaline mõju.



Keskkonna eest hoolitsemine

Franke liitus ÜRO ülemaailmse kokkuleppega ja adopteeris ÜRO kümme põhimõtet ÜRO ülemaailmse kokkuleppe jätkusuutliku ja vastutustundliku ettevõtluse jaoks 2011. aastal ja on alates sellest ajast aru andnud oma jätkusuutlikkuse mõjude kohta. Loodame, et 2050. aastaks oleme saavutanud kogu tootmisahelas neto-nullheite taseme ja lokaalsete meetmetega oleme juba eesmärgi saavutamise teel CO2 heitmete kukkumisega 10% aastas alates 2016. Meie keskkonnateadlik suhtumine ei piirdu heitgaasidega; arendame oma tootmisprotsesse igavesti, et vähendada mõju keskkonnale ja olla eeskujuks.

Ressursid

59% elektritarbimisest 2022. aastal tuli taastuvenergiast, millest 6% tekkis Franke omanduses olevatel objektidel toodetud päikeseenergia abil.

Veetarbimine vähenes 2022. aastal 18,6%.

Franke Grupi maagaasitarbimine vähenes 2022. aastal 17,5%.

Jäätmed

75% 2022. aastal tekkinud jäätmetest taaskasutati.

Pakendamine

Franke on stürofoamist kartongile üle läinud oma graniidist ja tektoniidist valamute pakendamisel. 91% Franke pakenditest on valmistatud taaskasutatavast materjalidest.

Meie inimeste ja ühiskonna toetamine

Meie inimeste ja kogukondade tervis on sama oluline kui meie planeet. Seetõttu pakume oma ettevõttes juhtimiskoolitusi ja eesmärk on teha see 2030. aastaks kättesaadavaks igale töötajale. Samuti teeme koostööd riiklike ja rahvusvaheliste organisatsioonidega, tehes võimalusel vabatahtlikku tööd sotsiaalsete probleemide toetamiseks.

“Oleme investeerinud rohkem päikeseenergiasüsteemidesse, mis suudavad toota umbes 2 500 000 kWh aastas”

Patrik Wohlhauser, Franke CEO

Innovatsioon jätkusuutlikuks eluks

Meie keskkonnasõbralikud uuendused on loodud selleks, et võimaldada kodus puhtamat elamist ja inspireerida igapäevast heaolu.

Segistid

Roostevabast terasest mudelid on valmistatud 100% taaskasutatavast terasest. Franke Vital Segisti filtreerimissüsteem filtreerib vett otse kraanist, vähendades pudelivee vajadust. Atlas Neo Sensor vähendab vee raiskamist kuni 50% tänu Start/Stop-liikumisandurile.



Valamud

Franke valamute sarjad on jätkusuutlikud materjalide kasutuses, nagu näiteks roostevaba teras. Fragraniit ja keraamika, tagavad toote erakordse vastupidavuse ja pikaajalise kvaliteedi.

Õhupuhastid

Kõik mudelid on loodud energiatarbimise vähendamiseks ja energiatarbimise parandamiseks koos AUTO funktsiooniga. A++ klassi õhupuhastid vähendavad energiatarbimist kuni 85%. Kauakestvaid filtreid ja aktiivsõe keraamilisi filtreid saab regenereerida ja need on loodud jäätmete veelgi vähendamiseks võrreldes tavaliste ühekordselt kasutatavate söefiltritega.



Pliidiplaat õhupuhastiga

Meie õhupuhastid pakuvad maksimaalset energiatõhusust. Näiteks ülivõimas Mythos 2gether õhupuhasti on tänu oma harjadeta mootorile hinnatud parima võimaliku energiatõhususe klassiga A+++.

Ahjud ja mikrolaineahjud

A ja A+ energiaklass, mis pakub eri funktsiooni võimaldades ühe tsükliga erinevaid toite valmistada ja aurupuhastusfunktsiooni, mis võimaldab puhastada kahjulikke kemikaale kasutamata.



Külmkappid

Disainitud külma tsooni kambritega, et toit püsiks kauem värskena. No Frost tehnoloogia, mis aitab vältida sulatamist ja puhkusežimiga, mis võimaldab hoida sügavkülmit aktiivseks ka siis, kui jaheosa ei ole.

FRANKE



HOME SOLUTIONS

Lahendused, mis töötavad

Meie köögid on kohad, kus elame: teeme seal süüa, sööme, veedame seal koos aega, sagedamini kui mitte teeme seal neid kõiki kolme korraga. Jälgime põhjalikult oma köögis toimuvaid liikumisi ja töötasime välja lihtsate seadmete asemel korralikud kodulahendused. Kõik meie üksikud tooted sulavad kokku funktsionaalseteks süsteemideks, mille eesmärk on hõlbustada teie elu ja rõõmustada teie silma tänu ideaalselt sobivatele värvidele, disainidele ja kombinatsioonidele. Kui need kõik kokku panna, on iga hetke lihtsam nautida.

Toidu valmistamise alad

Kraanid, valamud ja jäätmekäitlussüsteemid.

Auhinnatud, nutikad ja keskkonnasõbralikud kraanid, mida ideaalselt täiustavad elegantsed, mahukad kausid, mida saab varustada tarvikute või muude nutikate tööriistadega, et teil oleks kõik vajalik alati käepärast. Kõik parimatest, vastupidavamatest ja hügieenilisematest materjalidest, näiteks roostevaba teras või meie eksklusiivsest fragraniidist.

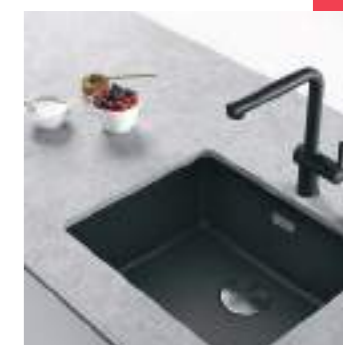

Kubud

Seina-, lae-, sisseehitatud, saarekubud.

Igal köögil on omad spetsiifilised vajadused, seetõttu lõime kubude valiku, mis üllatab teid tehnoloogia, tõhususe, valgustuse ja kauni disainiga. Avastage saadaolevad värvid, kujundid ja eritehnoloogiad alates sisseehitatud ekraanidest kuni õhupuhasüsteemideni.

Seadmed

Ahjud, mikrolaineahjud, pliidiplaadid, kohvimasinad, masinad, mikrolaineahjud, külmikud ja nõudepesumasinad.

Oma seadmeid disainides lähtume teie rutiinidest, et saaksime pakkuda funktsionaalseid lahendusi, mis on lihtsasti kasutatavad, nutikate funktsioonidega ja silmale ilusad.



Kogege meie uut Näiteruumi

Tere tulemast Franke Aarburg Näitusesaali, koht avastamiseks.

Võti on olnud tuua Franke uus positsioneerimine ellu viia läbi Aarburgi näiteruumi kontsepti, aga ka kõigis ruumides, kus rakendatakse ja kohandatakse uut brändi stiilijuhtimist. Väljapanekul on kasutatud primaarseid kui ka lai valik sekundaarseid värve, luues elava, värske ja kaasaegse disainikombinatsiooni. Tipphetkedeks on meie tootepere Mythos, Maris ja Smart, kes esindavad parimal moel Franket süsteemipakkujana. Näidissaalis on tähelepanu pööratud ka inimestele ja nende heaolule avatud ja selgelt arusaadavate demonstratsiooninurkadega mõnuses loodusliku materjali keskkonnas.

Franke uuendused tuuakse esindussaali ülikvaliteetse välimuse, tooni ja tunnetusega, mis tõstab brändi ja toodete kogemuse täiel määral.

Aarburg Näiteruum

Franke-Strasse 2
4663 Aarburg
Swiss
Tel: +41 62 787 31 31



Skännige,
nägemaks
Aarburg
näiteruumi

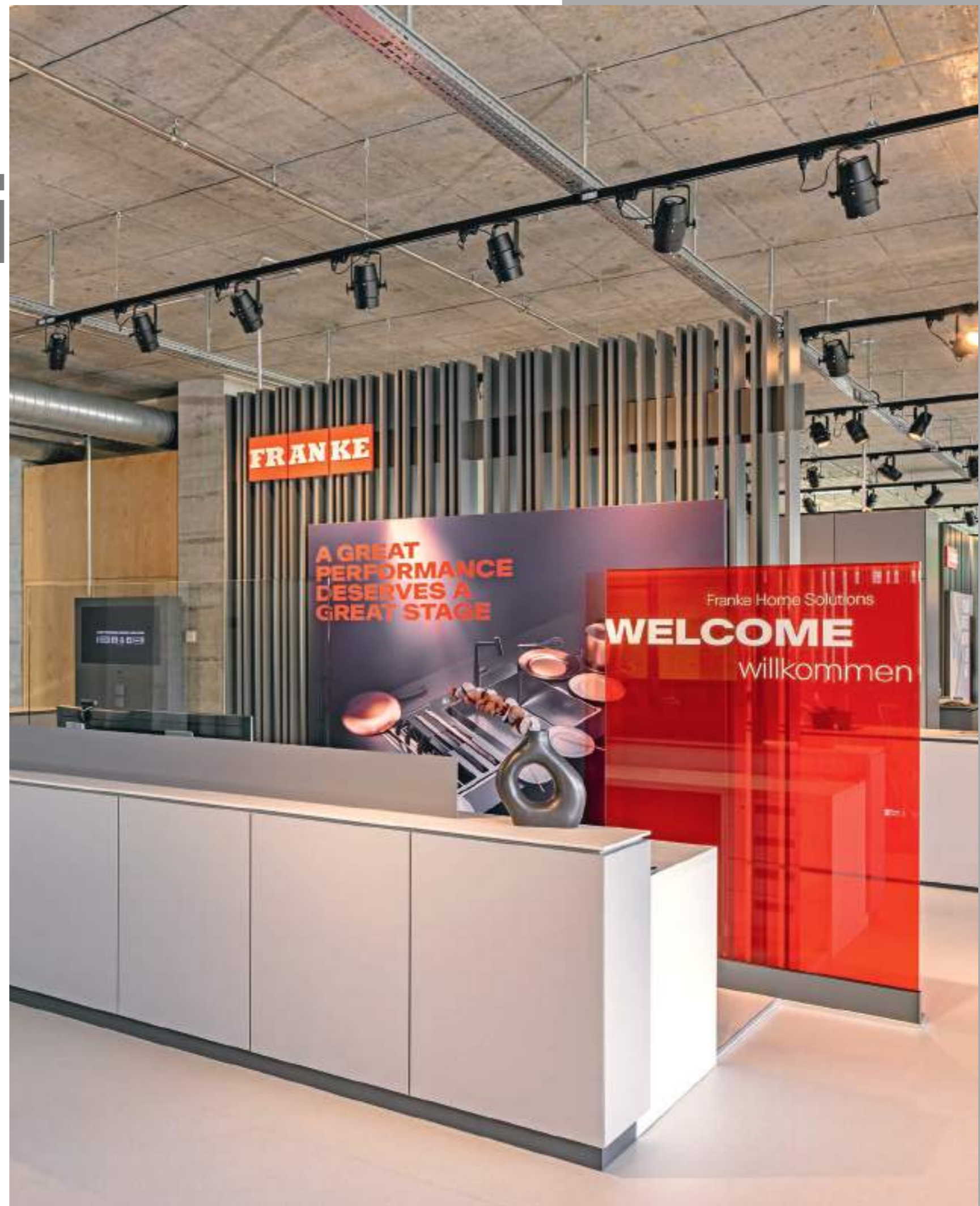

Inspiratsioonid

Miski ei asenda kodu. Ja kahte ühesugust kodu pole olemas. See, kuidas me oma pesa kalliks peame, on täpselt sama ainulaadne kui meie – igaühel on erinevad maitset, eelistused ja vajadused. Et aidata teil saada inspiratsiooni ja luua oma unistuste köögikeskkond ning seda igapäevaselt nautida, töötasime välja kolm erinevat tooteperekonda.

Mythos

Kirg parima vastu

Meie kõige esmaklassilisem valik. Tehnoloogia kohtub disainiga, samas kui ka kõige väiksematele detailidele on tähelepanu pööratud. See seeria seab oma eesmärgi kõrgeimale tasemele, ühendades endas funktsionaalsuse ja ilu.

Maris

Perekond köögis

Perest inspireeritud seeria. Hubane ja funktsionaalne pererahva koosviibimise südantsoojendava kogemuse nautimiseks. Marise filosoofia on lihtne: võtke kõik vastu ja igal ajal omatehtud õhtusöögi uhkuse ja rõõmuga.

Smart

Otse selle juurde, mis on oluline

Kõige lihtsamad asjad toimivad kõige paremini. Oma täiuslikkuses hädavajalik, et jõuda kõige olulisema juurde: teie kööki rõõmu toomine. Seeria, mis on loodud täitma mis tahes vajadusi ja eelistusi.

See, milline teie köök välja näeb, on teie otsustada, kuid olenemata sellest, kuidas te rõõmu oma koju toote, võite meie peale loota.





Valamud: Mythos Masterpiece -
BXM 110-50
Segisti: Eos Neo
Seebidosaatorid: Atlas

Mythos



Induktsioonpliidite ja õhupuhastite kombinatsioonid:
Mythos 2gether - FMY 839 HI 2.0



Ahjud: Mythos - FMY 99 PXS
Kohvimasin: Mythos - FMY 45 CM XS
Veinikapp: Mythos - FMY 24 WCR XS
Soojendussahtel: Mythos - FMY 14 DRW XS



Valamud: Maris Black Collection - MRG 610-72 TL
Segisti: Active - väljatõmmatava otsikuga
Seebidosaator: Active

Maris



Induktsioonpliidite ja õhupuhasdite kombinatsioonid: Maris 2gether - FMA 839 HI



Ahjud: Maris - FMA 97 P XS
Mikrolaineahi: Maris - FMA 45 MW XS





Valamud: Sirius - S2D 611 - 100
Segisti: Lina

Smart



Õhupuhasti: Smart Deco - FSMD 508 YL
Induktsioonpliidiplaadid: Smart - FSM 804 I B BK
Ahjud: Smart - FSM 97 P XS
Mikrolaineahi: Smart - FSM 45 MW XS

Näita, millest sa tehtud oled!

Läikiv või matt, sile või kivitaoline, eriti tugev või ülitrendikas. Teie köök võib teie kohta palju rääkida, nii et iga detail loeb. Et pakkuda teile võimalust luua oma täiuslik köök, on meie materjalivalik loodud nii, et see meeldiks igale maitsele, sobiks iga stiiliga ja seisaks vastu kõikidele püüdlustele. Avastage iga materjali täpselt väljatöötatud iseloom ja ainulaadsed eelised, et valida see, mis vastab teie vajadustele kõige paremini ja mis teile kõige rohkem meeldib.



Fragranit

Erakordselt tugev materjal, mis on väga vastupidav põletustele, mõlkidele ja plekkidele. See on ainulaadne materjal, mille on valmistanud Franke, peene läikega, mis on katsudes soe tänu peaaegu 80% kvartsliaivale. Pind on peene tekstuuriga, mis tagab kõrged hügieenistandardid.

Tektoniit

Kuumus, šokk ja löök ei hirmuta meie Tektoniiti. Tugevus koos ainulaadse disainivabadusega muudab Tektoniit valamud ülimalt valikuks töökasse ja stiilsesse kööki. Uus tehnoloogia kujutab endast hiiglaslikku hüpet sünteetiliste materjalide osas, võimaldades samal ajal põnevaid minimalistlike kujundusi uutes trendikas värvides.



F-Inox Tehnoloogia

Eksklusiivne Franke kate, mis suudab rühmitada veemolekule ja võimaldab teil oma valamut kuivatada ilma rõngjate plekkideta. Vett hülgav ja kriimustuskindel, see futuristlik kate ei karda ka kuni 350° kuumust. Tõeline ja kauakestev iluvalem, mida saate hinnata meie Masterpiece'i perekonnalt.



Roostevaba teras

Ükskõik, kas eelistate poleeritud viimistluse peegeldavaid omadusi, siidise viimistluse peenemat välimust või harjatud viimistlus, mis annab mati läike. Igal juhul on teie jaoks roostevabast terasest lahendus. Kõik Franke roostevabast terasest tooted on valmistatud esmaklassilisest kroomnikelterasest, mis näeb välja vapustav ning on väga vastupidav määrdumisele, roostele ja korrosioonile – lisaks ei purune, ei tuhmu, helvestu ega purune. Kui roostevaba teras on köögis üks populaarsemaid materjale, on sellel mõjuv põhjus.

PVD kate

PVD, mis tähendab "füüsiline aurustamine-sadestamine", on kattetehnoloogia, mis muudab segistid veelgi vastupidavamaks hõõrdumisele, kriimustustele ja korrosioonile ning pakub ka erakordseid esteetilisi omadusi. PDV-kattega töödeldud segisti peab isegi UV-kiirgusele vastu ja muudab sõrmejäljed kiires köögis vähem nähtavaks. Saadaval erineva viimistlusega, kusjuures kroom on endiselt kõige populaarsem. Nüüd saadaval hulgaliselt muid suurepäraseid viimistlusi. Tugevast roostevabast terasest, mis ühendab ilu vastupidavusega, messingist kuni tööstusliku musta, vase ja kullani, leiab teie jaoks midagi, mis sobib igasse köögistiili.



Fraceram

Keraamilistel valamutel on sile, veekindel pind, mis talub kergesti kuumust, määrdumist, lööke ja talub kergesti kõiki tavalisi kodukeemiatooteid. Keraamilised valamud on olnud populaarne valik juba aastaid ja loovad klassikalise kombinatsiooni erinevate tööpindadega nagu puit, klaas ja graniit.



Teie vajaduste rahuldamine on alati olnud meie pärand.

Ilus ja loodud päriselus kasutamiseks. Teras esindab meie köögiideaali.

Franke toodete puhas kvaliteet on näha ja tunda. Kasutame AISI 304 18/10 terast, mida toodetakse Itaalias ja Euroopas: valik, mis peegeldab meie pühendumust kvaliteedile, mis on üks meie peamisi prioriteete meie 100-aastase ajaloo jooksul. Tugev ja vastupidav, säilitab see aja jooksul oma sära, muutes selle eluruumide määravaks tunnuseks, kuhu see paigaldatakse. Selle suurepärase tehnilised omadused tagavad, et see on alati nõutud ja kõrgelt hinnatud kõrgköögisektori professionaalide seas: lisaks on roostevaba teras äärmiselt hügieeniline materjal, mida on lihtne puhastada ja taaskasutada. Esteetiliselt meeldiv ja funktsionaalne kasutada: roostevaba teras esindab tõesti kvaliteeti sära-vas soomuses.

Klienditeenindus ja Tehniline abi

Valamute ja segistitega seotud probleemidest teavitamiseks esimese 24 kuu jooksul pärast ostmist võtke ühendust hooldusega.

Teenindus

Eliser OÜ

Mustamäe tee 24 (sissepääs maja tagant hoovist Forelli tänava poolt)

EE10621 Tallinn, Estonia

E-R 9:00 - 17.00

+372 6650090

hooldus@eliser.ee

NEW

Fragranite Slate Grey valamud ja segistid

Elavda oma kööki värvide abil

Värvide harmoonia

Slate Grey valamute, kraanikausside ja seebidosatorite valik on meisterlik ning peent elegantsi õhkav värvikoordineeritus. See ühtne värvipalett loob sujuva visuaalse voolu, kus iga element täiendab üksteist täiuslikus harmoonias.

Fragranite Slate Grey on uus Franke'i värvivalik, mis täiendab sujuvalt erinevaid elustiile. See võimaldab värve kooskõlastada või kontraste omavahel kombineerida, luues silmatorkava köögiesteetika, mis peegeldab just Sind. Inspireerituna viimastest sisearhitektuuri suundumustest ja disainerite lemmikutest, võid olla kindel, et lood kvaliteetse köögikeskkonna, mida iseloomustab visadus ja elegantne harmoonia.



Igale maitsele

Uus Fragranite Slate Grey esindab sooja, kuid intensiivset värvivalikut. See loob kontrasti valgete, heledamate hallide ja heledate puidust tööpinnadekooridega, pakkudes samas alternatiivi ka neile, kellele ei meeldi köögis domineerivad mustad elemendid. Saadaval kõigi Franke Fragranite valamute ja kraanikausside puhul.

Määravad on üksikasjad

Kerge tekstuur, mis pakub loomulikku välimust ja on puudutades meeldiv – see mitmekülgne lahendus on lihtsalt kombineeritav metallpindade ja köögimööbliga, sobides erinevate köögistiilidega, alates tööstuslikust kuni taluköögin.

Loodud kogu eluks

Kauakestev ja vastupidav disain võimaldab igapäevast pidevat kasutamist ilma kriimustuste, värvimuutuse või kuumakahjustuseta. Vähe sellest, lihtsalt puhastatav pind tagab maksimaalse igapäevase hügieeni, olles ühtlasi võimalikult mugav.



Mythos



MTG 611
63. lk.

Urban



UBG 611-100
75. lk.

Basis



BFG 651
81. lk.

Centro



CNG 611-86
79. lk.

Maris



MRG 610-72A
69. lk.



UBG 611-78
75. lk.



BFG 651-78
81. lk.



CNG 611-78
79. lk.



MRG 610-52A
71. lk.



UBG 611-78XL
76. lk.



BFG 611-86
81. lk.



CNG 611-62
79. lk.



MRG 610-37A
73. lk.



UBG 611-62
77. lk.



BFG 611-78
83. lk.



STG 611-86
STG 611-78
85. lk.

Active L



Active L
165. lk.



UBG 610-56
77. lk.



BFG 611-62
83. lk.

Seebidosatorid



Active Plus
178. lk.



BFG 620
83. lk.

Ronda



ROG 610-41
87. lk.

NEW

Maris Quiet

See unistab suurelt, kuid on kõrvale meeldivalt sosistav.



Eriti lai ja ülivaike

Meie uusim ja eriti lai roostevabast terasest kraanikauss Maris Quiet Bowl on loodud vaikust silmas pidades, pakkudes toiduvalmistamisele ja kujutlusvõimele vajalikku avarust.



MQX 110-82
860 x 460 mm
111. lk.



MQX 110-50
540 x 460 mm
111. lk.

Uued mudelid roostevabast terasest valamute majandusklassis



SKN 611-78/44
SKL 611-78/44
780 x 435 mm
51. lk.



SKN 611-86/44
860 x 435 mm
51. lk.



SKN 611-62/44
620 x 435 mm
52. lk.



SKN 610-37/44
455 x 435 mm
52. lk.



SKX 620-86
860 x 500 mm
53. lk.



SKX 621
1160 x 500 mm
53. lk.



SKX 651-95-E
945 x 510 mm
53. lk.



SRX 110-50
541 x 441 mm
120. lk.

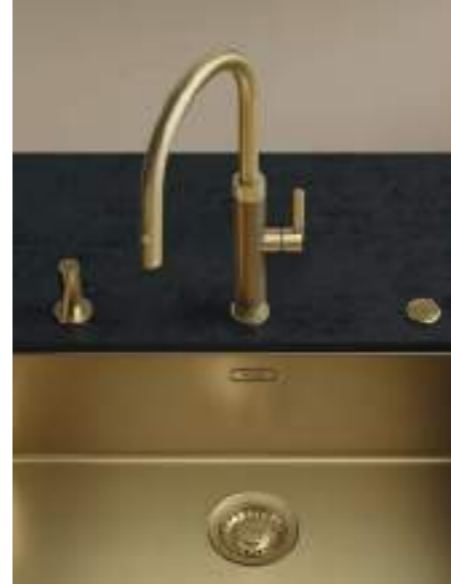

Mythos Masterpiece



Roostevabast terasest
147. lk.



Antratsiit
147. lk.



Bronzas toni
147. lk.



Šampanjakuldne
147. lk.

Smart Glenda



Roostevabast terasest
159. lk.



Lina L



5 värvides
175. lk.

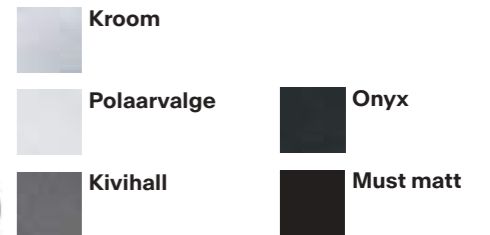

Lina U



2 värvides
174. lk.

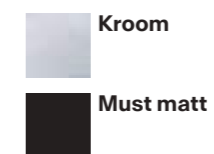

Roostevabast teraseest

valamud



32
34
36
38
40
44
48
49
50
54
55
56
57

Ülevaade
Mythos Masterpiece
Mythos
Box Centre
Franke Box
Maris
Argos
Bell
Spark
Logica Line
Rapid
Antea
Ronda



Roostevabast

Aluskapp
80-90 cm



MYX 210-70
36. lk.



MYX 210-55
37. lk.



BWX 220-54-27 A
39. lk.



BXX 210/110-68
40. lk.

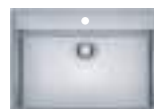

MRX 210-70TL
45. lk.



MRX 210-70
46. lk.



SKX 620-86
53. lk.



SKX 621
53. lk.

Aluskapp
60 cm



BXM 210/110-50
35. lk.



MYX 210-50
35. lk.



BXX 210/110-54
41. lk.



BXX 210/110-50
41. lk.

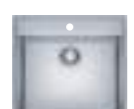

MRX 210-50TL
45. lk.



MRX 210-50
47. lk.



SKX 651
50. lk.



AZN 651
56. lk.



RPX 611-86XL
53. lk.



LLX 611
54. lk.

Aluskapp
50 cm



MYX 210-45
37. lk.



BXX 210/110-45
41. lk.



MRX 210-40TL
45. lk.



MRX 210-45
47. lk.



MRX 210-40
47. lk.



BCX 610-51
49. lk.



EFX 614-78
EFN 614-78
56. lk.

teraseest valamud

Aluskapp
45 cm



BXM 210/110-40
35. lk.



AGX 211-78
48. lk.



AGX 211-62
48. lk.



BXX 210/110-40
42. lk.



SKX 611-86
50. lk.



SKX 611-79
51. lk.



SKN 611-86/44
51. lk.



SKN 611-78/44
SKL 611-78/44
51. lk.



SKX 611-63,
SKN 611-63
52. lk.



AZN 611-62
56. lk.



SKN 611-62/44
52. lk.



SKN 610-37/44
52. lk.



RON 610-39
ROL 610-39
57. lk.



ROX 6101/110-38
57. lk.

Aluskapp
40-30 cm



BXX 210/110-34
43. lk.



BXX 210/110-16
43. lk.



MRX 210-34
47. lk.

Nurgavalamud



SKX 651-95E
53. lk.

Mythos Masterpiece



MYTHOS



BXM 210/110-50

Aluskapp: 60 cm
Mõõdud: 540 x 450 mm
Väljalõige: 510 x 420 mm (R = 10 mm)
Kausi mõõtmed: 500 /410 /200 mm
Paigaldamine: SlimTop, tasapinnaline või altpoolt
Materjal: F-Inox roostevaba teras
Ventil: eksentriline või manuaalne 3½" ventiil
Ventili juhtimine: Ümmargune nupp (vajab 35 mm ava tööpinna jaoks) või käsitsi avamine
Ülevool: katteplaadiga ülevool
Tööpind: min paksus 12 mm



Lisatarvikud, mis kuuluvad komplekti: Tavaline metallrest valamule, valamu värvid (A1, G1 või C1)

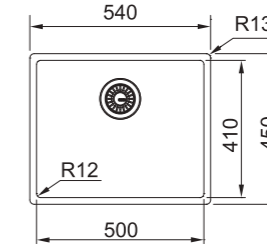

Nupuga juhitud eksentriklapiga valamu.



Antratsiit*
127.0650.363 *
1293.- €

Šampanjakuldne*
127.0662.540 *
1293.- €

Vask*
127.0662.642 *
1293.- €

Valamu käsitsi ventiiliga, mida saab tõsta/langutada manuaalselt



Antratsiit*
127.0672.129 *
1151.- €

Šampanjakuldne*
127.0674.362 *
1151.- €

Vask*
127.0674.363 *
1151.- €

* - Küsi saadavust oma Franke partnerilt

Lisad

Antratsiit	1 112.0676.854 Plastikust lõikepind 240 x 429 x 15 mm 169.- €	A1 112.0655.470 Tavaline metallrest kraanikausile Antratsiit 491 x 401 mm (50 cm valamud) 194.- €	A2 112.0655.431 Tavaline metallrest kraanikausile Antratsiit 391 x 401 mm (40 cm valamud) 155.- €	A3 112.0655.239 Nõrutuskauss- roostevaba teras Antratsiit plastik käepidemega 157 x 429 x 54 mm 162.- €	A4 112.0655.342 Rullmatt paindub Antratsiit 468 x 440 mm 291.- €
Šampanjakuldne	1 112.0676.854 Plastikust lõikepind 240 x 429 x 15 mm 169.- €	G1 112.0655.471 Tavaline metallrest kraanikausile Šam- panjakuldne 491 x 401 mm (50 cm valamud) 194.- €	G2 112.0655.433 Tavaline metallrest kraanikausile Šam- panjakuldne 391 x 401 mm (40 cm valamud) 155.- €	G3 112.0655.240 Nõrutuskauss- roostevaba teras Šampanjakuldne plastik käepidemega 157 x 429 x 54 mm 162.- €	G4 112.0655.343 Rullmatt paindub Šampanjakuldne 468 x 440 mm 291.- €
Vask	1 112.0676.854 Plastikust lõikepind 240 x 429 x 15 mm 169.- €	C1 112.0655.472 Tavaline metallrest kraanikausile vask 491 x 401 mm (50 cm valamud) 194.- €	C2 112.0655.468 Tavaline metallrest kraanikausile vask 391 x 401 mm (40 cm valamud) 155.- €	C3 112.0655.341 Nõrutuskauss- roostevaba teras vask plastik käep- idemega 157 x 429 x 54 mm 162.- €	C4 112.0655.344 Rullmatt paindub vask 468 x 440 mm 291.- €

Ühilduvad tooted



Mythos Masterpiece segistid rohkem 147. lk.



Atlas Neo segistid rohkem 154. lk.



Eos Neo segistid rohkem 157. lk.



Atlas Neo seebidosaatid rohkem 178. lk.

MYTHOS



BXM 210/110-40

Aluskapp: 45 cm
Mõõdud: 440 x 450 mm
Väljalõige: 410 x 420 mm (R = 10 mm)
Kausi mõõtmed: 400 /410 /200 mm
Paigaldamine: SlimTop, tasapinnaline või altpoolt
Materjal: F-Inox roostevaba teras
Ventil: eksentriline või manuaalne 3½" ventiil
Ventili juhtimine: Ümmargune nupp (vajab 35 mm ava tööpinna jaoks) või käsitsi avamine
Ülevool: katteplaadiga ülevool
Tööpind: min paksus 12 mm



Lisatarvikud, mis kuuluvad komplekti: Tavaline metallrest valamule, valamu värvid (A2, G2 või C2)

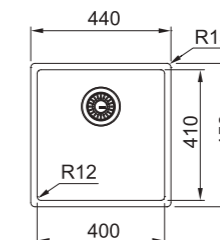

Nupuga juhitud eksentriklapiga valamu.



Antratsiit*
127.0650.362 *
1206.- €

Šampanjakuldne*
127.0662.648 *
1206.- €

Vask*
127.0662.649 *
1206.- €

Valamu käsitsi ventiiliga, mida saab tõsta/langutada manuaalselt



Antratsiit*
127.0674.537 *
1065.- €

Šampanjakuldne*
127.0674.582 *
1065.- €

Vask*
127.0674.583 *
1065.- €

* - Küsi saadavust oma Franke partnerilt



Lisad

- | | | | | |
|---|--|--|--|--|
| 1 | 2 | 3 | 4 | 5 |
| | | | | |
| 112.0591.082
Lõikelaud kivipaber kiltkivi
180 x 412 mm
115.- € | 112.0591.081
Rullmatt painduv
252 x 424 mm
65.- € | 112.0602.288
Rv Mobiilne nõruti plastik
raamis 298 x 412 mm
104.- € | 112.0659.398
Roostevabast terasest
nõrutuskauss plastkäepide-
metega
159 x 416 x 54 mm
63.- € | 115.0529.207
Eos Neo U roostevabast
terasest segistid
325.- € |

MYTHOS



Mudel: **MYX 210-70**
Aluskapp: **80 cm**
Mõõdud: **712 x 412 mm**
Väljalõige: **706 x 406 mm (R = 28 mm)**
Kausi mõõtmed: **700 /400 /200 mm**
Paigaldamine: **Slim Top või tasapinnaline**
Materjal: **roostevaba teras poleeritud**
Ventiil: **integreeritud ventiil**
Ventiili juhtimine: **Vajutusnupp ümmargune roostevaba teras (vajaliku tööpinna jaoks on vaja 35 mm auku)**
Ventiil kaas: **komplektis ümmarguse metallkattega**
Ülevool: **katteplaadiga ülevool**
Tööpind: **min paksus 12 mm**

MYX 210-70
127.0603.546
852.- €

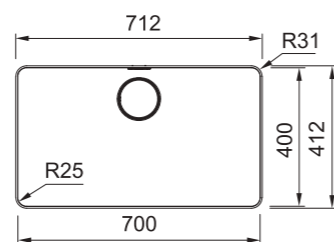

MYTHOS

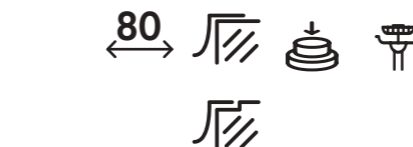

Mudel: **MYX 210-55**
Aluskapp: **80 cm**
Mõõdud: **562 x 412 mm**
Väljalõige: **556 x 406 mm (R = 28 mm)**
Kausi mõõtmed: **550 /400 /200 mm**
Paigaldamine: **Slim Top või tasapinnaline**
Materjal: **roostevaba teras poleeritud**
Ventiil: **integreeritud ventiil**
Ventiili juhtimine: **Vajutusnupp ümmargune roostevaba teras (vajaliku tööpinna jaoks on vaja 35 mm auku)**
Ventiil kaas: **komplektis ümmarguse metallkattega**
Ülevool: **katteplaadiga ülevool**
Tööpind: **min paksus 12 mm**

MYX 210-55
127.0625.054
763.- €

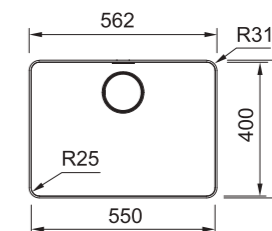

MYTHOS

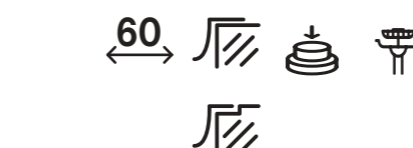

Mudel: **MYX 210-50**
Aluskapp: **60 cm**
Mõõdud: **512 x 412 mm**
Väljalõige: **506 x 406 mm (R = 28 mm)**
Kausi mõõtmed: **500 /400 /200 mm**
Paigaldamine: **Slim Top või tasapinnaline**
Materjal: **roostevaba teras poleeritud**
Ventiil: **integreeritud ventiil**
Ventiili juhtimine: **Vajutusnupp ümmargune roostevaba teras (vajaliku tööpinna jaoks on vaja 35 mm auku)**
Ventiil kaas: **komplektis ümmarguse metallkattega**
Ülevool: **katteplaadiga ülevool**
Tööpind: **min paksus 12 mm**

MYX 210-50
127.0603.544
735.- €

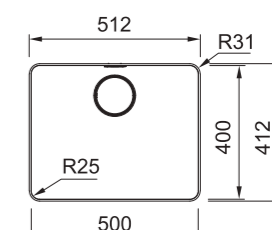

MYTHOS

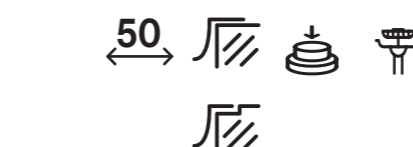

Mudel: **MYX 210-45**
Aluskapp: **50 cm**
Mõõdud: **462 x 412 mm**
Väljalõige: **456 x 406 mm (R = 28 mm)**
Kausi mõõtmed: **450 /400 /200 mm**
Paigaldamine: **Slim Top või tasapinnaline**
Materjal: **roostevaba teras poleeritud**
Ventiil: **integreeritud ventiil**
Ventiili juhtimine: **Vajutusnupp ümmargune roostevaba teras (vajaliku tööpinna jaoks on vaja 35 mm auku)**
Ventiil kaas: **komplektis ümmarguse metallkattega**
Ülevool: **katteplaadiga ülevool**
Tööpind: **min paksus 12 mm**

MYX 210-45
127.0603.543
706.- €

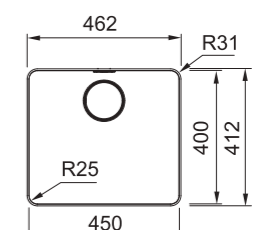

Enne tööpinna paigaldamist peab järgmistel mudelitel olema ülevooluploki väljalõige:
MYX 210-70, MYX 210-55, MYX 210-50, MYX 210-45

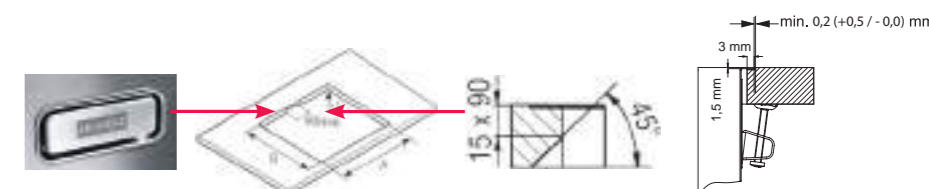

Box Centre



MYTHOS



Mudel: **BWX 220-54-27 A**
 Aluskapp: **90 cm**
 Mõõdud: **860 x 510 mm**
 Väljalõige: **840 x 490 mm (R = 10 mm)**
 Kausi mõõtmed: **540 /410 /200 + 270 /480 /200 mm**
 Paigaldamine: **Slim Top või tasapinnaline**
 Materjal: **roostevaba teras poleeritud**
 Ventil: **3½" ventil**
 Ventili juhtimine: **Vajutusnupp ümmargune roostevaba teras**
 Ülevool: **katteplaadiga ülevool**
 Segisti auk: **segisti ja nupu jaoks 2x 35 mm auk**
 Tööpind: **min paksus 12 mm**
 Sisaldub komplektis: **7 lisa**

Suur kauss paremal
 **BWX 220-54-27 A**
 127.0558.824
 1570.- €

Suur kauss vasakul
 **BWX 220-54-27 A**
 127.0558.826
 1570.- €



Toode koosneb kahest pakendist (tootenumber all):
 - Suur kauss paremal
 127.0558.824 = 127.0543.037 + 112.0544.226
 - Suur kauss vasakul
 127.0558.826 = 127.0543.036 + 112.0544.226

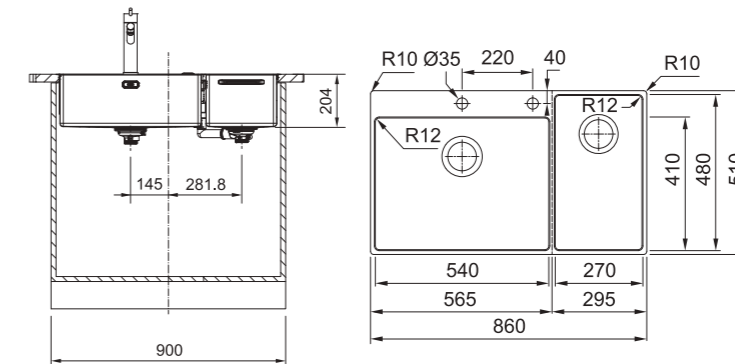

Lisatarvikud, mis kuuluvad komplekti





Lisad

- | | | | |
|--|--|--|--|
| 1 | 2 | 3 | 4 |
| | | | |
| 112.0080.355
Rollmatt painduv
468 x 440 mm
86.- € | 112.0204.360
Rv Mobiiline nõruti plastik
raamis 326 x 440 x 23 mm
124.- € | 112.0394.981
Roostevabast terasest
nõrutuskauss plastkäepide-
metega
429 x 156 mm
110.- € | 112.0619.946
Andy Chef - tarvikute
komplekt
408 x 133 x 200 mm
471.- € |

MARIS

- 1
- 2
- 3
- 4



Mudel: **BXX 210/110-68**
Aluskapp: **80 cm**
Mõõdud: **725 x 450 mm**
Väljalõige: **695 x 420 mm (R = 10 mm)**
Kausi mõõtmed: **685 / 410 / 200 mm**
Paigaldamine: **SlimTop, tasapinnaline või altpoolt**
Materjal: **roostevaba teras poleeritud**
Ventiiil: **integreeritud või 3½" ventiil**
Ventiiili juhtimine: **Vajutusnupp ümmargune roostevaba teras**

Nupu kasutamiseks on vaja 35 mm auku
Ülevool: **katteplaadiga ülevool**
Tööpind: **min paksus 12 mm**

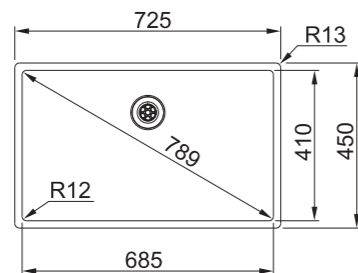

Tasapinnalise paigalduse süvend
peab olema 1,1 mm
1,1 mm | 1,1 mm

Valamu põhjaga integreeritud ekstsentrilapiga valamu, mida juhitakse nupuga.

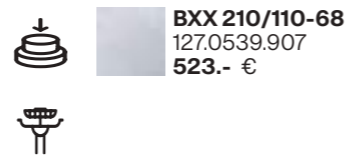

Valamu käsitsi ventiiliga, mida saab tõsta/langetada manuaalselt. Täienduste hulgas on ka jäätmepurustusmasinad.

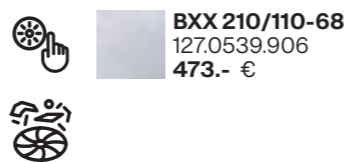

BXX 210/110-68
127.0539.907
523.- €

BXX 210/110-68
127.0539.906
473.- €

MARIS

- 1
- 2
- 3
- 4



Mudel: **BXX 210/110-45**
Aluskapp: **50 cm**
Altpoolt monteeritav aluskapp: **60 cm**
Mõõdud: **490 x 450 mm**
Väljalõige: **460 x 420 mm (R = 10 mm)**
Kausi mõõtmed: **450 / 410 / 200 mm**
Paigaldamine: **SlimTop, tasapinnaline või altpoolt**
Materjal: **roostevaba teras poleeritud**
Ventiiil: **integreeritud või 3½" ventiil**
Ventiiili juhtimine: **Vajutusnupp ümmargune roostevaba teras**

Nupu kasutamiseks on vaja 35 mm auku
Ülevool: **katteplaadiga ülevool**
Tööpind: **min paksus 12 mm**



Tasapinnalise paigalduse süvend
peab olema 1,1 mm
1,1 mm | 1,1 mm

Valamu põhjaga integreeritud ekstsentrilapiga valamu, mida juhitakse nupuga.

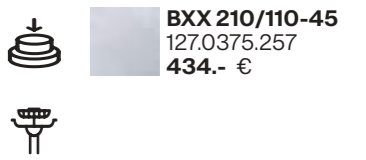

Valamu käsitsi ventiiliga, mida saab tõsta/langetada manuaalselt. Täienduste hulgas on ka jäätmepurustusmasinad.

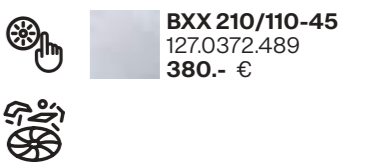

BXX 210/110-45
127.0375.257
434.- €

BXX 210/110-45
127.0372.489
380.- €

MARIS

- 1
- 2
- 3
- 4



Mudel: **BXX 210/110-50**
Aluskapp: **60 cm**
Mõõdud: **540 x 450 mm**
Väljalõige: **510 x 420 mm (R = 10 mm)**
Kausi mõõtmed: **500 / 410 / 200 mm**
Paigaldamine: **SlimTop, tasapinnaline või altpoolt**
Materjal: **roostevaba teras poleeritud**
Ventiiil: **integreeritud või 3½" ventiil**
Ventiiili juhtimine: **Vajutusnupp ümmargune roostevaba teras**

Nupu kasutamiseks on vaja 35 mm auku
Ülevool: **katteplaadiga ülevool**
Tööpind: **min paksus 12 mm**

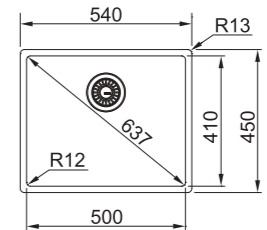

Valamu põhjaga integreeritud ekstsentrilapiga valamu, mida juhitakse nupuga.

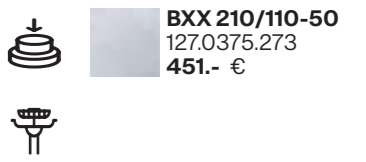

Valamu käsitsi ventiiliga, mida saab tõsta/langetada manuaalselt. Täienduste hulgas on ka jäätmepurustusmasinad.

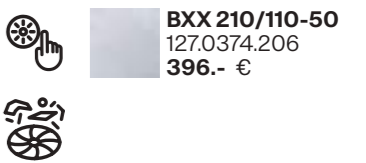

BXX 210/110-50
127.0375.273
451.- €

BXX 210/110-50
127.0374.206
396.- €

MARIS

- 1
- 2
- 3
- 4



Mudel: **BXX 210/110-54**
Aluskapp: **60 cm**
Altpoolt monteeritav aluskapp: **80 cm**
Mõõdud: **580 x 450 mm**
Väljalõige: **550 x 420 mm (R = 10 mm)**
Kausi mõõtmed: **540 / 410 / 200 mm**
Paigaldamine: **SlimTop, tasapinnaline või altpoolt**
Materjal: **roostevaba teras poleeritud**
Ventiiil: **integreeritud või 3½" ventiil**
Ventiiili juhtimine: **Vajutusnupp ümmargune roostevaba teras**

Nupu kasutamiseks on vaja 35 mm auku
Ülevool: **katteplaadiga ülevool**
Tööpind: **min paksus 12 mm**

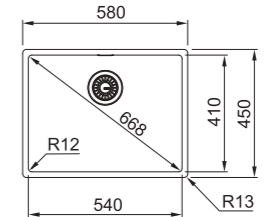

Valamu põhjaga integreeritud ekstsentrilapiga valamu, mida juhitakse nupuga.

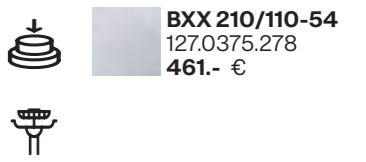

Valamu käsitsi ventiiliga, mida saab tõsta/langetada manuaalselt. Täienduste hulgas on ka jäätmepurustusmasinad.

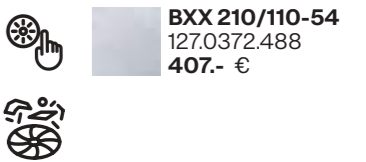

BXX 210/110-54
127.0375.278
461.- €

BXX 210/110-54
127.0372.488
407.- €



Lisad

- | | | | |
|--|---|--|--|
| 1 | 2 | 3 | 4 |
| | | | |
| 112.0080.355
Rullmatt paindub
468 x 440 mm
86.- € | 112.0204.360
Rv Mobiilne nõruti plastik
raamis 326 x 440 x 23 mm
124.- € | 112.0394.981
Roostevabast terasest
nõrutuskauss plastkäepide-
metega
429 x 156 mm
110.- € | 112.0619.946
Andy Chef - tarvikute
komplekt
408 x 133 x 200 mm
471.- € |

MARIS



- 1
- 2
- 3
- 4



Tasapinnalise paigalduse süvend
peab olema 1,1 mm
1,1 mm 1,1 mm

Mudel: BXX 210/110-40

Aluskapp: **45 cm**
Altpoolt monteeritav aluskapp: **50 cm**
Mõõdud: **440 x 450 mm**
Väljalõige: **410 x 420 mm (R = 10 mm)**
Kausi mõõtmed: **400 /410 /200 mm**
Paigaldamine: **SlimTop, tasapinnaline või altpoolt**
Materjal: **roostevaba teras poleeritud**
Ventiiil: **integreeritud või 3½" ventiiil**
Ventiiili juhtimine: **Vajutusnupp ümmargune roostevaba teras**
Nupu kasutamiseks on vaja 35 mm auku
Ülevool: **katteplaadiga ülevool**
Tööpind: **min paksus 12 mm**

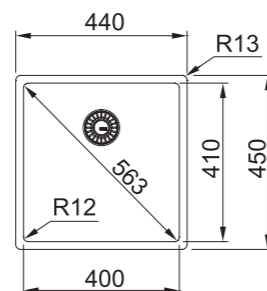

Valamu põhjaga integreeritud ekstsentrisklapiga valamu, mida juhitakse nupuga.

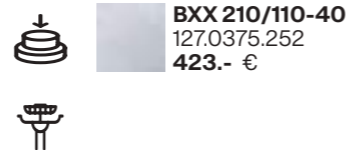

BXX 210/110-40
127.0375.252
423.- €

Valamu käsitsi ventiiiliga, mida saab tõsta/langetada manuaalselt. Täienduste hulgas on ka jäätmepurustusmasinad.

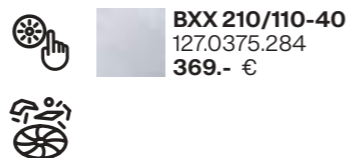

BXX 210/110-40
127.0375.284
369.- €

MARIS



- 1
- 2
- 3
- 4



Mudel: BXX 210/110-34

Aluskapp: **40 cm**
Altpoolt monteeritav aluskapp: **45 cm**
Mõõdud: **380 x 450 mm**
Väljalõige: **350 x 420 mm (R = 10 mm)**
Kausi mõõtmed: **340 /410 /200 mm**
Paigaldamine: **SlimTop, tasapinnaline või altpoolt**
Materjal: **roostevaba teras poleeritud**
Ventiiil: **integreeritud või 3½" ventiiil**
Ventiiili juhtimine: **Vajutusnupp ümmargune roostevaba teras**
Nupu kasutamiseks on vaja 35 mm auku
Ülevool: **katteplaadiga ülevool**
Tööpind: **min paksus 12 mm**

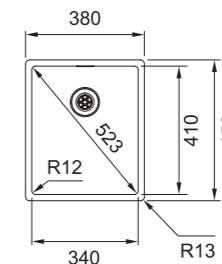

Valamu põhjaga integreeritud ekstsentrisklapiga valamu, mida juhitakse nupuga.

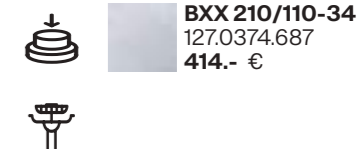

BXX 210/110-34
127.0374.687
414.- €

Valamu käsitsi ventiiiliga, mida saab tõsta/langetada manuaalselt. Täienduste hulgas on ka jäätmepurustusmasinad.

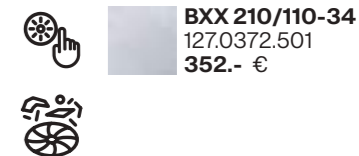

BXX 210/110-34
127.0372.501
352.- €

MARIS



- 1
- 3
- 4



Tasapinnalise paigalduse süvend
peab olema 1,1 mm
1,1 mm 1,1 mm

Mudel: BXX 210/110-16

Aluskapp: **30 cm**
Mõõdud: **200 x 450 mm**
Väljalõige: **170 x 420 mm (R = 10 mm)**
Kausi mõõtmed: **160 /410 /200 mm**
Paigaldamine: **altpoolt monteeritav**
Materjal: **roostevaba teras poleeritud**
Ventiiil: **integreeritud ventiiil**
Ventiiili juhtimine: **Vajutusnupp ümmargune roostevaba teras**
Nupu kasutamiseks on vaja 35 mm auku
Ülevool: **katteplaadiga ülevool**
Tööpind: **min paksus 12 mm**

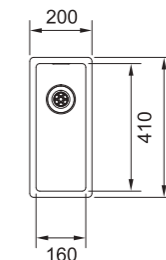

Valamu põhjaga integreeritud ekstsentrisklapiga valamu, mida juhitakse nupuga.

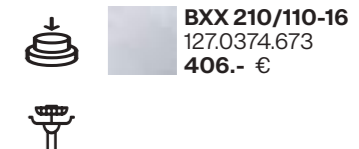

BXX 210/110-16
127.0374.673
406.- €

Enne tööpinna paigaldamist peab olema ülevooluploki väljalõige:

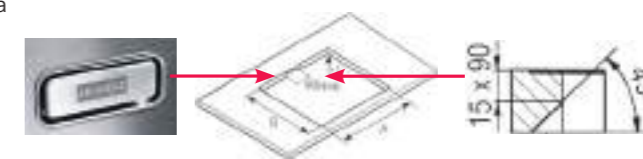

Maris



Lisad



112.0520.497
Nõrutuskauss- roostevaba teras
181 x 431 mm
77.- €

112.0520.471
Lõikelaud polietilēna
200 x 510 x 16 mm
47.- €

112.0030.882
Rollmatt painduv
468 x 420 mm
83.- €

112.0188.651
Rv Mobiilne nõruti plastik raamis
342 x 430 x 22 mm
114.- €



ALL-IN
5 erinevat komplekti ALL IN (rohkem lk 137) valamule: 340 x 540 mm
130.- ... 247.- €

MARIS

- 1
- 2
- 3
- 4
- 5



Mudel: **MRX 210-70TL**
Aluskapp: **80 cm**
Mõõdud: **730 x 510 mm**
Väljalõige: **710 x 490 mm (R=10mm)**
Kausi mõõtmed: **700/400/180 mm**
Paigaldamine: **Slim Top või tasapinnaline**
Materjal: **roostevaba teras poleeritud**
Ventil: **manuaalne 3½" ventiil**
Ventili juhtimine: **käsi avamine/ sulgemine**
Ülevool: **katteplaadiga ülevool**
Segisti auk: **35 mm auk**

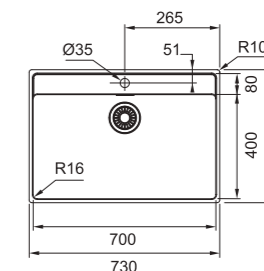

MRX 210-70TL
127.0531.917
479.- €

MARIS

- 1
- 2
- 3
- 4
- 5



Mudel: **MRX 210-50TL**
Aluskapp: **60 cm**
Mõõdud: **530 x 510 mm**
Väljalõige: **510 x 490 mm (R = 10 mm)**
Kausi mõõtmed: **500 /400 /180 mm**
Paigaldamine: **Slim Top või tasapinnaline**
Materjal: **roostevaba teras poleeritud**
Ventil: **manuaalne 3½" ventiil**
Ventili juhtimine: **käsi avamine/ sulgemine**
Ülevool: **katteplaadiga ülevool**
Segisti auk: **35 mm auk**

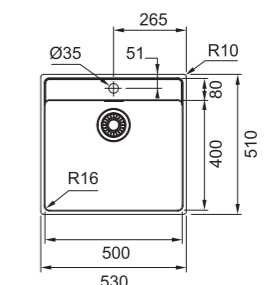

MRX 210-50TL
127.0531.852
353.- €

MARIS

- 3
- 4
- 5



Mudel: **MRX 210-40TL**
Aluskapp: **50 cm**
Mõõdud: **430 x 510 mm**
Väljalõige: **410 x 490 mm (R = 10 mm)**
Kausi mõõtmed: **400 /400 /180 mm**
Paigaldamine: **Slim Top või tasapinnaline**
Materjal: **roostevaba teras poleeritud**
Ventil: **manuaalne 3½" ventiil**
Ventili juhtimine: **käsi avamine/ sulgemine**
Ülevool: **katteplaadiga ülevool**
Segisti auk: **35 mm auk**

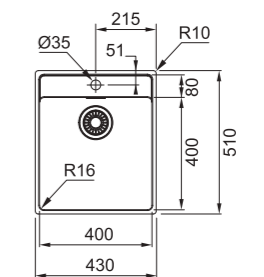

MRX 210-40TL
127.0531.851
328.- €

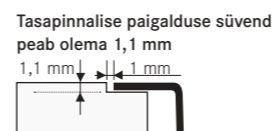

Tasapinnalise paigalduse süvend peab olema 1,1 mm

Maris



Lisad



1
ALL-IN
5 erinevat komplekti ALL IN
(rohkem lk 137) valamule:
340 x 540 mm
130.- ... 247.- €

2
112.0030.882
Rollmatt painduv
468 x 420 mm
83.- €

3
112.0188.651
Rv Mobiilne nõruti plastik
raamis
342 x 430 x 22 mm
114.- €

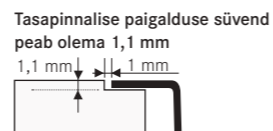

Mudel: **MRX 210-70**
Aluskapp: **80 cm**
Mõõdud: **740 x 440 mm**
Väljalõige: **710 x 410 mm (R = 10 mm)**
Kausi mõõtmed: **700 /400 /180 mm**
Paigaldamine: **Slim Top või tasapinnaline**
Materjal: **roostevaba teras poleeritud**
Ventil: **manuaalne 3½" ventiil**
Ventili juhtimine: **käsitsi avamine/ sulgemine**
Ülevool: **katteplaadiga ülevool**
Segisti auk: **ei**

MRX 210-70
127.0531.916
384.- €

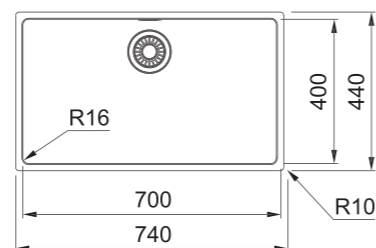

Mudel: **MRX 210-50**
Aluskapp: **60 cm**
Mõõdud: **540 x 440 mm**
Väljalõige: **510 x 410 mm (R = 10 mm)**
Kausi mõõtmed: **500 /400 /180 mm**
Paigaldamine: **Slim Top või tasapinnaline**
Materjal: **roostevaba teras poleeritud**
Ventil: **manuaalne 3½" ventiil**
Ventili juhtimine: **käsitsi avamine/ sulgemine**
Ülevool: **katteplaadiga ülevool**
Segisti auk: **ei**

MRX 210-50
127.0531.810
328.- €

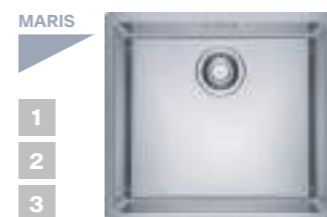
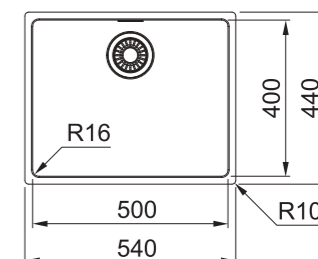

Mudel: **MRX 210-45**
Aluskapp: **50 cm**
Mõõdud: **490 x 440 mm**
Väljalõige: **460 x 410 mm (R = 10 mm)**
Kausi mõõtmed: **450 /400 /180 mm**
Paigaldamine: **Slim Top või tasapinnaline**
Materjal: **roostevaba teras poleeritud**
Ventil: **manuaalne 3½" ventiil**
Ventili juhtimine: **käsitsi avamine/ sulgemine**
Ülevool: **katteplaadiga ülevool**
Segisti auk: **ei**

MRX 210-45
127.0553.961
315.- €

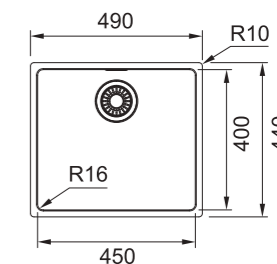

Mudel: **MRX 210-40**
Aluskapp: **50 cm**
Mõõdud: **440 x 440 mm**
Väljalõige: **410 x 410 mm (R = 10 mm)**
Kausi mõõtmed: **400 /400 /180 mm**
Paigaldamine: **Slim Top või tasapinnaline**
Materjal: **roostevaba teras poleeritud**
Ventil: **manuaalne 3½" ventiil**
Ventili juhtimine: **käsitsi avamine/ sulgemine**
Ülevool: **katteplaadiga ülevool**
Segisti auk: **ei**

MRX 210-40
127.0531.809
302.- €

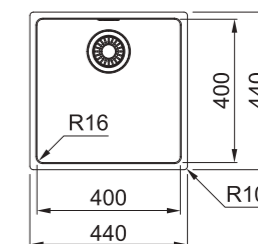

Mudel: **MRX 210-34**
Aluskapp: **40 cm**
Mõõdud: **380 x 440 mm**
Väljalõige: **350 x 410 mm (R = 10 mm)**
Kausi mõõtmed: **340 /400 /180 mm**
Paigaldamine: **Slim Top või tasapinnaline**
Materjal: **roostevaba teras poleeritud**
Ventil: **manuaalne 3½" ventiil**
Ventili juhtimine: **käsitsi avamine/ sulgemine**
Ülevool: **katteplaadiga ülevool**
Segisti auk: **ei**

MRX 210-34
127.0531.915
292.- €

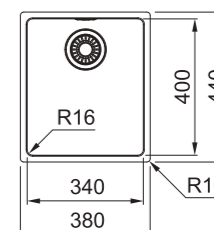



MARIS

1
2



Mudel: **AGX 211-78**
 Aluskapp: **45 cm**
 Mõõdud: **780 x 510 mm**
 Väljalõige: **767 x 497 mm (R= 10 mm)**
 Kausi mõõtmed: **350 /435 /175 mm**
 Kausi asukoht: **pööratav**
 Paigaldamine: **Slim Top või tasapinnaline**
 Materjal: **roostevaba teras poleeritud**
 Ventiiil: **integreeritud ventiil**
 Ventiiili juhtimine: **Vajutusnupp ümmargune roostevaba teras**
 Ülevool: **katteplaadiga ülevool**
 Segisti auk: **2x 35 mm**

AGX 211-78
 127.0476.541
425.- €

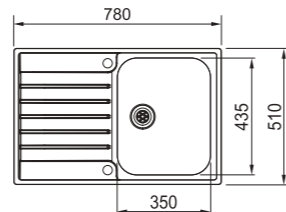

Lisad

1



ALL-IN
 5 erinevat komplekti ALL IN (rohkem lk 137) valamule: 340 x 540 mm
 130.- ... 247.- €

2



112.0281.982
 Rullmatt painduv 400 x 458 mm
 93.- €

MARIS

1
2



Mudel: **AGX 211-62**
 Aluskapp: **45 cm**
 Mõõdud: **625 x 510 mm**
 Väljalõige: **612 x 497 mm (R= 10 mm)**
 Kausi mõõtmed: **350 /435 /175 mm**
 Kausi asukoht: **pööratav**
 Paigaldamine: **Slim Top või tasapinnaline**
 Materjal: **roostevaba teras poleeritud**
 Ventiiil: **integreeritud ventiil**
 Ventiiili juhtimine: **Vajutusnupp ümmargune roostevaba teras**
 Ülevool: **katteplaadiga ülevool**
 Segisti auk: **2x 35 mm**

AGX 211-62
 127.0476.450
386.- €

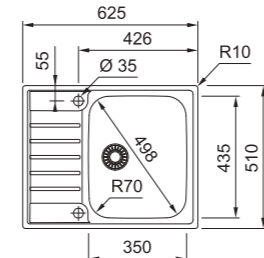

SMART

1



Mudel: **BCX 610-51**
 Aluskapp: **50 cm**
 Mõõdud: **510 x 510 mm**
 Väljalõige: **490 x 490 mm**
 Kausi mõõtmed: **445 /380 /200 mm**
 Paigaldamine: **süvistatav**
 Materjal: **roostevaba teras poleeritud**
 Ventiiil: **manuaalne 3½" ventiil**
 Ventiiili juhtimine: **põhjasõela käsitsi avamine**
 Segisti auk: **35 mm auk**

BCX 610-51
 101.0622.893
133.- €

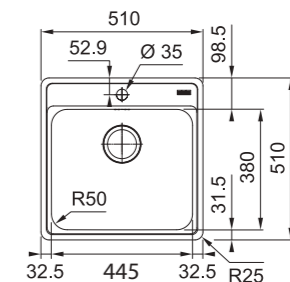



1
2



Mudel: **SKX 611-79**
 Aluskapp: **45 cm**
 Mõõdud: **790 x 500 mm**
 Väljalõige: **770 x 480 mm (R = 10 mm)**
 Kausi mõõtmed: **340 /420 /160 mm**
 Kausi asukoht: **pööratav**
 Paigaldamine: **süvistatav**
 Materjal: **roostevaba teras poleeritud**
 Ventiiil: **nupuga avatav 3½" ventiil**
 Ventiiili juhtimine: **keeratav nupp**
 Segisti auk: **segisti ja nupu jaoks 2x 35 mm auk**
 Tööpind: **min 30 mm paksune**

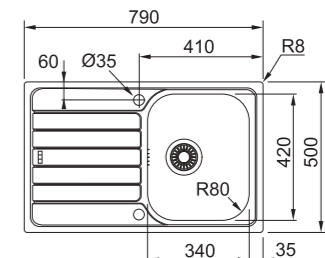

SKX 611-79*
 101.0554.878*
138.- €

* - Mudel on saadaval kuni 2025. aasta detsembrini



Mudel: **SKN 611-78/44**
SKL 611-78/44
 Aluskapp: **45 cm**
 Mõõdud: **780 x 435 mm**
 Väljalõige: **760 x 415 mm (R = 10 mm)**
 Kausi mõõtmed: **340 /370 /150 mm**
 Kausi asukoht: **pööratav**
 Paigaldamine: **süvistatav**
 Materjal: **roostevaba teras**
 Ventiiil: **manuaalne 3½" ventiil**
 Ventiiili juhtimine: **põhjasõela käsitsi avamine**
 Segisti auk: **ei**
 Tööpind: **min 30 mm paksune**

NEW

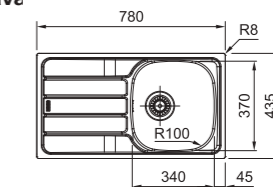

Roostevaba teras, matt

SKN 611-78/44
 101.0729.490
106.- €

Roostevaba teras linane

SKL 611-78/44
 101.0729.492
118.- €



Mudel: **SKN 611-86/44**
 Aluskapp: **45 cm**
 Mõõdud: **860 x 435 mm**
 Väljalõige: **840 x 415 mm (R = 10 mm)**
 Kausi mõõtmed: **340 /370 /150 mm**
 Kausi asukoht: **pööratav**
 Paigaldamine: **süvistatav**
 Materjal: **roostevaba teras**
 Ventiiil: **manuaalne 3½" ventiil**
 Ventiiili juhtimine: **põhjasõela käsitsi avamine**
 Segisti auk: **ei**
 Tööpind: **min 30 mm paksune**

NEW

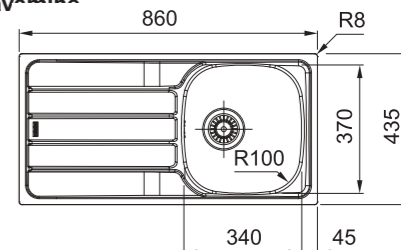

SKN 611-86/44
 101.0729.489
110.- €



Mudel: **SKX 651**
 Aluskapp: **60 cm**
 Mõõdud: **1000 x 500 mm**
 Väljalõige: **980 x 480 mm (R = 10 mm)**
 Kausi mõõtmed: **340 /420 /160 + 170 /280 /80 mm**
 Kausi asukoht: **pööratav**
 Paigaldamine: **süvistatav**
 Materjal: **roostevaba teras poleeritud**
 Ventiiil: **nupuga avatav 3½" ventiil**
 Ventiiili juhtimine: **keeratav nupp**
 Segisti auk: **segisti ja nupu jaoks 2x 35 mm auk**
 Tööpind: **min 30 mm paksune**
 Komplekt: **Roostevabast terasest nõrutuskauss**
112.0461.942

1
2
3
4

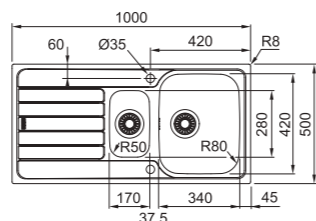

SKX 651
 101.0464.044
205.- €



Mudel: **SKX 611-86**
 Aluskapp: **45 cm**
 Mõõdud: **860 x 500 mm**
 Väljalõige: **840 x 480 mm (R = 10 mm)**
 Kausi mõõtmed: **340 /420 /160 mm**
 Kausi asukoht: **pööratav**
 Paigaldamine: **süvistatav**
 Materjal: **roostevaba teras poleeritud**
 Ventiiil: **nupuga avatav 3½" ventiil**
 Ventiiili juhtimine: **keeratav nupp**
 Segisti auk: **segisti ja nupu jaoks 2x 35 mm auk**
 Tööpind: **min 30 mm paksune**

1
2

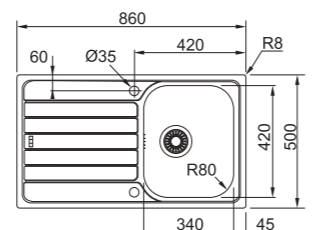

SKX 611-86
 101.0464.337
148.- €

Lisad

1

 ALL-IN
 5 erinevat komplekti ALL IN
 (rohkem lk 137) valamule:
 340 x 540 mm
 130.- ... 247.- €

2

 112.0595.334
 Lõikelaud puit
 532 x 280 mm
 48.- €

3

 112.0461.942
 Roostevabast terasest
 kandik
 297 x 187 x 72 mm
 41.- €

4

 112.0461.952
 Madal kandik roostevabast
 terasest
 297 x 187 x 22 mm
 32.- €

Spark



1
2



Mudel: **SKX 620-86**
Aluskapp: **80 cm**
Mõõdud: **860 x 500 mm**
Väljalõige: **840 x 480 mm (R = 10 mm)**
Kausi mõõtmed: **2x 339 / 409 / 155 mm**
Kausi asukoht: **pööratav**
Materjal: **roostevaba teras poleeritud**
Paigaldamine: **süvistatav**
Ventil: **nupuga avatav 3½" ventiil**
Ventili juhtimine: **keeratav nupp**
Segisti auk: **segisti ja nupu jaoks 2x 35 mm auk**
Tööpind: **min 30 mm paksune**

NEW **SKX 620-86**
101.0714.950
185.- €

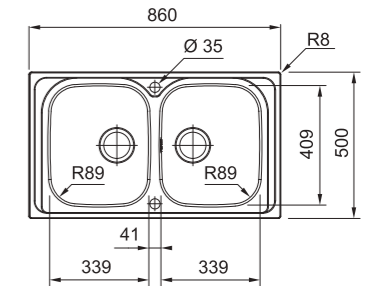

Mudel: **SKL 611-62/50**
SKL 611-62/50
Aluskapp: **45 cm**
Mõõdud: **620 x 500 mm**
Väljalõige: **600 x 480 mm (R = 10 mm)**
Kausi mõõtmed: **340 / 420 / 160 mm**
Kausi asukoht: **pööratav**
Materjal: **roostevaba teras**
Paigaldamine: **süvistatav**
Ventil: **nupuga avatav 3½" ventiil**
Ventili juhtimine: **keeratav nupp**
Segisti auk: **segisti ja nupu jaoks 2x 35 mm auk**
Tööpind: **min 30 mm paksune**

Roostevaba teras, matt
SKX 611-62/50
101.0714.948
141.- €

Roostevaba teras linane
SKL 611-62/50
101.0729.488
137.- €

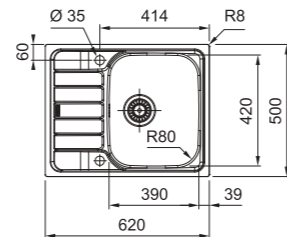

Mudel: **SKN 611-62/44**
Aluskapp: **45 cm**
Mõõdud: **620 x 435 mm**
Väljalõige: **600 x 415 mm (R = 10 mm)**
Kausi mõõtmed: **340 / 370 / 150 mm**
Materjal: **roostevaba teras**
Paigaldamine: **süvistatav**
Ventil: **manuaalne 3½" ventiil**
Ventili juhtimine: **põhjasõela käsitsi avamine**
Segisti auk: **ei**
Tööpind: **min 30 mm paksune**

NEW **SKN 611-62/44**
101.0729.493
98.- €

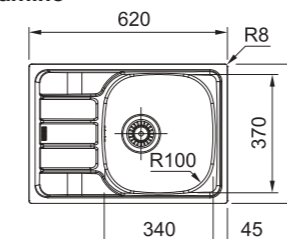

Mudel: **SKN 610-37/44**
Aluskapp: **45 cm**
Mõõdud: **455 x 435 mm**
Väljalõige: **435 x 415 mm (R = 10 mm)**
Kausi mõõtmed: **370 / 340 / 150 mm**
Materjal: **roostevaba teras**
Paigaldamine: **süvistatav**
Ventil: **manuaalne 3½" ventiil**
Ventili juhtimine: **põhjasõela käsitsi avamine**
Segisti auk: **ei**
Tööpind: **min 30 mm paksune**

NEW **SKN 610-37/44**
101.0714.957
88.- €

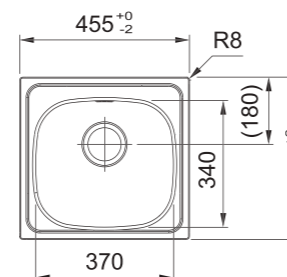

Mudel: **SKX 621**
Aluskapp: **80 cm**
Mõõdud: **1160 x 500 mm**
Väljalõige: **1140 x 480 mm (R = 10 mm)**
Kausi mõõtmed: **2x 340 / 420 / 155 mm**
Kausi asukoht: **pööratav**
Materjal: **roostevaba teras poleeritud**
Paigaldamine: **süvistatav**
Ventil: **nupuga avatav 3½" ventiil**
Ventili juhtimine: **keeratav nupp**
Segisti auk: **segisti ja nupu jaoks 2x 35 mm auk**
Tööpind: **min 30 mm paksune**

NEW **SKX 621**
101.0469.740
215.- €

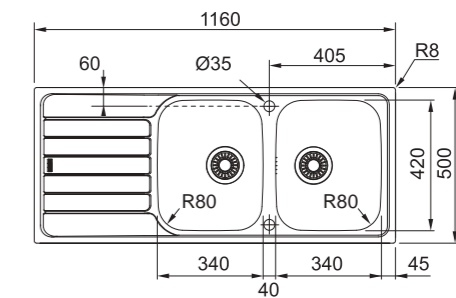

Mudel: **SKX 651-95-E**
Aluskapp: **65 cm**
Mõõdud: **945 x 510 mm**
Väljalõige: **Šablooni järgi**
Kausi mõõtmed: **339 / 419 / 150 + 233 / 253 / 80 mm**
Paigaldamine: **süvistatav**
Materjal: **roostevaba teras poleeritud**
Ventil: **nupuga avatav 3½" ventiil**
Ventili juhtimine: **keeratav nupp**
Segisti auk: **segisti ja nupu jaoks 2x 35 mm auk**
Tööpind: **min 30 mm paksune**

NEW **SKX 651-95-E**
101.0714.951
256.- €

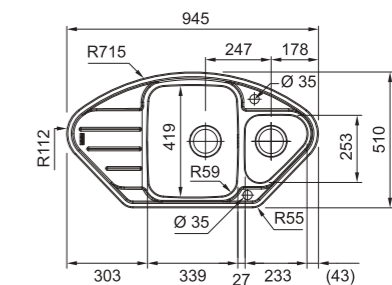

Lisad



ALL-IN
5 erinevat komplekti ALL IN
(rohkem lk 137) valamule:
340 x 540 mm
130.- ... 247.- €



112.0595.334
Lõikelaud puit
532 x 280 mm
48.- €



112.0006.138
Roostevabast terasest
kandik
200 x 265 x 70 mm
33.- €



Lisad



ALL-IN
5 erinevat komplekti ALL IN
(rohkem lk 137) valamule:
340 x 540 mm
130.- ... 247.- €

112.0595.334
Lõikelaud puit
532 x 280 mm
48.- €

1
2



Mudel: **RPX 611-86XL**
Aluskapp: **60 cm**
Mõõdud: **860 x 500 mm**
Väljalõige: **840 x 480 mm (R = 20 mm)**
Kausi mõõtmed: **450 / 400 / 200 mm**
Kausi asukoht: **pööratav**
Paigaldamine: **süvistatav**
Materjal: **roostevaba teras poleeritud**
Ventili: **nupuga avatav 3½" ventii**
Ventili juhtimine: **PopUp keeratav nupp**
Ülevool: **katteplaadiga ülevool**
Segisti auk: **segisti ja nupu jaoks 2x 35 mm auk**

RPX 611-86XL
101.0498.889
234.- €

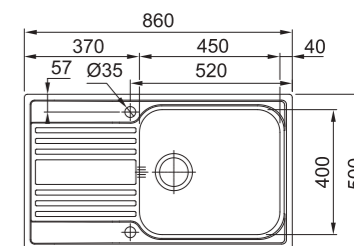

1
2



Mudel: **LLX 611**
Aluskapp: **45 cm**
Mõõdud: **790 x 500 mm**
Väljalõige: **770 x 480 mm (R = 20 mm)**
Kausi mõõtmed: **340 / 400 / 195 mm**
Paigaldamine: **süvistatav**
Materjal: **roostevaba teras poleeritud**
Ventili: **manuaalne 3½" ventii**
Ventili juhtimine: **põhjasõela käsitsi avamine**
Segisti auk: **35 mm**

Suur kauss paremal



LLX 611
101.0085.773
179.- €

Suur kauss vasakul



LLX 611
101.0085.772
179.- €

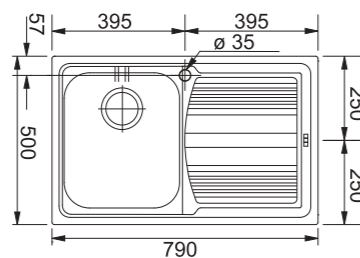

Ruumi säästva sifooni paigaldamine



112.0006.412
Universaalne ruumisäästlik
sifoon 1½" 1 m
7.- €





Lisad



1
ALL-IN
5 erinevat komplekti ALL IN
(rohkem lk 137) valamule:
340 x 540 mm
130.- ... 247.- €



2
112.0595.334
Lõikelaud puit
532 x 280 mm
47.- €



3
112.0461.942
Nõrutuskauss- roostevaba
teras 297 x 187 x 72 mm
31.- €



Mudel: **AZN 651**
Aluskapp: **60 cm**
Mõõdud: **1000 x 500 mm**
Väljalõige: **980 x 480 mm (R=10 mm)**
Kausi mõõtmed: **340 / 420 / 155 + 170 / 280 / 80 mm**
Kausi asukoht: **pööratav**
Paigaldamine: **süvistatav**
Materjal: **roostevaba teras**
Ventil: **manuaalne 3½" ventiil**
Ventili juhtimine: **põhjasõela käsitsi avamine**
Segisti auk: **ilma aukudeta**

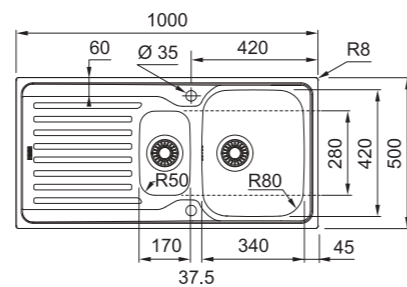

NEW AZN 651
101.0463.814
137.- €



Mudel: **AZN 611-62**
Aluskapp: **45 cm**
Mõõdud: **620 x 500 mm**
Väljalõige: **600 x 480 mm (R=10 mm)**
Kausi mõõtmed: **360 / 420 / 155 mm**
Kausi asukoht: **pööratav**
Paigaldamine: **süvistatav**
Materjal: **roostevaba teras**
Ventil: **manuaalne 3½" ventiil**
Ventili juhtimine: **põhjasõela käsitsi avamine**
Segisti auk: **ilma aukudeta**

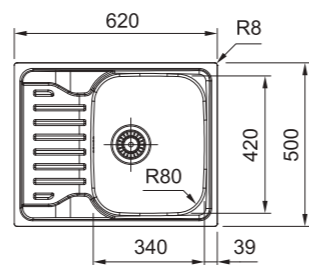

NEW AZN 611-62
101.0727.747
127.- €



Mudel: **ROX 610-39**
RON 610-39
ROL 610-39

Aluskapp: **50 cm**
Mõõdud: **Ø 509 mm**
Väljalõige: **Ø 489 mm**
Kausi mõõtmed: **Ø 388 / 175 mm**
Materjal: **roostevaba teras**
Paigaldamine: **süvistatav**
Ventil: **manuaalne 3½" ventiil**
Ventili juhtimine: **põhjasõela käsitsi avamine**
Segisti auk: **35 mm auk**

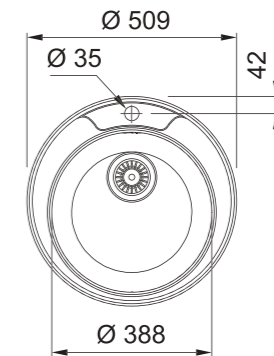

Roostevaba teras poleeritud

ROX 610-39
101.0714.971
84.- €

Roostevaba teras, matt

RON 610-39
101.0714.972
79.- €

Roostevaba teras linane

ROL 610-39
101.0734.373
81.- €



Mudel: **ROX 610/110-38**

Aluskapp: **45 cm**
Mõõdud: **Ø 435 mm**
Väljalõige: **Ø 415 mm**
Kausi mõõtmed: **Ø 378 / 180 mm**
Materjal: **roostevaba teras**
Paigaldamine: **süvistatav**
Ventil: **manuaalne 3½" ventiil**
Ventili juhtimine: **põhjasõela käsitsi avamine**
Segisti auk: **ei**
Tööpind: **min 30 mm paksune**

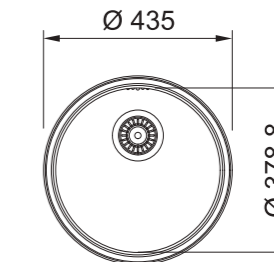

Roostevaba teras poleeritud

ROX 610/110-38
101.0725.057
82.- €

Fragranit valamud



62

Fresno

63

Mythos

64

Maris

74

Urban

78

Centro

80

Basis

84

Strata

86

Ronda



Fragranit valamud

MYTHOS

MARIS
SMART

Aluskapp
80 cm

Aluskapp
60 cm

Aluskapp
50 cm

Aluskapp
40 cm



MRG 610-72A
69. lk.



BFG 620
83. lk.

Nurgavalamud



MRG 612-E
68. lk.



FSG 611-88
62. lk.



MTG 611
63. lk.



MRG 651
65. lk.



BFG 651
81. lk.



UBG 651-100
74. lk.



MRG 651-78
65. lk.



BFG 651-78
81. lk.



MRG 611-78XL
67. lk.



UBG 611-78XL
76. lk.



UBG 611-100
75. lk.



MRG 611-100XL
65. lk.



MRG 611-100
66. lk.



MRG 610-54A
70. lk.



MRG 610-52A
71. lk.



UBG 610-56
77. lk.



CNG 611-86
85. lk.



UBG 611-86
75. lk.



MRG 611
67. lk.

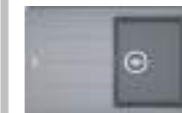

BFG 611
83. lk.



UBG 611-62
77. lk.



UBG 611-78
75. lk.



MRG 611-62
67. lk.



CNG 611-62
79. lk.



CNG 611-78
79. lk.



BFG 611-62
83. lk.



MRG 610-39A
72. lk.



BFG 611-86
81. lk.



MRG 610-37A
73. lk.



STG 614
85. lk.



STG 614-78
85. lk.



ROG 611
87. lk.



ROG 611-62
87. lk.



ROG 610-41
87. lk.



Lisad

- | | | | |
|---|---|---|---|
| 1 | 2 | 3 | 4 |
| | | | |
| 112.0018.817
Nõrutuskauss- roostevaba teras 160 x 405 mm
47.- € | 112.0066.060
Roostevabast terasest nõrutuskauss plastkäepide-metega 156 x 417 x 54 mm
110.- € | 112.0017.900
Lõikelaud- klaas 280 x 408 mm
47.- € | 112.0473.656
Augufrees 35mm Fragranit valamutele Ø35 mm
5.- € |

MYTHOS



Mudel: **FSG 611-88**
 Aluskapp: **60 cm**
 Mõõdud: **877 x 495 mm**
 Väljalõige: **845 x 463 mm (R = 20 mm)**
 Kausi mõõtmed: **496 /425 /195 mm**
 Paigaldamine: **süvistatav**
 Kausi asukoht: **pööratav**
 Materjal: **Fragranit**
 Ventiiil: **Sealhulgas ventiiil 3½" vajutusnupuga**
 Ventiiili juhtimine: **Vajutusnupp ümmargune roostevaba teras**
 Ventiiil kaas: **Katteplaadiga ülevool**
 Ülevool: **katteplaadiga ülevool**
 Segisti auk: **ilma aukudeta (2 x 35 mm altpoolt puuritud augud)**
 Tööpind: **min 30 mm paksune**
 Sisaldub komplektis: **Rollmatt 112.0520.938**
 Erimärksused:
Kraan ja ventiiil tuleb enne valamu paigaldamist paigaldada. Kui valamu paigaldatakse 60 cm kappi, võib külgeina paksus olla maksimaalselt 16 mm

Onyx
114.0593.108
663.- €

Must matt
114.0627.323
677.- €

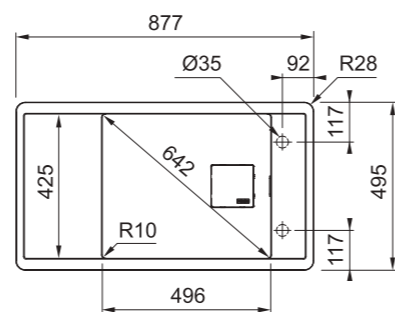

MYTHOS



1

3

4



Mudel: **MTG 611**
 Aluskapp: **60 cm**
 Mõõdud: **1000 x 515 mm**
 Väljalõige: **980 x 495 mm (R=25 mm)**
 Kausi mõõtmed: **500 /390 /190 mm**
 Paigaldamine: **süvistatav**
 Materjal: **Fragranit**
 Ventiiil: **Sealhulgas ventiiil 3½" vajutusnupuga**
 Ventiiili juhtimine: **Vajutusnupp ümmargune roostevaba teras**
 Ülevool: **katteplaadiga ülevool**
 Segisti auk: **ilma aukudeta (3 x 35 mm altpoolt puuritud augud)**
 Tööpind: **min 30 mm paksune**

Suur kauss paremal



Polaarvalge
114.0477.021
394.- €

Kivihall
114.0476.999
394.- €



Slate Grey
114.0723.963
394.- €

Cashmere
114.0477.041
394.- €

Onyx
114.0476.995
394.- €

Suur kauss vasakul



Polaarvalge
114.0477.022
394.- €

Kivihall
114.0477.000
394.- €



Slate Grey
114.0723.964
394.- €

Cashmere
114.0477.044
394.- €

Onyx
114.0476.996
394.- €

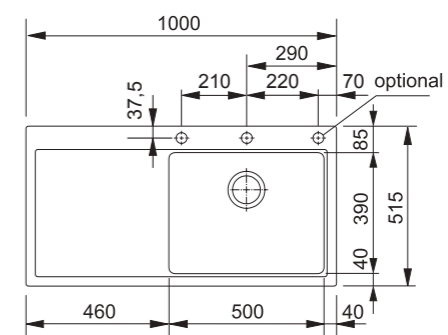

Maris



Lisad



112.0256.867
Rollmatt painduv
298 x 410 mm
45.- €



ALL-IN
5 erinevat komplekti ALL IN
(rohkem lk 137) valamule:
340 x 540 mm
130.- ... 247.- €



115.0595.081
URBAN Onyx värvi segisti
209.- €

MARIS

1
2



Mudel: **MRG 651**
Aluskapp: **60 cm**
Mõõdud: **970 x 500 mm**
Väljalõige: **950 x 480 mm (R=20mm)**
Kausi mõõtmed: **350 /425 /200 + 160 /302 /120 mm**
Paigaldamine: **süvistatav**
Kausi asukoht: **pööratav**
Materjal: **Fragranit**
Ventil: **nupuga avatav 3½" ventiil**
Ventili juhtimine: **Ümar keeratav nupp sõela avamiseks või sulgemiseks**
Ülevool: **katteplaadiga ülevool**
Sisaldub komplektis: **Roostevabast terasest nõrutuskauss 112.0057.214**
Segisti auk: **ilma aukudeta (2 x 35 mm altpoolt puuritud augud)**
Tööpind: **min 30 mm paksune**

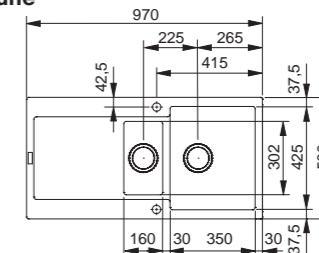
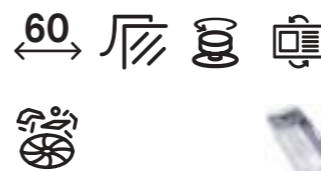

Polaarvalge
114.0055.823
421.- €

Kivihall
114.0055.819
421.- €

Cashmere
114.0302.676
421.- €

Onyx
114.0176.602
421.- €

Must matt
114.0627.286
434.- €

MARIS

1
2



Mudel: **MRG 651-78**
Aluskapp: **60 cm**
Mõõdud: **780 x 500 mm**
Väljalõige: **760 x 480 mm (R=20mm)**
Kausi mõõtmed: **350 /425 /200 + 160 /300 /120 mm**
Paigaldamine: **süvistatav**
Kausi asukoht: **pööratav**
Materjal: **Fragranit**
Ventil: **nupuga avatav 3½" ventiil**
Ventili juhtimine: **Ümar keeratav nupp sõela avamiseks või sulgemiseks**
Ülevool: **katteplaadiga ülevool**
Sisaldub komplektis: **Roostevabast terasest nõrutuskauss 112.0057.214**
Segisti auk: **ilma aukudeta (4 x 35 mm altpoolt puuritud augud)**
Tööpind: **min 30 mm paksune**

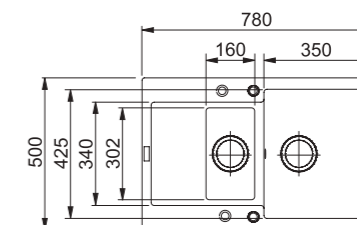
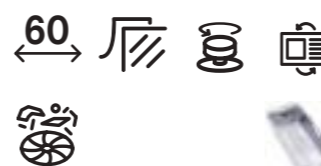

Polaarvalge
114.0253.334
386.- €

Kivihall
114.0253.335
386.- €

Cashmere
114.0302.683
386.- €

Onyx
114.0253.333
386.- €

Must matt
114.0627.289
399.- €

MARIS

1
2



Mudel: **MRG 611-100XL**
Aluskapp: **60 cm**
Mõõdud: **970 x 500 mm**
Väljalõige: **950 x 480 mm (R=20mm)**
Kausi mõõtmed: **490/425 /200 mm**
Paigaldamine: **süvistatav**
Kausi asukoht: **pööratav**
Materjal: **Fragranit**
Ventil: **nupuga avatav 3½" ventiil**
Ventili juhtimine: **Ümar keeratav nupp sõela avamiseks või sulgemiseks**
Ülevool: **katteplaadiga ülevool**
Segisti auk: **ilma aukudeta (4 x 35 mm altpoolt puuritud augud)**
Tööpind: **min 30 mm paksune**

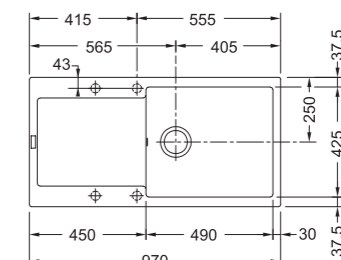
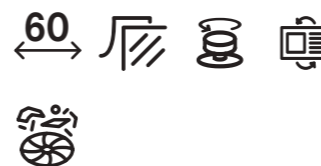

Polaarvalge
114.0378.095
386.- €

Kivihall
114.0378.124
386.- €

Cashmere
114.0378.121
386.- €

Onyx
114.0378.126
386.- €

Must matt
114.0627.363
400.- €

Maris



Lisad



112.0256.867
Rullmatt paindub
298 x 410 mm
45.- €



2 ALL-IN
5 erinevat komplekti ALL IN
(rohkem lk 137) valamule:
340 x 540 mm
130.- ... 247.- €



115.0595.081
URBAN Onyx värvi segisti
209.- €



Mudel: **MRG 611-100**
Aluskapp: **60 cm**
Mõõdud: **970 x 500 mm**
Väljalõige: **950 x 480 mm (R=20mm)**
Kausi mõõtmed: **450/425 /200 mm**
Paigaldamine: **süvistatav**
Kausi asukoht: **pööratav**
Materjal: **Fragranit**
Ventil: **nupuga avatav 3½" ventiil**
Ventili juhtimine: **Ümar keeratav nupp sõela avamiseks või sulgemiseks**
Ulevool: **katteplaadiga ülevool**
Segisti auk: **ilma aukudeta (4 x 35 mm altpoolt puuritud augud)**
Tööpind: **min 30 mm paksune**

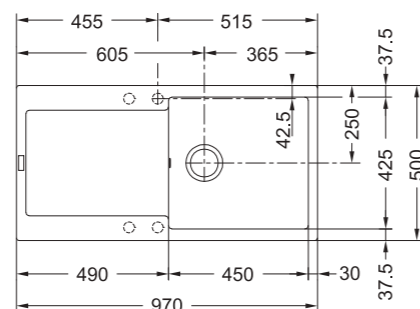

Polaarvalge
114.0176.596
386.- €

Kivihall
114.0176.594
386.- €

Cashmere
114.0302.693
386.- €

Onyx
114.0176.600
386.- €



Mudel: **MRG 611-62**
Aluskapp: **45 cm**
Mõõdud: **620 x 500 mm**
Väljalõige: **600 x 480 mm (R=20mm)**
Kausi mõõtmed: **350/425 /200 mm**
Paigaldamine: **süvistatav**
Kausi asukoht: **pööratav**
Materjal: **Fragranit**
Ventil: **nupuga avatav 3½" ventiil**
Ventili juhtimine: **Ümar keeratav nupp sõela avamiseks või sulgemiseks**
Ulevool: **katteplaadiga ülevool**
Segisti auk: **ilma aukudeta (4 x 35 mm altpoolt puuritud augud)**
Tööpind: **min 30 mm paksune**

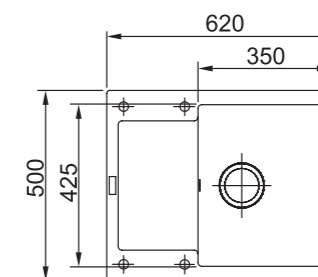

Polaarvalge
114.0253.323
334.- €

Kivihall
114.0253.324
334.- €

Cashmere
114.0302.708
334.- €

Onyx
114.0253.322
334.- €

Must matt
114.0627.370
347.- €



Mudel: **MRG 611-78XL**
Aluskapp: **60 cm**
Mõõdud: **780 x 500 mm**
Väljalõige: **760 x 480 mm (R=20mm)**
Kausi mõõtmed: **3490 /425 /200 mm**
Paigaldamine: **süvistatav**
Kausi asukoht: **pööratav**
Materjal: **Fragranit**
Ventil: **nupuga avatav 3½" ventiil**
Ventili juhtimine: **Ümar keeratav nupp sõela avamiseks või sulgemiseks**
Ulevool: **katteplaadiga ülevool**
Segisti auk: **ilma aukudeta (4 x 35 mm altpoolt puuritud augud)**
Tööpind: **min 30 mm paksune**

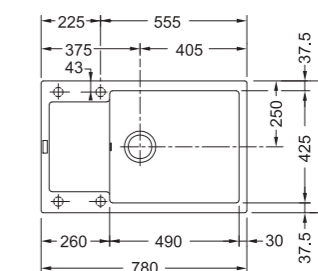

Polaarvalge
114.0479.022
364.- €

Kivihall
114.0479.030
364.- €

Cashmere
114.0479.027
364.- €

Onyx
114.0479.032
364.- €

Must matt
114.0627.365
378.- €



Mudel: **MRG 611**
Aluskapp: **45 cm**
Mõõdud: **780 x 500 mm**
Väljalõige: **760 x 480 mm (R=20mm)**
Kausi mõõtmed: **350 /425 /200 mm**
Paigaldamine: **süvistatav**
Kausi asukoht: **pööratav**
Materjal: **Fragranit**
Ventil: **nupuga avatav 3½" ventiil**
Ventili juhtimine: **Ümar keeratav nupp sõela avamiseks või sulgemiseks**
Ulevool: **katteplaadiga ülevool**
Segisti auk: **ilma aukudeta (4 x 35 mm altpoolt puuritud augud)**
Tööpind: **min 30 mm paksune**

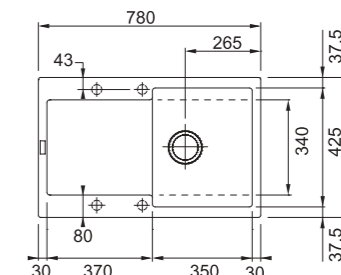

Polaarvalge
114.0055.697
364.- €

Kivihall
114.0055.695
364.- €

Cashmere
114.0302.705
364.- €

Onyx
114.0176.603
364.- €

Must matt
114.0627.367
378.- €



Lisad

- | | | | | |
|--|---|---|--|---|
| 1 | 2 | 3 | 4 | 5 |
|  |  |  |  |  |
| 112.0030.882
Rullmatt paindub
468 x 420 mm
83.- € | 112.0188.651
Rv Mobiilne nõruti plastik
raamis 342 x 430 x 22 mm
114.- € | 112.0532.169
Roostevaba teras ventiili
kate 3½"
10.- € | 112.0657.146
Must matt ventiili kate 3½"
11.- € | ALL-IN
5 erinevat komplekti ALL IN
(rohkem lk 137) valamule:
340 x 540 mm
130.- ... 247.- € |

MARIS 5  Mudel: **MRG 612-E**
Aluskapp: **60 cm**
Mõõdud: **960 x 500 mm**
Väljalõige: **Sablooni järgi**
Kausi mõõtmed: **350 / 425 / 200 mm**
Paigaldamine: **süvistatav**
Materjal: **Fragranit**
Ventiil: **nupuga avatav 3½" ventiil**
Ventiili juhtimine: **Ümar keeratav nupp sõela avamiseks või sulgemiseks**
Ülevool: **katteplaadiga ülevool**
Segisti auk: **ilma aukudeta (2 x 35 mm altpoolt puuritud augud)**

Onyx
114.0197.774
461.- €

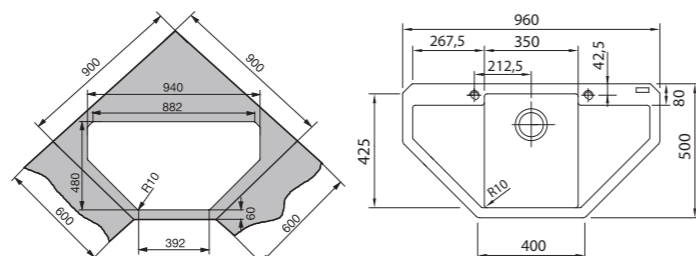

MARIS

- 1
- 2
- 3
- 4
- 5



Mudel: **MRG 610-72A**
Aluskapp: **80 cm**
Mõõdud: **760 x 510 mm**
Väljalõige: **740 x 498 mm (R=15 mm)**
Kausi mõõtmed: **720 / 400 / 200 mm**
Paigaldamine: **süvistatav**
Materjal: **Fragranit**
Ventiil: **koos ventiiliga 3½"**
Ventiili juhtimine: **vajutusnupp või pöördnupp või käsitsi sõela avamine/sulgemine**
Ventiil kaas: **ümarmargune**
Ülevool: **katteplaadiga ülevool**
Segisti auk: **ilma aukudeta (5 x 35 mm altpoolt puuritud augud)**

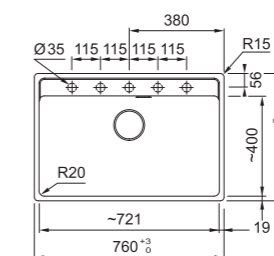

Manuaalventiil roostevabast terasest klapikaanega



Polaarvalge
114.0658.333
367.- €

Kivihall
114.0658.332
367.- €



Slate Grey
114.0715.518
367.- €

Cashmere
114.0658.334
367.- €

Onyx
114.0658.310
367.- €

Must matt
114.0658.331
381.- €



Selles versioonis on klapp, klappikate, ülevoolukate ja pöördnupp mattmustriga. Juhtseadme tüüp võib olenevalt mudelist erineda.

Musta pöördnupuga ekstsentriline klapp ja musta ülevoolukaitsega must ventiil



Must matt
114.0659.125
391.- €

Käsitsi 3½" ventiil musta klapi, ülevoolude ja klappikaanega



Must matt
114.0658.588
381.- €



MARIS

- 1
- 2
- 3
- 4
- 5

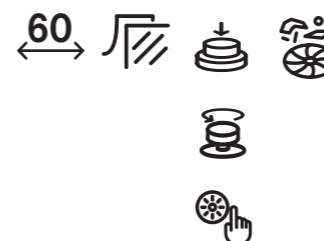

Mudel: **MRG 610-52A**
 Aluskapp: **60 cm**
 Mõõdud: **560 x 510 mm**
 Väljalõige: **540 x 498 mm (R=15 mm)**
 Kausi mõõtmed: **520 /400 /200 mm**
 Paigaldamine: **süvistatav**
 Materjal: **Fragranit**
 Ventii: **koos ventiiuga 3½"**
 Ventii juhtimine: **vajutusnupp või pöördnupp või käsitsi sõela avamine/sulgmine**
 Ventii kaas: **ümmargune**
 Ülevool: **katteplaadiga ülevool**
 Segisti auk: **ilma aukudeta (3 x 35 mm altpoolt puuritud augud)**

Ekstsentriline klapp ümmarguse terasest nupu ja roostevabast terasest klapikaanega

-  **Polaarvalge**
114.0658.296
330.- €
- Kivihall**
114.0658.295
330.- €
- NEW** **Slate Grey**
114.0715.519
330.- €
- Cashmere**
114.0658.297
330.- €
- Onyx**
114.0658.293
330.- €
- Must matt**
114.0658.294
344.- €

Lisad



- 112.0030.882
Rullmatt painduv
468 x 420 mm
82.- €
- 112.0188.651
Rv Mobiilne nõruti plastik raamis 342 x 430 x 22 mm
114.- €
- 112.0532.169
Roostevaba teras ventii kate 3½"
10.- €
- 112.0657.146
Must matt ventii kate 3½"
11.- €
- ALL-IN
5 erinevat komplekti ALL IN (rohkem lk 137) valamule: 340 x 540 mm
130.- ... 247.- €

MARIS

- 1
- 2
- 3
- 4
- 5



Mudel: **MRG 610-54A**
 Aluskapp: **60 cm**
 Mõõdud: **590 x 500 mm**
 Väljalõige: **570 x 480 mm (R=15 mm)**
 Kausi mõõtmed: **540 /400 /200 mm**
 Paigaldamine: **süvistatav**
 Materjal: **Fragranit**
 Ventii: **koos ventiiuga 3½"**
 Ventii juhtimine: **Ümmargune nupp klapiavade jaoks või käsitsi**
 Ventii kaas: **ümmargune**
 Ülevool: **katteplaadiga ülevool**
 Segisti auk: **ilma aukudeta (5 x 35 mm altpoolt puuritud augud)**

Ekstsentriline klapp ümmarguse terasest nupu ja roostevabast terasest klapikaanega

-  **Kivihall**
114.0658.495
331.- €
- Onyx**
114.0658.494
331.- €
- Must matt**
114.0658.493
345.- €

Manuaalventiil roostevabast terasest klapikaanega

-  **Kivihall**
114.0658.498
322.- €
- Onyx**
114.0658.497
322.- €
- Must matt**
114.0658.496
335.- €

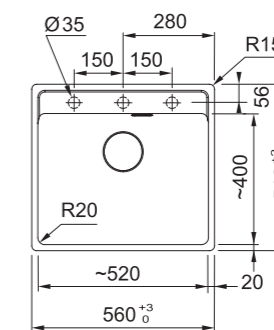

Manuaalventiil roostevabast terasest klapikaanega

-  **Polaarvalge**
114.0658.301
320.- €
- Kivihall**
114.0658.300
320.- €
- NEW** **Slate Grey**
114.0715.520
320.- €
- Cashmere**
114.0658.302
320.- €
- Onyx**
114.0658.298
320.- €
- Must matt**
114.0658.299
335.- €



Selles versioonis on klapp, klapiKate, ülevoolukate ja pöördnupp mattmus-tad. Juhtseadme tüüp võib olenevalt mudelist erineda.

Musta pöördnupuga ekstsentriline klapp ja musta ülevoolukaitsega must ventii

-  **Must matt**
114.0659.124
340.- €
- Must matt**
114.0658.586
335.- €

Käsitsi 3½" ventii musta klapi, ülevoolude ja klapikaanega

Maris



Lisad



112.0030.882
Rollmatt painduv
468 x 420 mm
82.- €

112.0188.651
Rv Mobiilne nõruti plastik
raamis 342 x 430 x 22 mm
114.- €

112.0532.169
Roostevaba teras ventiili
kate 3½"
10.- €

112.0657.146
Must matt ventiili kate 3½"
11.- €

ALL-IN
5 erinevat komplekti ALL IN
(rohkem lk 137) valamule:
340 x 540 mm
130.- ... 247.- €

MARIS

1
2
3
4
5



Mudel: **MRG 610-39A**
Aluskapp: **45 cm**
Mõõdud: **440 x 500 mm**
Väljalõige: **420 x 480 mm (R=15 mm)**
Kausi mõõtmed: **390 /400 /200 mm**
Paigaldamine: **süvistatav**
Materjal: **Fragranit**
Ventiil: **koos ventiiliga 3½"**
Ventiili juhtimine: **Ümmargune nupp klapiavade jaoks või käsitsi**
Ventiil kaas: **ümmargune**
Ülevool: **katteplaadiga ülevool**
Segisti auk: **ilma aukudeta (3 x 35 mm altpoolt puuritud augud)**

Kivihall
114.0658.419
285.- €

Onyx
114.0658.418
285.- €

Must matt
114.0658.417
299.- €

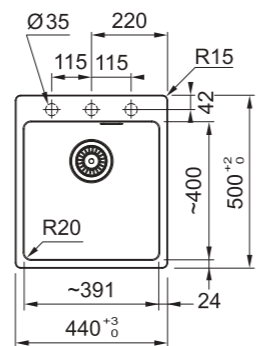

MARIS

1
2
3
4
5



Mudel: **MRG 610-37A**
Aluskapp: **45 cm**
Mõõdud: **410 x 510 mm**
Väljalõige: **390 x 498 mm (R=15 mm)**
Kausi mõõtmed: **370 /400 /200 mm**
Paigaldamine: **süvistatav**
Materjal: **Fragranit**
Ventiil: **koos ventiiliga 3½"**
Ventiili juhtimine: **vajutusnupp või pöördnupp või käsitsi sõela avamine/sulgemine**
Ventiil kaas: **ümmargune**
Ülevool: **katteplaadiga ülevool**
Segisti auk: **ilma aukudeta (3 x 35 mm altpoolt puuritud augud)**

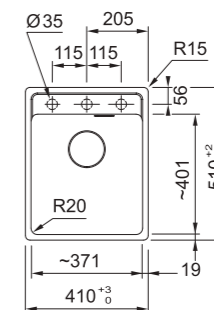
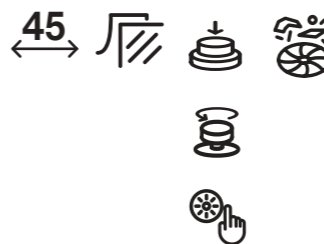

Ekstsentriline klapp ümmarguse terasest nupu ja roostevabast terasest klapikaanega

Polaarvalge
114.0658.256
284.- €

Kivihall
114.0658.255
284.- €

NEW Slate Grey
114.0715.521
284.- €

Cashmere
114.0658.257
284.- €

Onyx
114.0658.140
284.- €

Must matt
114.0658.254
298.- €

Manuaalventiil roostevabast terasest klapikaanega

Polaarvalge
114.0658.219
274.- €

Kivihall
114.0658.218
274.- €

NEW Slate Grey
114.0715.522
274.- €

Cashmere
114.0658.220
274.- €

Onyx
114.0658.216
274.- €

Must matt
114.0658.217
285.- €

Selles versioonis on klapp, klapiKate, ülevoolukate ja pöördnupp mattmustrad. Juhtseadme tüüp võib olenevalt mudelist erineda.

Musta pöördnupuga ekstsentriline klapp ja musta ülevoolukaitsega must ventiil

Must matt
114.0659.123
291.- €

Käsitsi 3½" ventiil musta klapi, ülevoolude ja klapikaanega

Must matt
114.0658.583
285.- €

Urban



Lisad



112.0595.334
Lõikelaud puit
532 x 280 mm
48.- €

2 ALL-IN
5 erinevat komplekti ALL IN
(rohkem lk 137) valamule:
340 x 540 mm
130.- ... 247.- €



115.0595.081
URBAN Onyx värvi segisti
209.- €



Mudel: **UBG 651-100**
Aluskapp: **60 cm**
Mõõdud: **1000 x 500 mm**
Väljalõige: **980 x 480 mm (R=15mm)**
Kausi mõõtmed: **350/425 /220 + 166/ 322 / 80 mm**
Paigaldamine: **süvistatav**
Kausi asukoht: **pööratav**
Materjal: **Fragranit**
Ventil: **nupuga avatav 3½" ventiil**
Ventili juhtimine: **Ümar keeratav nupp sõela avamiseks või sulgemiseks**
Ülevool: **katteplaadiga ülevool**
Segisti auk: **ilma aukudeta (2 x 35 mm altpoolt puuritud augud)**
Täiustatud töölaauaversioon: **min 30 mm paksune**
Tööpind tasapinnaline: **min 38 mm paksune**

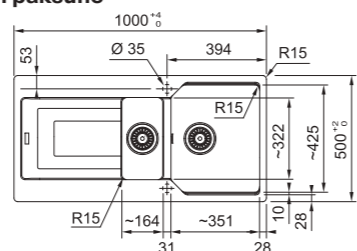

- Polaarvalge**
114.0682.526
350.- €
- Slate Grey**
114.0723.971
350.- €
- Kivihall**
114.0682.533
350.- €
- Cashmere**
114.0682.532
350.- €
- Onyx**
114.0682.534
350.- €

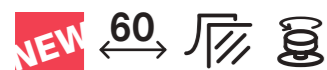

MARIS

1
2



Mudel: **UBG 611-100**
Aluskapp: **60 cm**
Mõõdud: **1000 x 500 mm**
Väljalõige: **980 x 480 mm (R=15mm)**
Kausi mõõtmed: **490/425 /220 mm**
Paigaldamine: **tasapinnaline või süvistatav**
Kausi asukoht: **pööratav**
Materjal: **Fragranit**
Ventil: **nupuga avatav 3½" ventiil**
Ventili juhtimine: **Ümar keeratav nupp sõela avamiseks või sulgemiseks**
Ülevool: **katteplaadiga ülevool**
Segisti auk: **ilma aukudeta (2 x 35 mm altpoolt puuritud augud)**
Täiustatud töölaauaversioon: **min 30 mm paksune**
Tööpind tasapinnaline: **min 38 mm paksune**

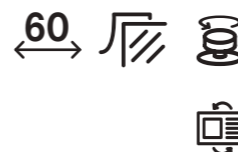
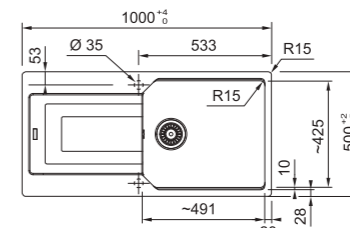

NEW

NEW

- Polaarvalge**
114.0682.525
367.- €
- Kivihall**
114.0682.529
367.- €
- Slate Grey**
114.0724.276
367.- €
- Cashmere**
114.0682.528
367.- €
- Onyx**
114.0682.530
367.- €
- Must matt**
114.0682.527
381.- €

MARIS

1
2



Mudel: **UBG 611-86**
Aluskapp: **50 cm**
Mõõdud: **860 x 500 mm**
Väljalõige: **840 x 480 mm (R=15mm)**
Kausi mõõtmed: **390/425 /220 mm**
Paigaldamine: **tasapinnaline või süvistatav**
Kausi asukoht: **pööratav**
Materjal: **Fragranit**
Ventil: **nupuga avatav 3½" ventiil**
Ventili juhtimine: **Ümar keeratav nupp sõela avamiseks või sulgemiseks**
Ülevool: **katteplaadiga ülevool**
Segisti auk: **ilma aukudeta (2 x 35 mm altpoolt puuritud augud)**
Täiustatud töölaauaversioon: **min 30 mm paksune**
Tööpind tasapinnaline: **min 38 mm paksune**

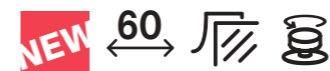
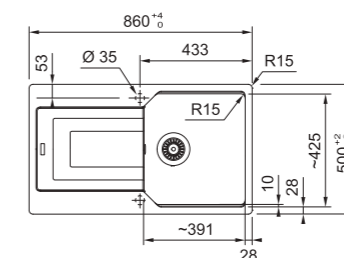

- Polaarvalge**
114.0682.510
323.- €
- Kivihall**
114.0682.523
323.- €
- Slate Grey**
114.0725.058
323.- €
- Cashmere**
114.0682.522
323.- €
- Onyx**
114.0682.524
323.- €
- Must matt**
114.0682.521
336.- €

MARIS

1
2



Mudel: **UBG 611-78**
Aluskapp: **45 cm**
Mõõdud: **780 x 500 mm**
Väljalõige: **760 x 480 mm (R=15mm)**
Kausi mõõtmed: **350/425 /220 mm**
Paigaldamine: **süvistatav**
Kausi asukoht: **pööratav**
Materjal: **Fragranit**
Ventil: **nupuga avatav 3½" ventiil**
Ventili juhtimine: **Ümar keeratav nupp sõela avamiseks või sulgemiseks**
Ülevool: **katteplaadiga ülevool**
Segisti auk: **ilma aukudeta (2 x 35 mm altpoolt puuritud augud)**
Täiustatud töölaauaversioon: **min 30 mm paksune**
Tööpind tasapinnaline: **min 38 mm paksune**

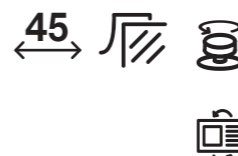
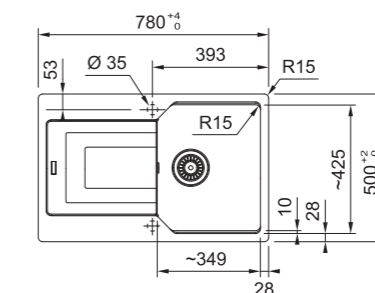

NEW

NEW

- Polaarvalge**
114.0682.550
315.- €
- Kivihall**
114.0682.563
315.- €
- Slate Grey**
114.0723.969
315.- €
- Cashmere**
114.0682.562
315.- €
- Onyx**
114.0682.564
315.- €
- Must matt**
114.0682.561
328.- €

Urban



Lisad



112.0595.334
Lõikelaud puit
532 x 280 mm
48.- €



ALL-IN
5 erinevat komplekti ALL IN
(rohkem lk 137) valamule:
340 x 540 mm
130.- ... 247.- €



115.0595.081
URBAN Onyx värvi segisti
209.- €



1
2

Mudel: UBG 611-78XL

Aluskapp: **60 cm**
Mõõdud: **780 x 500 mm**
Väljalõige: **760 x 480 mm (R=15mm)**
Kausi mõõtmed: **490/425 /220 mm**
Paigaldamine: **süvistatav**
Kausi asukoht: **pööratav**

Materjal: **Fragranit**

Ventiil: **nupuga avatav 3½" ventiil**

Ventiili juhtimine: **Ümar keeratav nupp sõela avamiseks või sulgemiseks**

Ülevool: **katteplaadiga ülevool**

Segisti auk: **ilma aukudeta (2 x 35 mm altpoolt puuritud augud)**

Täiustatud töölaauaversioon: **min 30 mm paksune**
Tööpind tasapinnaline: **min 38 mm paksune**

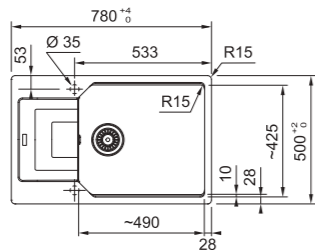

Ekstsentriline klapp ümmarguse terasest nupu ja roostevabast terasest klapikaanega

Polaarvalge
114.0682.565
315.- €

Kivihall
114.0682.569
315.- €

NEW **Slate Grey**
114.0723.970
315.- €

Cashmere
114.0682.567
315.- €

Onyx
114.0682.570
315.- €

NEW **Must matt**
114.0682.566
328.- €

Musta pöördnupuga ekstsentriline klapp ja musta ülevoolukaitsega must ventiil

NEW **Must matt**
114.0682.737
328.- €

MARIS

1
2



Mudel: UBG 611-62

Aluskapp: **45 cm**
Mõõdud: **620 x 500 mm**
Väljalõige: **600 x 480 mm (R=15mm)**
Kausi mõõtmed: **350/425 /220 mm**
Paigaldamine: **süvistatav**
Kausi asukoht: **pööratav**

Materjal: **Fragranit**

Ventiil: **nupuga avatav 3½" ventiil**

Ventiili juhtimine: **Ümar keeratav nupp sõela avamiseks või sulgemiseks**

Ülevool: **katteplaadiga ülevool**

Segisti auk: **ilma aukudeta (2 x 35 mm altpoolt puuritud augud)**

Täiustatud töölaauaversioon: **min 30 mm paksune**

Tööpind tasapinnaline: **min 38 mm paksune**

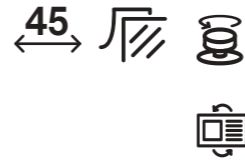
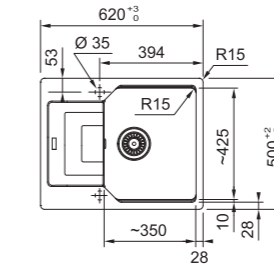

MARIS

1
2



Mudel: UBG 610-56

Aluskapp: **60 cm**
Mõõdud: **560 x 500 mm**
Väljalõige: **540 x 480 mm (R=15mm)**
Kausi mõõtmed: **503 /425 /220 mm**
Paigaldamine: **süvistatav**

Materjal: **Fragranit**

Ventiil: **nupuga avatav 3½" ventiil**

Ventiili juhtimine: **Ümar keeratav nupp sõela avamiseks või sulgemiseks**

Ülevool: **katteplaadiga ülevool**

Segisti auk: **ilma aukudeta (2 x 35 mm altpoolt puuritud augud)**

Täiustatud töölaauaversioon: **min 30 mm paksune**

Tööpind tasapinnaline: **min 38 mm paksune**

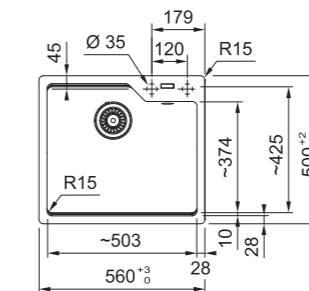

Ekstsentriline klapp ümmarguse terasest nupu ja roostevabast terasest klapikaanega

Polaarvalge
114.0682.600
320.- €

Kivihall
114.0682.643
320.- €

NEW **Slate Grey**
114.0723.966
320.- €

Cashmere
114.0682.642
320.- €

Onyx
114.0682.644
320.- €

NEW **Must matt**
114.0682.641
333.- €

Musta pöördnupuga ekstsentriline klapp ja musta ülevoolukaitsega must ventiil

NEW **Must matt**
114.0682.738
333.- €



Centro



Lisad



112.0595.334
Lõikelaud puit
532 x 280 mm
48.- €



2 ALL-IN
5 erinevat komplekti ALL IN
(rohkem lk 137) valamule:
340 x 540 mm
130.- ... 247.- €



115.0595.081
URBAN Onyx värvi segisti
209.- €

MARIS

1
2



Mudel: **CNG 611-86**
Aluskapp: **50 cm**
Mõõdud: **860 x 500 mm**
Väljalõige: **840 x 480 mm (R=15mm)**
Kausi mõõtmed: **392/435 /220 mm**
Paigaldamine: **tasapinnaline või süvistatav**
Kausi asukoht: **pööratav**
Materjal: **Fragranit**
Ventil: **nupuga avatav 3/2" ventiil**
Ventili juhtimine: **Ümar keeratav nupp sõela avamiseks või sulgemiseks**
Ülevool: **kattepladiga ülevool**
Segisti auk: **ilma aukudeta (2 x 35 mm altpoolt puuritud augud)**
Täiustatud töölauaversioon: **min 30 mm paksune**
Tööpind tasapinnaline: **min 38 mm paksune**

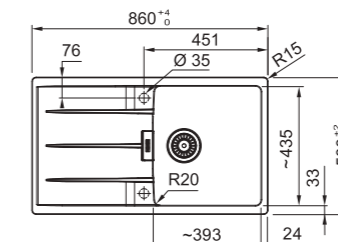

Polaarvalge
114.0682.501
370.- €

Kivihall
114.0682.459
370.- €

Slate Grey
114.0715.513
370.- €

Cashmere
114.0682.502
370.- €

Onyx
114.0682.458
370.- €

Must matt
114.0682.460
384.- €

NEW

MARIS

1
2



Mudel: **CNG 611-78**
Aluskapp: **45 cm**
Mõõdud: **780 x 500 mm**
Väljalõige: **760 x 480 mm (R=15mm)**
Kausi mõõtmed: **342 /435 /200 mm**
Paigaldamine: **tasapinnaline või süvistatav**
Materjal: **Fragranit**
Ventil: **nupuga avatav 3/2" ventiil**
Ventili juhtimine: **Ümar keeratav nupp sõela avamiseks või sulgemiseks**
Ülevool: **kattepladiga ülevool**
Segisti auk: **ilma aukudeta (2 x 35 mm altpoolt puuritud augud)**
Täiustatud töölauaversioon: **min 30 mm paksune**
Tööpind tasapinnaline: **min 38 mm paksune**

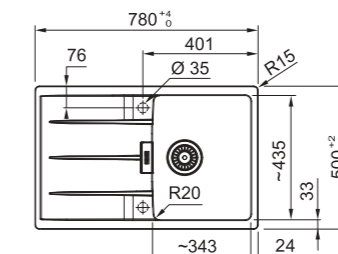

Polaarvalge
114.0681.585
342.- €

Kivihall
114.0681.583
342.- €

Slate Grey
114.0715.514
342.- €

Cashmere
114.0681.586
342.- €

Onyx
114.0681.581
342.- €

Must matt
114.0681.584
356.- €

NEW

MARIS

1
2



Mudel: **CNG 611-62**
Aluskapp: **45 cm**
Mõõdud: **620 x 500 mm**
Väljalõige: **600 x 480 mm (R=15mm)**
Kausi mõõtmed: **342 /435 /200 mm**
Paigaldamine: **tasapinnaline või süvistatav**
Materjal: **Fragranit**
Ventil: **nupuga avatav 3/2" ventiil**
Ventili juhtimine: **Ümar keeratav nupp sõela avamiseks või sulgemiseks**
Ülevool: **kattepladiga ülevool**
Segisti auk: **ilma aukudeta (2 x 35 mm altpoolt puuritud augud)**
Täiustatud töölauaversioon: **min 30 mm paksune**
Tööpind tasapinnaline: **min 38 mm paksune**

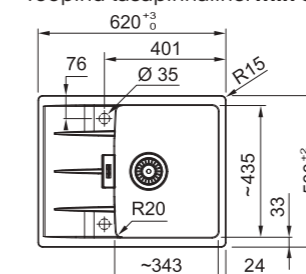

Polaarvalge
114.0681.429
314.- €

Kivihall
114.0681.427
314.- €

Slate Grey
114.0715.515
314.- €

Cashmere
114.0681.430
314.- €

Onyx
114.0681.426
314.- €

Must matt
114.0681.428
328.- €

NEW

Basis



Lisad



112.0595.334
Lõikelaud puit
532 x 280 mm
48.- €



2 ALL-IN
5 erinevat komplekti ALL-IN
(rohkem lk 137) valamule:
340 x 540 mm
130.- ... 247.- €



3 112.0473.656
Augufrees 35mm Fragranit
valamutele Ø35 mm
5.- €

MARIS

1
2
3



Mudel: **BFG 651**
Aluskapp: **60 cm**
Mõõdud: **970 x 500 mm**
Väljalõige: **950 x 480 mm (R=12mm)**
Kausi mõõtmed: **340 /420 /200 + 150 /290 /90 mm**
Paigaldamine: **süvistatav**
Kausi asukoht: **pööratav**
Materjal: **Fragranit**
Ventil: **nupuga avatav 3½" ventiil**
Ventili juhtimine: **Ümar keeratav nupp sõela avamiseks või sulgemiseks**
Ülevool: **katteplaadiga ülevool**
Segisti auk: **ilma aukudeta (4 x 35 mm altpoolt puuritud augud)**
Tööpind: **min 30 mm paksune**
Komplekti iekjauta: **Roostevabast terasest nõrutuskauss 112.0250.014**

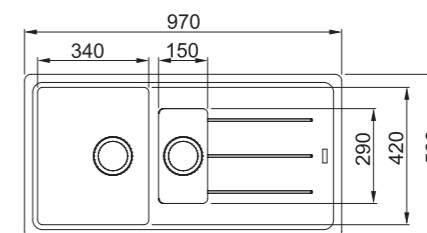

Polaarvalge
114.0256.626
363.- €

Kivihall
114.0256.627
363.- €

Slate Grey
114.0723.973
363.- €

Beež
114.0256.624
363.- €

Cashmere
114.0301.961
363.- €

Onyx
114.0256.625
363.- €

NEW

MARIS

1
2
3



Mudel: **BFG 651-78**
Aluskapp: **60 cm**
Mõõdud: **780 x 500 mm**
Väljalõige: **760 x 480 mm (R=12mm)**
Kausi mõõtmed: **340 /420 /200 + 150 /290 /90 mm**
Paigaldamine: **süvistatav**
Kausi asukoht: **pööratav**
Materjal: **Fragranit**
Ventil: **nupuga avatav 3½" ventiil**
Ventili juhtimine: **Ümar keeratav nupp sõela avamiseks või sulgemiseks**
Ülevool: **katteplaadiga ülevool**
Segisti auk: **ilma aukudeta (4 x 35 mm altpoolt puuritud augud)**
Tööpind: **min 30 mm paksune**
Komplekti iekjauta: **Roostevabast terasest nõrutuskauss 112.0250.014**

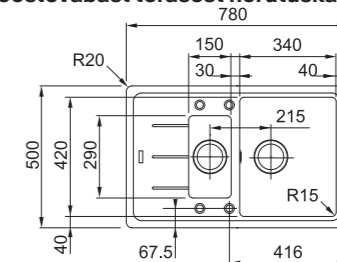

Polaarvalge
114.0301.368
330.- €

Kivihall
114.0301.367
330.- €

Slate Grey
114.0723.961
330.- €

Beež
114.0301.370
330.- €

Cashmere
114.0301.951
330.- €

Onyx
114.0301.345
330.- €

NEW

MARIS

1
2
3



Mudel: **BFG 611-86**
Aluskapp: **45 cm**
Mõõdud: **860 x 500 mm**
Väljalõige: **840 x 480 mm (R=12mm)**
Kausi mõõtmed: **340 /420 /200 mm**
Paigaldamine: **süvistatav**
Kausi asukoht: **pööratav**
Materjal: **Fragranit**
Ventil: **nupuga avatav 3½" ventiil**
Ventili juhtimine: **Ümar keeratav nupp sõela avamiseks või sulgemiseks**
Ülevool: **katteplaadiga ülevool**
Segisti auk: **ilma aukudeta (2 x 35 mm altpoolt puuritud augud)**
Tööpind: **min 30 mm paksune**

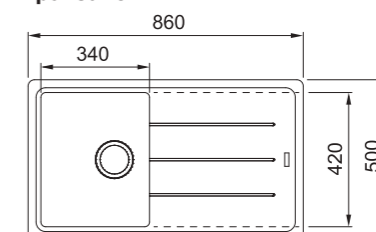

Kivihall
114.0336.936
293.- €

Slate Grey
114.0723.959
293.- €

Beež
114.0336.914
293.- €

Cashmere
114.0336.916
293.- €

Onyx
114.0336.939
293.- €

NEW

Basis



Lisad



112.0595.334
Lõikelaud puit
532 x 280 mm
48.- €



2 ALL-IN
5 erinevat komplekti ALL-IN
(rohkem lk 137) valamule:
340 x 540 mm
130.- ... 247.- €



3 112.0473.656
Augufrees 35mm Fragranit
valamutele Ø35 mm
5.- €

MARIS

1
2
3



Mudel: **BFG 611**
Aluskapp: **45 cm**
Mõõdud: **780 x 500 mm**
Väljalõige: **760 x 480 mm (R=12mm)**
Kausi mõõtmed: **340 /420 /200 mm**
Paigaldamine: **süvistatav**
Kausi asukoht: **pööratav**
Materjal: **Fragranit**
Ventil: **nupuga avatav 3½" ventiil**
Ventili juhtimine: **Ümar keeratav nupp sõela avamiseks või sulgemiseks**
Ülevool: **katteplaadiga ülevool**
Segisti auk: **ilma aukudeta (2 x 35 mm altpoolt puuritud augud)**
Tööpind: **min 30 mm paksune**

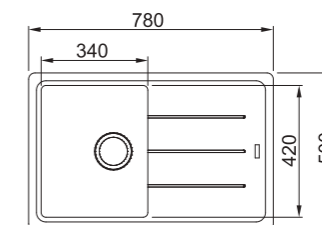

Polaarvalge
114.0256.611
280.- €

Kivihall
114.0256.612
280.- €

Slate Grey
114.0723.958
280.- €

Beež
114.0256.609
280.- €

Cashmere
114.0301.907
280.- €

Onyx
114.0256.610
280.- €

MARIS

1
2
3



Mudel: **BFG 611-62**
Aluskapp: **45 cm**
Mõõdud: **620 x 500 mm**
Väljalõige: **600 x 480 mm (R=12mm)**
Kausi mõõtmed: **340 /420 /200 mm**
Paigaldamine: **süvistatav**
Kausi asukoht: **pööratav**
Materjal: **Fragranit**
Ventil: **nupuga avatav 3½" ventiil**
Ventili juhtimine: **Ümar keeratav nupp sõela avamiseks või sulgemiseks**
Ülevool: **katteplaadiga ülevool**
Segisti auk: **ilma aukudeta (4 x 35 mm altpoolt puuritud augud)**
Tööpind: **min 30 mm paksune**

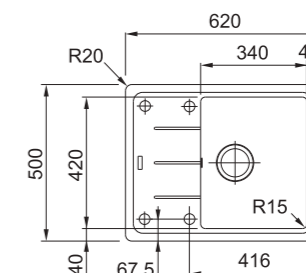

Polaarvalge
114.0301.335
267.- €

Kivihall
114.0301.333
267.- €

Slate Grey
114.0723.957
267.- €

Beež
114.0301.342
267.- €

Cashmere
114.0301.903
267.- €

Onyx
114.0301.331
267.- €

MARIS

1
2
3



Mudel: **BFG 620**
Aluskapp: **80 cm**
Mõõdud: **860 x 500 mm**
Väljalõige: **840 x 480 mm (R=12mm)**
Kausi mõõtmed: **2x 337 /420 /200 mm**
Paigaldamine: **süvistatav**
Materjal: **Fragranit**
Ventil: **nupuga avatav 3½" ventiil**
Ventili juhtimine: **Ümar keeratav nupp sõela avamiseks või sulgemiseks**
Ülevool: **katteplaadiga ülevool**
Segisti auk: **ilma aukudeta (2 x 35 mm altpoolt puuritud augud)**
Tööpind: **min 30 mm paksune**

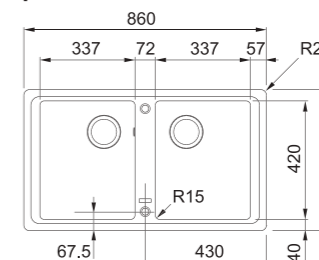
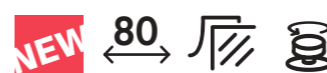

Slate Grey
114.0723.972
329.- €

Beež
114.0302.018
329.- €

Onyx
114.0301.373
329.- €

Must matt
114.0657.823
342.- €

Strata



Lisad



ALL-IN
5 erinevat komplekti ALL IN
(rohkem lk 137) valamule:
340 x 540 mm
130.- ... 247.- €



115.0623.057
ORBIT Onyx värvi segisti
168.- €

SMART

1



Mudel: **STG 614**

Aluskapp: **45 cm**

Mõõdud: **860 x 435 mm**

Väljalõige: **840 x 415 mm (R=20mm)**

Kausi mõõtmed: **333 / 360 / 165 mm**

Paigaldamine: **süvistatav**

Kausi asukoht: **pööratav**

Materjal: **Fragranit**

Ventiil: **manuaalne 3½" ventiil**

Ventiili juhtimine: **põhjasõela käsitsi avamine**

Ülevool: **katteplaadiga ülevool**

Segisti auk: **ilma aukudeta (2 x 35 mm altpoolt puuritud augud)**

Tööpind: **min 30 mm paksune**

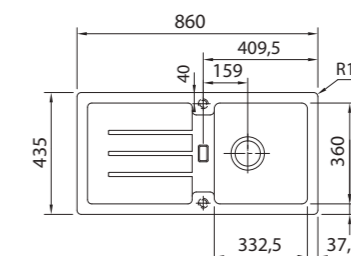

NEW

Kivihall
114.0197.797
243.- €

Slate Grey
114.0723.989
243.- €

Beež
114.0302.757
243.- €

Onyx
114.0302.751
243.- €

SMART

1



Mudel: **STG 614-78**

Aluskapp: **45 cm**

Mõõdud: **780 x 435 mm**

Väljalõige: **760 x 415 mm (R=20mm)**

Kausi mõõtmed: **333 / 360 / 165 mm**

Paigaldamine: **süvistatav**

Kausi asukoht: **pööratav**

Materjal: **Fragranit**

Ventiil: **manuaalne 3½" ventiil**

Ventiili juhtimine: **põhjasõela käsitsi avamine**

Ülevool: **katteplaadiga ülevool**

Segisti auk: **ilma aukudeta (2 x 35 mm altpoolt puuritud augud)**

Tööpind: **min 30 mm paksune**

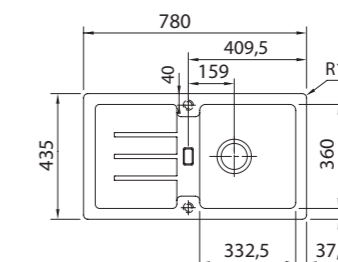

NEW

Polaarvalge
114.0303.670
233.- €

Kivihall
114.0303.671
233.- €

NEW

Slate Grey
114.0723.986
233.- €

Beež
114.0303.672
233.- €

Onyx
114.0303.666
233.- €

NEW

Must matt
114.0657.828
247.- €

Ronda



Mudel: **ROG 611**
 Aluskapp: **45 cm**
 Mõõdud: **770 x 500 mm**
 Väljalõige: **Šablooni järgi**
 Kausi mõõtmed: **Ø 410 /195 mm**
 Paigaldamine: **süvistatav**
 Kausi asukoht: **pööratav**
 Materjal: **Fragranit**
 Ventii: **nupuga või manuaalne 3½" ventiil**
 Ventili juhtimine: **Ümar keeratav nupp sõela avamiseks või sulgemiseks või põhjasõela käsitsi avamine**
 Segisti auk: **ilma aukudeta (2 x 35 mm altpoolt puuritud augud)**
 Tööpind: **min 30 mm paksune**

Ventiil 3½" nupuga
 **Beež**
 114.0031.171
245.- €

Manuaalne 3½" ventiil
 **Beež**
 114.0029.528
227.- €

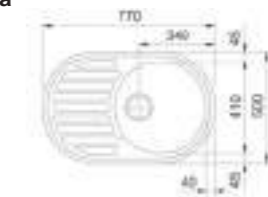

Mudel: **ROG 611-62**
 Aluskapp: **45 cm**
 Mõõdud: **620 x 500 mm**
 Väljalõige: **Šablooni järgi**
 Kausi mõõtmed: **Ø 410 /195 mm**
 Paigaldamine: **süvistatav**
 Kausi asukoht: **pööratav**
 Materjal: **Fragranit**
 Ventii: **manuaalne 3½" ventiil**
 Ventili juhtimine: **põhjasõela käsitsi avamine**
 Segisti auk: **ilma aukudeta (2 x 35 mm altpoolt puuritud augud)**
 Tööpind: **min 30 mm paksune**

Beež
 114.0316.528
222.- €

Onyx
 114.0316.526
222.- €

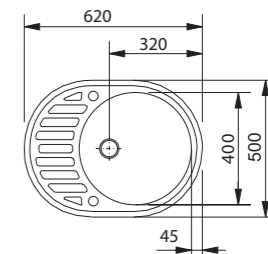

Mudel: **ROG 610-41**
 Aluskapp: **45 cm**
 Mõõdud: **Ø 510 mm**
 Väljalõige: **Ø 493 mm**
 Kausi mõõtmed: **Ø 400 /195 mm**
 Paigaldamine: **süvistatav**
 Materjal: **Fragranit**
 Ventii: **nupuga või manuaalne 3½" ventiil**
 Ventili juhtimine: **Ümar keeratav nupp sõela avamiseks või sulgemiseks või põhjasõela käsitsi avamine**
 Segisti auk: **35 mm auk + augu jaoks eelnevalt puuritud koht**
 Tööpind: **min 30 mm paksune**

Ventiil 3½" nupuga
 **Polaarvalge**
 114.0009.509
213.- €

Kivihall
 114.0009.505
213.- €

Slate Grey
 114.0723.992
213.- €

Beež
 114.0009.506
213.- €

Onyx
 114.0199.717
213.- €

NEW



Manuaalne 3½" ventiil
 **Polaarvalge**
 114.0009.546
194.- €

Kivihall
 114.0009.542
194.- €

Slate Grey
 114.0723.965
194.- €

Beež
 114.0009.543
194.- €

Onyx
 114.0199.718
194.- €

Must matt
 114.0700.628
208.- €

NEW

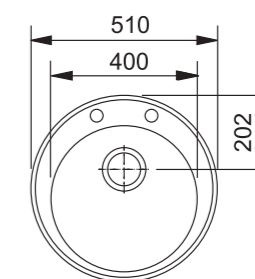

Tectonite valamud



92
95

Sirius
Single



Tectonite valamud



Aluskapp 60 cm



S2D 651
94. lk.



S2D 611-100
95. lk.



S2D 611-78XL
95. lk.



SID 610
96. lk.

Aluskapp 50 cm



S2D 611-78
95. lk.

Aluskapp 45 cm



S2D 611-62
96. lk.



SID 610-40
96. lk.



SINGLE
97. lk.

SMART

Sirius Tectonite



Lisad



112.0512.280
Plastikust nõrutuskauss hall
456 x 179 x 92 mm
23.- €

112.0595.334
Lõikelaud puit
532 x 280 mm
48.- €

ALL-IN
5 erinevat komplekti ALL IN
(rohkem lk 137) valamule:
340 x 540 mm
130.- ... 247.- €

SMART



Mudel: **S2D 651**
Aluskapp: **60 cm**
Mõõdud: **1000 x 500 mm**
Väljalõige: **984 x 484 mm (R = 7,5 mm)**
Kausi mõõtmed: **350 / 432 / 200 + 150 / 350 / 150 mm**
Paigaldamine: **süvistatav**
Kausi asukoht: **pööratav**
Materjal: **Tectonite**
Ventil: **manuaalne 3½" ventiil**
Ventili juhtimine: **põhjasõela käsitsi avamine**
Ülevool: **katteplaadiga ülevool**
Segisti auk: **erinev**
Tööpind: **min 30 mm paksune**

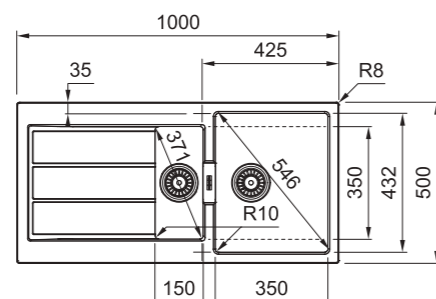

Valamu ilma segisti
aukudeta

Arktiline valge
143.0615.781
213.- €

Urban grey
143.0615.785
213.- €

Carbon
143.0615.629
213.- €

Valamu mõlemal
küljel 2 segisti
avaga. Kasutamata
augu saab katta
112.0006.333

Beež
143.0670.834
213.- €

112.0006.333
Roostevabast terasest vala-
mu käsifrees 35 mm augu
jaoks
3.- €

SMART



Mudel: **S2D 611-100**
Aluskapp: **60 cm**
Mõõdud: **1000 x 500 mm**
Väljalõige: **984 x 484 mm (R = 7,5 mm)**
Kausi mõõtmed: **450 / 432 / 200 mm**
Paigaldamine: **süvistatav**
Kausi asukoht: **pööratav**
Materjal: **Tectonite**
Ventil: **manuaalne 3½" ventiil**
Ventili juhtimine: **põhjasõela käsitsi avamine**
Ülevool: **katteplaadiga ülevool**
Segisti auk: **ilma aukudeta**
Tööpind: **min 30 mm paksune**

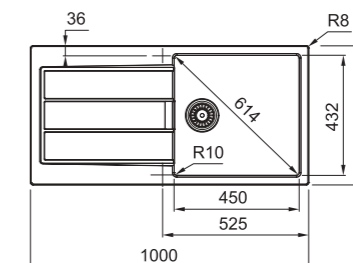

Arktiline valge
143.0590.205
180.- €

Urban grey
143.0590.207
180.- €

Beež
143.0670.831
180.- €

Carbon
143.0590.212
180.- €

SMART



Mudel: **S2D 611-78**
Aluskapp: **50 cm**
Mõõdud: **780 x 500 mm**
Väljalõige: **764 x 484 mm (R = 7,5 mm)**
Kausi mõõtmed: **350 / 432 / 200 mm**
Paigaldamine: **süvistatav**
Kausi asukoht: **pööratav**
Materjal: **Tectonite**
Ventil: **manuaalne 3½" ventiil**
Ventili juhtimine: **põhjasõela käsitsi avamine**
Ülevool: **katteplaadiga ülevool**
Segisti auk: **ilma aukudeta**
Tööpind: **min 30 mm paksune**

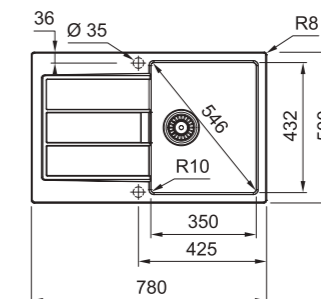

Arktiline valge
143.0590.159
165.- €

Urban grey
143.0590.191
165.- €

Carbon
143.0590.196
165.- €

SMART



Mudel: **S2D 611-78XL**
Aluskapp: **60 cm**
Mõõdud: **780 x 500 mm**
Väljalõige: **764 x 484 mm (R = 7,5 mm)**
Kausi mõõtmed: **440 / 432 / 200 mm**
Paigaldamine: **süvistatav**
Kausi asukoht: **pööratav**
Materjal: **Tectonite**
Ventil: **manuaalne 3½" ventiil**
Ventili juhtimine: **põhjasõela käsitsi avamine**
Ülevool: **katteplaadiga ülevool**
Segisti auk: **ilma aukudeta**
Tööpind: **min 30 mm paksune**

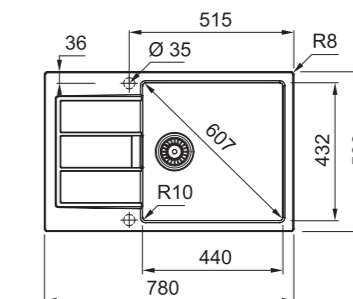

Arktiline valge
143.0590.221
165.- €

Urban grey
143.0590.223
165.- €

Beež
143.0670.832
165.- €

Carbon
143.0590.228
165.- €

Sirius Tectonite

SMART

1
2
3



Mudel: **S2D 611-62**
 Aluskapp: **45 cm**
 Mõõdud: **620 x 500 mm**
 Väljalõige: **604 x 484 mm (R = 7,5 mm)**
 Kausi mõõtmed: **343 /432 /200 mm**
 Paigaldamine: **süvistatav**
 Kausi asukoht: **pööratav**
 Materjal: **Tectonite**
 Ventii: **manuaalne 3½" ventii**
 Ventii juhtimine: **põhjasõela käsitsi avamine**
 Ülevool: **kattepladiga ülevool**
 Segisti auk: **ilma aukudeta**
 Tööpind: **min 30 mm paksune**

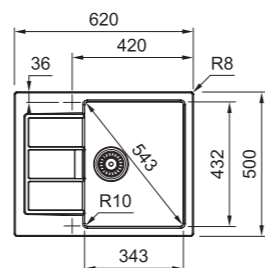

Arktiline valge
 143.0616.341
157.- €

Urban grey
 143.0616.345
157.- €

Beež
 143.0670.833
157.- €

Carbon
 143.0616.339
157.- €

SMART

3



Mudel: **SID 610**
 Aluskapp: **60 cm**
 Mõõdud: **560 x 530 mm**
 Väljalõige: **540 x 510 mm**
 Kausi mõõtmed: **490 /370 /200 mm**
 Paigaldamine: **süvistatav**
 Materjal: **Tectonite**
 Ventii: **manuaalne 3½" ventii**
 Ventii juhtimine: **põhjasõela käsitsi avamine**
 Ülevool: **kattepladiga ülevool**
 Segisti auk: **35 mm auk**
 Tööpind: **min 30 mm paksune**

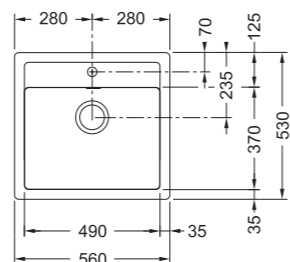

Arktiline valge
 114.0368.449
165.- €

Urban grey
 114.0463.958
165.- €

Beež
 143.0675.481
165.- €

Carbon
 114.0368.467
165.- €

SMART

3



Mudel: **SID 610-40**
 Aluskapp: **45 cm**
 Mõõdud: **430 x 530 mm**
 Väljalõige: **410 x 510 mm**
 Kausi mõõtmed: **371 /385 /200 mm**
 Paigaldamine: **süvistatav**
 Materjal: **Tectonite**
 Ventii: **manuaalne 3½" ventii**
 Ventii juhtimine: **põhjasõela käsitsi avamine**
 Ülevool: **kattepladiga ülevool**
 Segisti auk: **35 mm auk**
 Tööpind: **min 30 mm paksune**

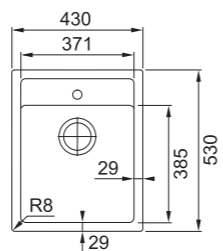

Arktiline valge
 114.0499.970
154.- €

Urban grey
 114.0500.012
154.- €

Beež
 143.0675.501
154.- €

Carbon
 114.0500.019
154.- €

Lisad

1



112.0512.280
 Plastikust nõrutuskauss hall
 456 x 179 x 92 mm
 23.- €

2



112.0595.334
 Lõikelaud puit
 532 x 280 mm
 48.- €

3



ALL-IN
 5 erinevat komplekti ALL IN
 (rohkem lk 137) valamule:
 340 x 540 mm
 130.- ... 247.- €

Single Tectonite



SMART



Mudel: **SINGLE 1**
 Aluskapp: **45 cm**
 Mõõdud: **Ø 500 mm**
 Väljalõige: **Ø 480 mm**
 Kausi mõõtmed: **Ø 400 /150 mm**
 Paigaldamine: **süvistatav**
 Materjal: **Tectonite**
 Ventii: **manuaalne 3½" ventii**
 Ventii juhtimine: **põhjasõela käsitsi avamine**
 Segisti auk: **35 mm auk**
 Tööpind: **min 30 mm paksune**

Arktiline valge
 114.0463.691
117.- €

Urban grey
 114.0463.698
117.- €

Beež
 143.0675.484
117.- €

Carbon
 114.0463.694
117.- €

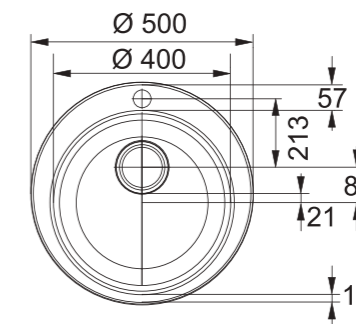

Keraamilised valamud



99
101

Mythos
Belfast





Lisad

1



112.0256.867
Rullmatt painduv
298 x 410 mm
45.- €

MYTHOS

1



Mudel: **MTK 651-100**
Aluskapp: **60 cm**
Mõõdud: **1000 x 510 mm**
Väljalõige: **individuaalne**
Kausi mõõtmed: **340 / 372 / 190 + 157 / 372 / 120 mm**
Paigaldamine: **süvistatav**
Materjal: **Fraceram**
Ventil: **Sealhulgas ventiil 3½" vajutusnupuga**
Ventili juhtimine: **PushKnob Vajutusnupp ümmargune roostevaba teras (tööpinnale on vajalik auk 35mm)**
Ventil väikese kausi jaoks: **Ventiil 1½" mittersulguv**
Ülevool: **katteplaadiga ülevool**
Segisti auk: **segisti ja nupu jaoks 2x 35 mm auk**



Suur kaus paremal



Valge
124.0335.709
956.- €

Onyx
124.0335.868
956.- €

Suur kaus vasakul



Valge
124.0335.710
956.- €

Onyx
124.0335.872
956.- €

Tähelepanu mõõdud!
Keraamilise valamu mõõdud võivad tehnoloogiast tulenevalt erineda joonistel toodud mõõtudest. Seepärast soovitame väljalõige tööpinda teha konkreetse valamu mõõtude järgi. Samuti on keraamilisel valamul lubatud minimaalne kõverus

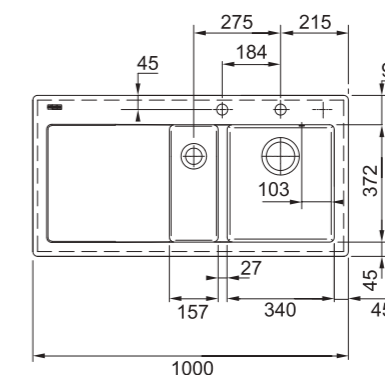

Mythos



Lisad



112.0030.882
Rullmatt paindub
468 x 420 mm
83.- €

MYTHOS

1



Mudel: **MTK 611-100**
Aluskapp: **60 cm**
Mõõdud: **1000 x 510 mm**
Väljalõige: **individuaalne**
Kausi mõõtmed: **492 / 372 / 190 mm**
Paigaldamine: **süvistatav**
Materjal: **Fraceram**
Ventiil: **Sealhuigas ventiil 3½" vajutusnupuga**
Ventiili juhtimine: **PushKnob Vajutusnupp ümmargune roostevaba teras (tööpinnale on vajalik auk 35mm)**
Ülevool: **katteplaadiga ülevool**
Segisti auk: **segisti ja nupu jaoks 2x 35 mm auk**

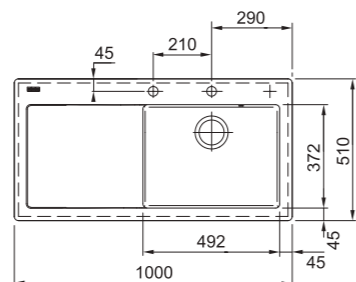

Suur kaus paremal



Valge
124.0335.707
900.- €

Antratsiit matt
124.0380.247
900.- €

Onyx
124.0335.856
900.- €

Suur kaus vasakul



Valge
124.0335.708
900.- €

Antratsiit matt
124.0380.248
900.- €

Onyx
124.0335.863
900.- €

Tähelepanu mõõdud!
Keraamilise valamü mõõdud võivad tehnoloogiast tulenevalt erineda joonistel toodud mõõtudest. Seepärast soovime väljalõige tööpinda teha konkreetse valamü mõõtude järgi. Samuti on keraamilisel valamul lubatud minimaalne kõverus

Mythos

MYTHOS

1



Mudel: **MTK 610-58**
Aluskapp: **60 cm**
Mõõdud: **580 x 510 mm**
Väljalõige: **individuaalne**
Kausi mõõtmed: **490 / 377 / 190 mm**
Paigaldamine: **süvistatav**
Materjal: **Fraceram**
Ventiil: **sealhuigas ventiil 3½" vajutusnupuga**
Ventiili juhtimine: **Vajutusnupp ümmargune roostevaba teras**
Ülevool: **katteplaadiga ülevool**
Segisti auk: **segisti ja nupu jaoks 2x 35 mm auk**

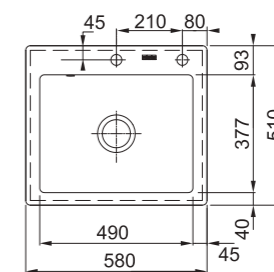

Valge
124.0335.706
593.- €

Magnolia
124.0335.844
593.- €

Onyx
124.0335.851
593.- €

Antratsiit matt
124.0380.250
593.- €

Belfast



Mudel: **BAK 710**
Aluskapp: **60 cm**
Mõõdud: **595 x 475 mm**
Kausi mõõtmed: **545 / 410 / 200 mm**
Paigaldamine: **kapile paigaldatav valamü**
Materjal: **Fraceram**
Ventiil: **manuaalne 3½" ventiil**
Ventiili juhtimine: **põhjasõela käsitsi avamine**
Segisti auk: **ilma**

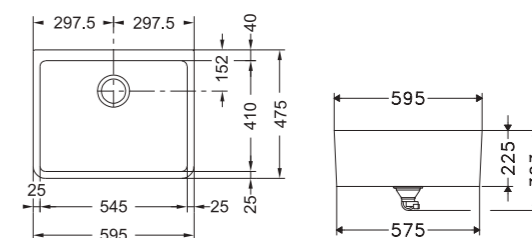

Tähelepanu mõõdud!
Keraamilise valamü mõõdud võivad tehnoloogiast tulenevalt erineda joonistel toodud mõõtudest. Seepärast soovime väljalõige tööpinda teha konkreetse valamü mõõtude järgi. Samuti on keraamilisel valamul lubatud minimaalne kõverus

Valge
130.0085.739
482.- €

Altpoolt monteeritavad valamud



- 104
- 106
- 108
- 110
- 112
- 116
- 119
- 120
- 121
- 122
- 124
- 134

- Ülevaade
- Mythos Masterpiece
- Mythos
- Maris Quiet
- Franke Box
- Maris
- Aton
- Smart
- Epos
- Kubus 2
- Maris
- Kubus Fraceram



Altpoolt monteeri-

tavad valamud

Roostevabast terasest valamud



BXM 210/110-50
107. lk.



BXM 210/110-40
107. lk.



MYX 110-50
109. lk.



MYX 110-45
109. lk.



MQX 110-82
111. lk.



BXX 210/110-68
112. lk.



BXX 210/110-54
113. lk.



MRX 110-70
117. lk.



MRX 110-55
117. lk.



MRX 160-34-19
116. lk.



MQX 110-50
111. lk.



BXX 210/110-50
113. lk.



MRX 110-50
117. lk.



BXX 210/110-45
113. lk.



BXX 210/110-40
114. lk.



MRX 110-45
117. lk.



MRX 110-40
118. lk.



BXX 210/110-34
115. lk.



MRX 110-34
118. lk.



EOX 110-50
121. lk.



EOX 110-45
121. lk.



BXX 110-16
115. lk.



ANX 110-48
119. lk.



SRX 110-50
120. lk.



ANX 110-34
119. lk.

Fragranit valamud



KNG 110-62
123. lk.



KNG 110-52
123. lk.



KNG 110-37
123. lk.



MRG 110-72
124. lk.



MRG 110-52
125. lk.



MRG 110-37
127. lk.



MRG 110-72 A
128. lk.



MRG 110-52 A
129. lk.



MRG 110-37 A
129. lk.

Keraamilised valamud



KBK 110-70
135. lk.



KBK 160
134. lk.



KBK 110-50
135. lk.



KBK 110-40
135. lk.

Tasapinnaline



Süvistatavaid valamuid saab paigaldada ainult niiskuskindlatele pindadele ja selleks on vaja vastavaid tööriistu. Enne süvistatava valamü ostmist palun veenduge, et köögitootja oskab sellist montaaži teha ja tööpind oleks ka sellele vastav.



MRG 210-72
130. lk.



MRG 210-72 A
131. lk.



MRG 210-52 A
132. lk.



MRG 210-34 A
133. lk.

MYTHOS

MARIS

SMART

Mythos Masterpiece



MYTHOS



BXM 210/110-50

Aluskapp: 60 cm
Mõõdud: 540 x 450 mm
Väljalõige: 510 x 420 mm (R = 10 mm)
Kausi mõõtmed: 500 /410 /200 mm
Paigaldamine: SlimTop, tasapinnaline või altpool
Materjal: F-Inox roostevara teras
Ventil: eksentriline või manuaalne 3½" ventiil
Ventili juhtimine: Vajutusnupp ümmargune roostevara teras
Ülevool: katteplaadiga ülevool
Tööpind: min paksus 12 mm



Lisatarvikud, mis kuuluvad komplekti: Tavaline metallrest valamule, valamü värvid (A1, G1 või C1)

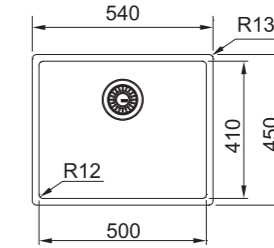
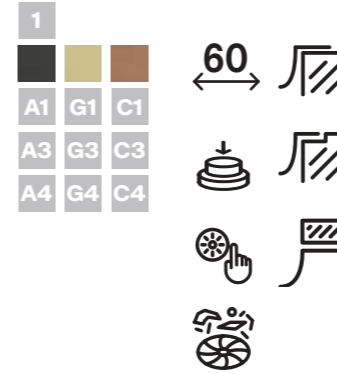

Nupuga juhitud eksentrilklapiga valamü.



Antratsiit*
127.0650.363 *
1293.- €

Šampanjakuldne*
127.0662.540 *
1293.- €

Vask*
127.0662.642 *
1293.- €

Valamü käsitsi ventiiliga, mida saab tösta/langetada manuaalselt



Antratsiit*
127.0672.129 *
1151.- €

Šampanjakuldne*
127.0674.362 *
1151.- €

Vask*
127.0674.363 *
1151.- €

* - Küsi saadavust oma Franke partnerilt

Lisad

Antratsiit	1 112.0676.854 Plastikust lõikepind 240 x 429 x 15 mm 169.- €	A1 112.0655.470 Tavaline metallrest kraanikausile Antratsiit 491 x 401 mm (50 cm valamud) 194.- €	A2 112.0655.431 Tavaline metallrest kraanikausile Antratsiit 391 x 401 mm (40 cm valamud) 155.- €	A3 112.0655.239 Nõrutuskauss- roostevara teras Antratsiit 157 x 429 x 54 mm 162.- €	A4 112.0655.342 Rullmatt paindub Antratsiit 468 x 440 mm 291.- €
Šampanjakuldne	1 112.0676.854 Plastikust lõikepind 240 x 429 x 15 mm 169.- €	G1 112.0655.471 Tavaline metallrest kraanikausile Šampanjakuldne 491 x 401 mm (50 cm valamud) 194.- €	G2 112.0655.433 Tavaline metallrest kraanikausile Šampanjakuldne 391 x 401 mm (40 cm valamud) 155.- €	G3 112.0655.240 Nõrutuskauss- roostevara teras Šampanjakuldne 157 x 429 x 54 mm 162.- €	G4 112.0655.343 Rullmatt paindub Šampanjakuldne 468 x 440 mm 291.- €
Vask	1 112.0676.854 Plastikust lõikepind 240 x 429 x 15 mm 169.- €	C1 112.0655.472 Tavaline metallrest kraanikausile vask 491 x 401 mm (50 cm valamud) 194.- €	C2 112.0655.468 Tavaline metallrest kraanikausile vask 391 x 401 mm (40 cm valamud) 155.- €	C3 112.0655.341 Nõrutuskauss- roostevara teras vask 157 x 429 x 54 mm 162.- €	C4 112.0655.344 Rullmatt paindub vask 468 x 440 mm 291.- €

Ühilduvad tooted



Mythos Masterpiece segistid
rohkem 147. lk.



Atlas Neo segistid
rohkem 154. lk.



Eos Neo segistid
rohkem 157. lk.



Atlas Neo seebidosaatid
rohkem 178. lk.

MYTHOS



BXM 210/110-40

Aluskapp: 45 cm
Mõõdud: 440 x 450 mm
Väljalõige: 410 x 420 mm (R = 10 mm)
Kausi mõõtmed: 400 /410 /200 mm
Paigaldamine: SlimTop, tasapinnaline või altpool
Materjal: F-Inox roostevara teras
Ventil: eksentriline või manuaalne 3½" ventiil
Ventili juhtimine: Vajutusnupp ümmargune roostevara teras
Ülevool: katteplaadiga ülevool
Tööpind: min paksus 12 mm



Lisatarvikud, mis kuuluvad komplekti: Tavaline metallrest valamule, valamü värvid (A2, G2 või C2)

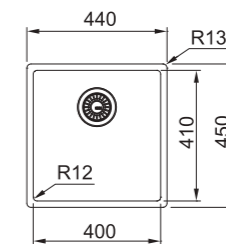

Nupuga juhitud eksentrilklapiga valamü.



Antratsiit*
127.0650.362 *
1206.- €

Šampanjakuldne*
127.0662.648 *
1206.- €

Vask*
127.0662.649 *
1206.- €

Valamü käsitsi ventiiliga, mida saab tösta/langetada manuaalselt



Antratsiit*
127.0674.537 *
1065.- €

Šampanjakuldne*
127.0674.582 *
1065.- €

Vask*
127.0674.583 *
1065.- €

* - Küsi saadavust oma Franke partnerilt



MYTHOS



- 1
- 2
- 3
- 4

Mudel: **MYX 110-50**
 Aluskapp: **60 cm**
 Mõõdud: **540 x 440 mm (R = 10 mm)**
 Väljalõige: **500 x 400 mm (R = 25 mm)**
 Kausi mõõtmed: **500 / 400 / 200 mm (R = 25 mm)**
 Paigaldamine: **altpoolt monteeritav**
 Materjal: **roostevaba teras poleeritud**
 Ventii: **integreeritud ventiil**
 Ventili juhtimine: **Vajutusnupp ümmargune roostevaba teras**
 Nupu kasutamiseks on vaja 35 mm auku
 Ülevool: **katteplaadiga ülevool**

MYX 110-50
 122.0601.316
 603.- €

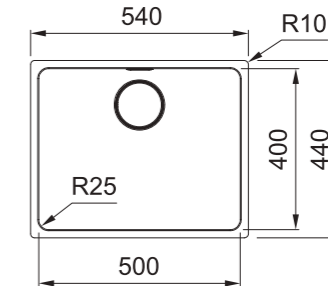

MYTHOS



- 1
- 2
- 3
- 4

Mudel: **MYX 110-45**
 Aluskapp: **50 cm**
 Mõõdud: **490 x 440 mm (R = 10 mm)**
 Väljalõige: **450 x 400 mm (R = 25 mm)**
 Kausi mõõtmed: **450 / 400 / 200 mm (R = 25 mm)**
 Paigaldamine: **altpoolt monteeritav**
 Materjal: **roostevaba teras poleeritud**
 Ventii: **integreeritud ventiil**
 Ventili juhtimine: **Vajutusnupp ümmargune roostevaba teras**
 Nupu kasutamiseks on vaja 35 mm auku
 Ülevool: **katteplaadiga ülevool**

MYX 110-45
 122.0601.315
 581.- €

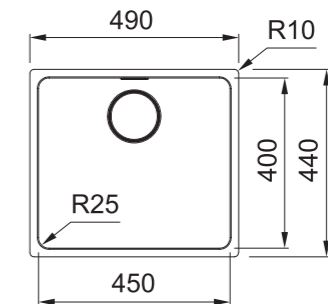

Lisad

1



112.0591.082
 Lõikelaud kivipaber kiitkivi
 180 x 412 mm
 115.- €

2



112.0591.081
 Rullmatt paindub
 252 x 424 mm
 65.- €

3



112.0602.288
 Rv Mobiilne nõruti plastik
 raamis 298 x 412 mm
 104.- €

4



112.0659.398
 Roostevabast terasest
 nõrutuskauss plastkäepide-
 metega
 159 x 416 x 54 mm
 63.- €



115.0529.207
 Eos Neo U roostevabast
 terasest segistid
 325.- €

Maris Quiet



Müravaene, loovuserohke

Et kodus veedetud aeg oleks meeldivalt rahulik, on kraanikauss varustatud meie ainulaadse Quiet Pad-süsteemi ehk kahekordse kattekihiga, mis vähendab müra 20% ja võimaldab nautida toiduvalmistamist maksimaalse rahuga.

Ohutu ja kvaliteetne

Maris Quiet Bowl pole mitte ainult vaikne, vaid ka hügieeniline ja ohutu. Selle 7-tolline Big Waste Kit kogub kõik jäätmed ning hoiab ära ummistumise ja soovimatud lõhnad, võimaldades ise valmistatud õhtusööki nautides täies rahus.



MARIS

1
2
3



Mudel: **MQX 110-82**
Aluskapp: **90 cm**
Mõõdud: **860 x 460 mm (R = 40 mm)**
Väljalõige: **820 x 424 mm (R = 20mm)**
Kausi mõõtmed: **820 / 420 / 190 mm (R = 20 mm)**
Paigaldamine: **altpoolt monteeritav**
Materjal: **roostevaba teras poleeritud**
Ventil: **162 mm prügi väljalaskeava läbimõõt, suur sangadega prügikorb muudab jäätmete ja kinnijäänud toidu äraviskamise lihtsaks**
Ülevool: **katteplaadiga ülevool**

NEW

MQX 110-82
122.0694.479
679.- €

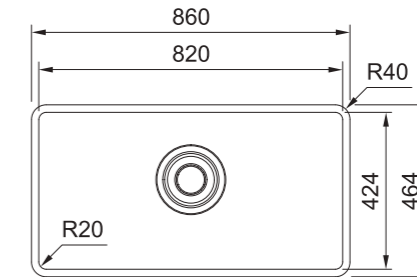
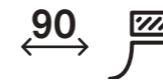

MARIS

1
2
3



Mudel: **MQX 110-50**
Aluskapp: **60 cm**
Mõõdud: **540 x 440 mm (R = 40 mm)**
Väljalõige: **500 x 400 mm (R = 20mm)**
Kausi mõõtmed: **500 / 400 / 188 mm (R = 20 mm)**
Paigaldamine: **altpoolt monteeritav**
Materjal: **roostevaba teras poleeritud**
Ventil: **162 mm prügi väljalaskeava läbimõõt, suur sangadega prügikorb muudab jäätmete ja kinnijäänud toidu äraviskamise lihtsaks**
Ülevool: **katteplaadiga ülevool**

NEW

MQX 110-50
122.0694.477
559.- €

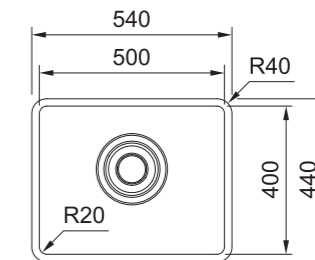
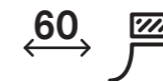

Lisad

1



ALL-IN
5 erinevat komplekti ALL IN
(rohkem lk 137) valamule:
340 x 540 mm
130.- ... 247.- €

2



112.0071.973
Sifoonikomplekt Ø40 mm
ühendusega
15.- €

3



112.0277.144
Universaalne ülevoolu ühen-
duskomplekt
27.- €



Läbipaistev jäätmekate



162 mm prügi väljalaskeava läbimõõt



Suur sangadega prügikorb muudab jäätmete ja kinnijäänud toidu äraviskamise lihtsaks



Lisad

- | | | | |
|--|---|--|--|
| 1 | 2 | 3 | 4 |
| | | | |
| 112.0080.355
Rollmatt paindub
468 x 440 mm
86.- € | 112.0204.360
Rv Mobiilne nõruti plastik
raamis 326 x 440 x 23 mm
124.- € | 112.0394.981
Roostevabast terasest
nõrutuskauss plastkäepide-
metega
429 x 156 mm
110.- € | 112.0619.946
Andy Chef - tarvikute
komplekt
408 x 133 x 200 mm
471.- € |

MARIS

- 1
- 2
- 3
- 4



Mudel: **BXX 210/110-68**
Aluskapp: **80 cm**
Mõõdud: **725 x 450 mm**
Väljalõige: **695 x 420 mm (R = 10 mm)**
Kausi mõõtmed: **685 / 410 / 200 mm**
Paigaldamine: **SlimTop, tasapinnaline või altpool**
Materjal: **roostevaba teras poleeritud**
Ventiiil: **integreeritud või 3½" ventiil**
Ventiiili juhtimine: **Vajutusnupp ümmargune roostevaba teras**
Nupu kasutamiseks on vaja 35 mm auku
Ülevool: **katteplaadiga ülevool**
Tööpind: **min paksus 12 mm**

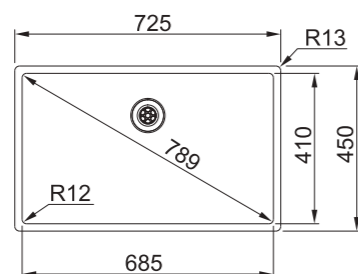

Valamu põhjaga integreeritud ekstsentrilapiga valamuga, mida juhitakse nupuga.

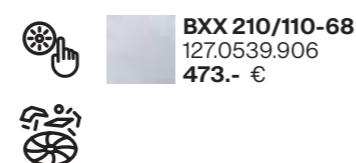
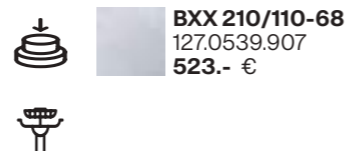

BXX 210/110-68
127.0539.907
523.- €

Valamu käsitsi ventiiliga, mida saab tõsta/langetada manuaalselt. Täienduste hulgas on ka jäätmepurustusmasinad.

BXX 210/110-68
127.0539.906
473.- €

MARIS

- 1
- 2
- 3
- 4



Mudel: **BXX 210/110-45**
Aluskapp: **50 cm**
Altpoolt monteeritav aluskapp: **60 cm**
Mõõdud: **490 x 450 mm**
Väljalõige: **460 x 420 mm (R = 10 mm)**
Kausi mõõtmed: **450 / 410 / 200 mm**
Paigaldamine: **SlimTop, tasapinnaline või altpool**
Materjal: **roostevaba teras poleeritud**
Ventiiil: **integreeritud või 3½" ventiil**
Ventiiili juhtimine: **Vajutusnupp ümmargune roostevaba teras**
Nupu kasutamiseks on vaja 35 mm auku
Ülevool: **katteplaadiga ülevool**
Tööpind: **min paksus 12 mm**

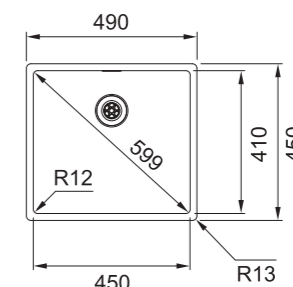

Valamu põhjaga integreeritud ekstsentrilapiga valamuga, mida juhitakse nupuga.

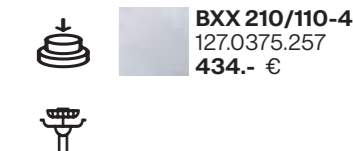

Valamu käsitsi ventiiliga, mida saab tõsta/langetada manuaalselt. Täienduste hulgas on ka jäätmepurustusmasinad.

BXX 210/110-45
127.0372.489
380.- €

MARIS

- 1
- 2
- 3
- 4



Mudel: **BXX 210/110-50**
Aluskapp: **60 cm**
Mõõdud: **540 x 450 mm**
Väljalõige: **510 x 420 mm (R = 10 mm)**
Kausi mõõtmed: **500 / 410 / 200 mm**
Paigaldamine: **SlimTop, tasapinnaline või altpool**
Materjal: **roostevaba teras poleeritud**
Ventiiil: **integreeritud või 3½" ventiil**
Ventiiili juhtimine: **Vajutusnupp ümmargune roostevaba teras**
Nupu kasutamiseks on vaja 35 mm auku
Ülevool: **katteplaadiga ülevool**
Tööpind: **min paksus 12 mm**

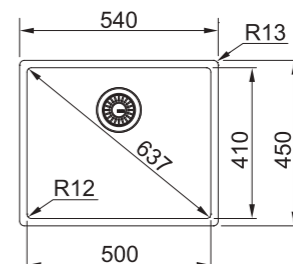

Valamu põhjaga integreeritud ekstsentrilapiga valamuga, mida juhitakse nupuga.

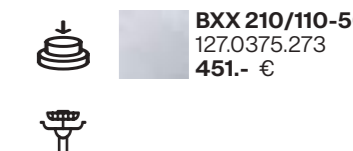

Valamu käsitsi ventiiliga, mida saab tõsta/langetada manuaalselt. Täienduste hulgas on ka jäätmepurustusmasinad.

BXX 210/110-50
127.0374.206
396.- €

MARIS

- 1
- 2
- 3
- 4



Mudel: **BXX 210/110-54**
Aluskapp: **60 cm**
Altpoolt monteeritav aluskapp: **80 cm**
Mõõdud: **580 x 450 mm**
Väljalõige: **550 x 420 mm (R = 10 mm)**
Kausi mõõtmed: **540 / 410 / 200 mm**
Paigaldamine: **SlimTop, tasapinnaline või altpool**
Materjal: **roostevaba teras poleeritud**
Ventiiil: **integreeritud või 3½" ventiil**
Ventiiili juhtimine: **Vajutusnupp ümmargune roostevaba teras**
Nupu kasutamiseks on vaja 35 mm auku
Ülevool: **katteplaadiga ülevool**
Tööpind: **min paksus 12 mm**

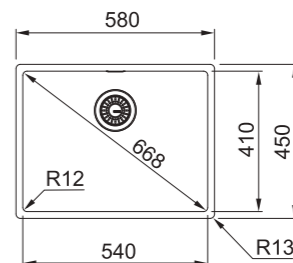

Valamu põhjaga integreeritud ekstsentrilapiga valamuga, mida juhitakse nupuga.

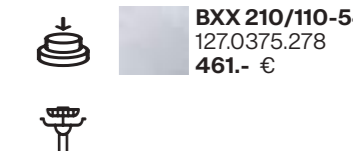

Valamu käsitsi ventiiliga, mida saab tõsta/langetada manuaalselt. Täienduste hulgas on ka jäätmepurustusmasinad.

BXX 210/110-54
127.0375.278
461.- €



Box



Lisad

- | | | | |
|--|---|--|--|
| 1 | 2 | 3 | 4 |
| | | | |
| 112.0080.355
Rullmatt paindub
468 x 440 mm
86.- € | 112.0204.360
Rv Mobiilne nõruti plastik
raamis 326 x 440 x 23 mm
124.- € | 112.0394.981
Roostevabast terasest
nõrutuskauss plastkäepide-
metega
429 x 156 mm
110.- € | 112.0619.946
Andy Chef - tarvikute
komplekt
408 x 133 x 200 mm
471.- € |

MARIS



- 1
- 2
- 3
- 4



Mudel: **BXX 210/110-40**
 Aluskapp: **45 cm**
 Altpoolt monteeritav aluskapp: **50 cm**
 Mõõdud: **440 x 450 mm**
 Väljalõige: **410 x 420 mm (R = 10 mm)**
 Kausi mõõtmed: **400 /410 /200 mm**
 Paigaldamine: **SlimTop, tasapinnaline või altpoolt**
 Materjal: **roostevaba teras poleeritud**
 Ventiiil: **integreeritud või 3½" ventiil**
 Ventiiili juhtimine: **Vajutusnupp ümmargune roostevaba teras**
 Nupu kasutamiseks on vaja 35 mm auku
 Ülevool: **katteplaadiga ülevool**
 Tööpind: **min paksus 12 mm**

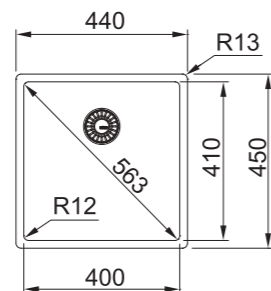

Valamu põhjaga integreeritud ekstsentrilapiga valamu, mida juhitakse nupuga.

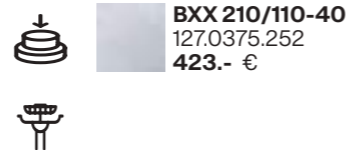

Valamu käsitsi ventiiliga, mida saab tõsta/langetada manuaalselt. Täienduste hulgas on ka jäätmepurustusmasinad.

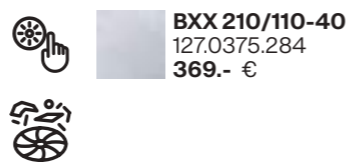

BXX 210/110-40
127.0375.252
423.- €

BXX 210/110-40
127.0375.284
369.- €

MARIS



- 1
- 2
- 3
- 4



Mudel: **BXX 210/110-34**
 Aluskapp: **40 cm**
 Altpoolt monteeritav aluskapp: **45 cm**
 Mõõdud: **380 x 450 mm**
 Väljalõige: **350 x 420 mm (R = 10 mm)**
 Kausi mõõtmed: **340 /410 /200 mm**
 Paigaldamine: **SlimTop, tasapinnaline või altpoolt**
 Materjal: **roostevaba teras poleeritud**
 Ventiiil: **manuaalne 3½" ventiil**
 Ventiiili juhtimine: **põhjasõela käsitsi avamine**
 Nupu kasutamiseks on vaja 35 mm auku
 Ülevool: **katteplaadiga ülevool**
 Tööpind: **min paksus 12 mm**

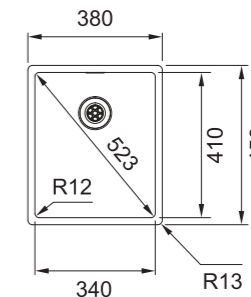

Valamu põhjaga integreeritud ekstsentrilapiga valamu, mida juhitakse nupuga.

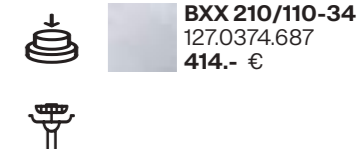

Valamu käsitsi ventiiliga, mida saab tõsta/langetada manuaalselt. Täienduste hulgas on ka jäätmepurustusmasinad.

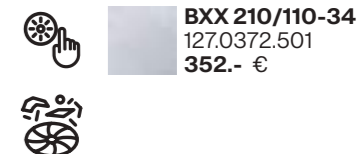

BXX 210/110-34
127.0374.687
414.- €

BXX 210/110-34
127.0372.501
352.- €

MARIS



- 1
- 3
- 4



Mudel: **BXX 210/110-16**
 Aluskapp: **30 cm**
 Mõõdud: **200 x 450 mm**
 Väljalõige: **170 x 420 mm (R = 10 mm)**
 Kausi mõõtmed: **160 /410 /200 mm**
 Paigaldamine: **altpoolt monteeritav**
 Materjal: **roostevaba teras poleeritud**
 Ventiiil: **integreeritud ventiil**
 Ventiiili juhtimine: **Vajutusnupp ümmargune roostevaba teras**
 Nupu kasutamiseks on vaja 35 mm auku
 Ülevool: **katteplaadiga ülevool**
 Tööpind: **min paksus 12 mm**

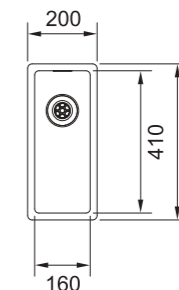

Valamu põhjaga integreeritud ekstsentrilapiga valamu, mida juhitakse nupuga.

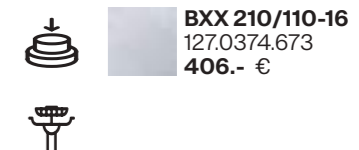

BXX 210/110-16
127.0374.673
406.- €

Andy Chef



Maris



Lisad



1
ALL-IN
5 erinevat komplekti ALL IN (rohkem lk 137)
valamule: 340 x 540 mm
130.- ... 247.- €



2
112.0030.882
Rullmatt paindub
468 x 420 mm
83.- €



3
112.0188.651
Rv Mobiilne nõruti plastik
raamis
342 x 430 x 22 mm
114.- €



1
2
3

Mudel: **MRX 160-34-19**
Aluskapp: **60 cm**
Mõõdud: **595 x 440 mm**
Väljalõige: **555 x 400 mm (R=16mm)**
Kausi mõõtmed: **340/400/180 + 190/400/130 mm**
Paigaldamine: **altpoolt monteeritav**
Materjal: **roostevaba teras poleeritud**
Ventil: **manuaalne 3½" ventiil**
Ventili juhtimine: **käsi avamine/ sulgemine**
Ülevool: **katteplaadiga ülevool**
Tööpind: **min paksus 20 mm**

MRX 160-34-19
122.0594.258
571.- €

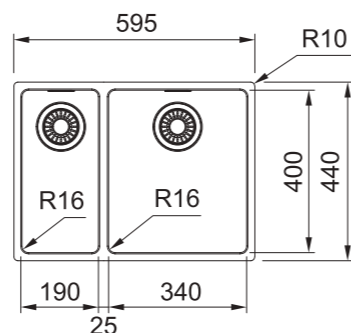

MARIS



1
2
3

Mudel: **MRX 110-70**
Aluskapp: **80 cm**
Mõõdud: **740 x 440 mm**
Väljalõige: **700 x 400 mm (R=16mm)**
Kausi mõõtmed: **700/400/180 mm**
Paigaldamine: **altpoolt monteeritav**
Materjal: **roostevaba teras poleeritud**
Ventil: **manuaalne 3½" ventiil**
Ventili juhtimine: **käsi avamine/ sulgemine**
Ülevool: **katteplaadiga ülevool**
Tööpind: **min paksus 20 mm**

MRX 110-70
122.0531.911
372.- €

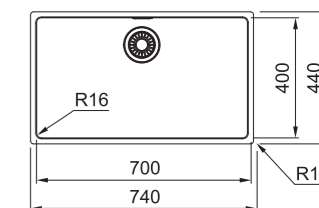

MARIS



1
2
3

Mudel: **MRX 110-55**
Aluskapp: **80 cm**
Mõõdud: **590 x 440 mm**
Väljalõige: **550 x 400 mm (R=16mm)**
Kausi mõõtmed: **550/400/180 mm**
Paigaldamine: **altpoolt monteeritav**
Materjal: **roostevaba teras poleeritud**
Ventil: **manuaalne 3½" ventiil**
Ventili juhtimine: **käsi avamine/ sulgemine**
Ülevool: **katteplaadiga ülevool**
Tööpind: **min paksus 20 mm**

MRX 110-55
122.0553.947
315.- €

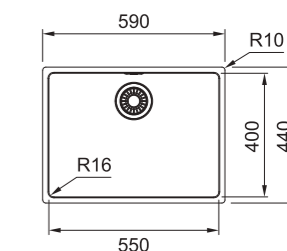

MARIS



1
2
3

Mudel: **MRX 110-50**
Aluskapp: **60 cm**
Mõõdud: **540 x 440 mm**
Väljalõige: **500 x 400 mm (R=16mm)**
Kausi mõõtmed: **500/400/180 mm**
Paigaldamine: **altpoolt monteeritav**
Materjal: **roostevaba teras poleeritud**
Ventil: **manuaalne 3½" ventiil**
Ventili juhtimine: **käsi avamine/ sulgemine**
Ülevool: **katteplaadiga ülevool**
Tööpind: **min paksus 20 mm**

MRX 110-50
122.0531.808
302.- €

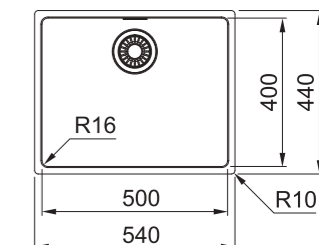

MARIS



1
2
3

Mudel: **MRX 110-45**
Aluskapp: **50 cm**
Mõõdud: **490 x 440 mm**
Väljalõige: **450 x 400 mm (R=16mm)**
Kausi mõõtmed: **450/400/180 mm**
Paigaldamine: **altpoolt monteeritav**
Materjal: **roostevaba teras poleeritud**
Ventil: **manuaalne 3½" ventiil**
Ventili juhtimine: **käsi avamine/ sulgemine**
Ülevool: **katteplaadiga ülevool**
Tööpind: **min paksus 20 mm**

MRX 110-45
122.0553.943
290.- €

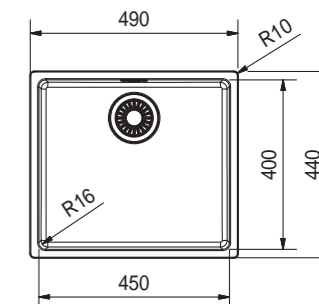



Lisad



1
ALL-IN
5 erinevat komplekti ALL IN (rohkem lk 137) valamule: 340 x 540 mm
130.- ... 247.- €



2
112.0030.882
Rullmatt paindud
468 x 420 mm
83.- €



3
112.0188.651
Rv Mobiilne nõruti plastik raamis
342 x 430 x 22 mm
114.- €

MARIS



1
2
3

Mudel: **MRX 110-40**
Aluskapp: **50 cm**
Mõõdud: **440 x 440 mm**
Väljalõige: **400 x 400 mm (R=16mm)**
Kausi mõõtmed: **400/400/180 mm**
Paigaldamine: **altpoolt monteeritav**
Materjal: **roostevaba teras poleeritud**
Ventiil: **manuaalne 3½" ventiil**
Ventiili juhtimine: **käsitsi avamine/ sulgemine**
Ülevool: **katteplaadiga ülevool**
Tööpind: **min paksus 20 mm**

MRX 110-40
122.0531.643
277.- €

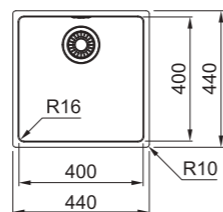

MARIS



1
2

Mudel: **ANX 110-48**
Aluskapp: **60 cm**
Mõõdud: **510 x 430 mm**
Väljalõige: **Sablooni järgi**
Kausi mõõtmed: **480 /400 /190 mm**
Paigaldamine: **altpoolt monteeritav**
Materjal: **roostevaba teras poleeritud**
Ventiil: **nupuga avatav 3½" ventiil**
Ventiili juhtimine: **Ventiili juhtimine tõstenupp (auk 18mm)**
Ülevool: **katteplaadiga ülevool**
Tööpind: **min paksus 20 mm**

ANX 110-48
122.0336.883
204.- €

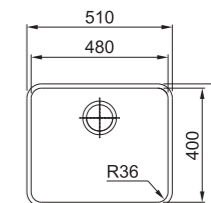

MARIS



1
2
3

Mudel: **MRX 110-34**
Aluskapp: **45 cm**
Mõõdud: **380 x 440 mm**
Väljalõige: **340 x 400 mm (R=16mm)**
Kausi mõõtmed: **340/400/180 mm**
Paigaldamine: **altpoolt monteeritav**
Materjal: **roostevaba teras poleeritud**
Ventiil: **manuaalne 3½" ventiil**
Ventiili juhtimine: **käsitsi avamine/ sulgemine**
Ülevool: **katteplaadiga ülevool**
Tööpind: **min paksus 20 mm**

MRX 110-34
122.0531.850
269.- €

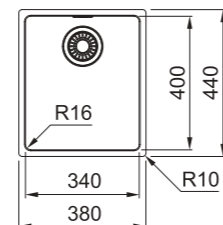

MARIS



1
2

Mudel: **ANX 110-34**
Aluskapp: **45 cm**
Mõõdud: **370 x 430 mm**
Väljalõige: **Sablooni järgi**
Kausi mõõtmed: **340 /400 /190 mm**
Paigaldamine: **altpoolt monteeritav**
Materjal: **roostevaba teras poleeritud**
Ventiil: **nupuga avatav 3½" ventiil**
Ventiili juhtimine: **Ventiili juhtimine tõstenupp (auk 18mm)**
Ülevool: **katteplaadiga ülevool**
Tööpind: **min paksus 20 mm**

ANX 110-34
122.0336.885
190.- €

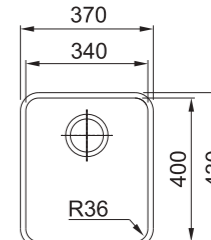



Lisad



ALL-IN
5 erinevat komplekti ALL IN (rohkem lk 137) valamule: 340 x 540 mm
130.- ... 247.- €

MARIS



Mudel: **EOX 110-50**
Aluskapp: **60 cm**
Mõõdud: **530 x 440 mm**
Väljalõige: **497 x 407 mm (R = 48,5 mm)**
Kausi mõõtmed: **500 /410 /175 mm**
Paigaldamine: **altpoolt monteeritav**
Materjal: **roostevaba teras poleeritud**
Ventiiil: **integreeritud ventiiil**
Ülevool: **katteplaadiga ülevool**

EOX 110-50
122.0197.991
284.- €

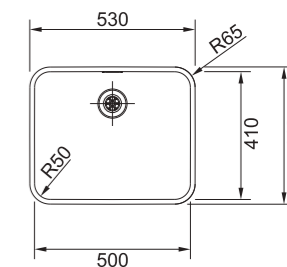

SMART



Mudel: **SRX 110-50**
Aluskapp: **60 cm**
Mõõdud: **541 x 441 mm**
Väljalõige: **500 x 400 mm (R = 60 mm)**
Kausi mõõtmed: **500 /400 /180 mm**
Paigaldamine: **altpoolt monteeritav**
Materjal: **roostevaba teras poleeritud**
Ventiiil: **koos ventiiiliga 3 1/2"**
Ventiiili juhtimine: **käsitsi avamine/ sulgemine**

SRX 110-50
127.0708.304
186.- €

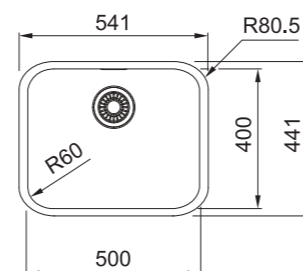

MARIS



Mudel: **EOX 110-45**
Aluskapp: **50 cm**
Mõõdud: **470 x 415 mm**
Väljalõige: **442 x 387 mm (R = 48,5 mm)**
Kausi mõõtmed: **445 /390 /175 mm**
Paigaldamine: **altpoolt monteeritav**
Materjal: **roostevaba teras poleeritud**
Ventiiil: **integreeritud ventiiil**
Ülevool: **katteplaadiga ülevool**

EOX 110-45
122.0197.995
264.- €

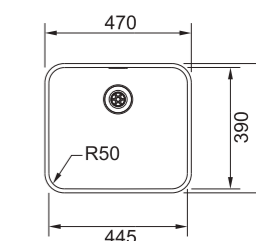

Kubus 2



Lisad



112.0066.060
Roostevabast terasest nõrutuskauss plastkäepidemetega
156 x 417 x 54 mm
110.- €

112.0256.867
Rollmatt paindub
298 x 410 mm
45.- €

112.0204.360
Rv Mobiilne nõruti plastik raamis
326 x 440 x 23 mm
124.- €

112.0654.748
Riektlõikelaud puit
442 x 230 x 23 mm
75.- €



MYTHOS

1
2
3
4



Mudel: **KNG 110-62**
Aluskapp: **80 cm**
Mõõdud: **760 x 460 mm**
Väljalõige: **720 x 420 mm (R=10 mm)**
Kausi mõõtmed: **620 /420 /200 mm**
Paigaldamine: **altpoolt monteeritav**
Kausi asukoht: **pööratav**
Materjal: **Fragranit**
Ventil: **sealhulgas ventiil 3½" vajutusnupuga**
Ventili juhtimine: **Vajutusnupp ümmargune roostevaba teras**
Ventil kaas: **Katteplaadiga ülevool**
Ülevool: **katteplaadiga ülevool**
Segisti auk: **ilma aukudeta (2 x 35 mm altpoolt puuritud augud)**
Erimärkused: **2-tasandilise kausi tarvikud**

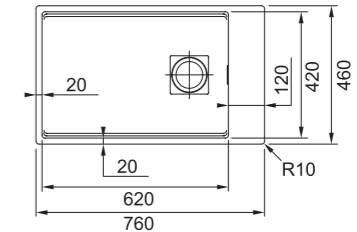

MYTHOS

1
2
3
4



Mudel: **KNG 110-52**
Aluskapp: **60 cm**
Mõõdud: **560 x 460 mm**
Väljalõige: **520 x 420 mm (R=10 mm)**
Kausi mõõtmed: **520 /420 /200 mm**
Paigaldamine: **altpoolt monteeritav**
Materjal: **Fragranit**
Ventil: **sealhulgas ventiil 3½" vajutusnupuga**
Ventili juhtimine: **Vajutusnupp ümmargune roostevaba teras**
Ventil kaas: **Katteplaadiga ülevool**
Ülevool: **katteplaadiga ülevool**
Segisti auk: **ilma aukudeta maisitajam**
Erimärkused: **2-tasandilise kausi tarvikud**

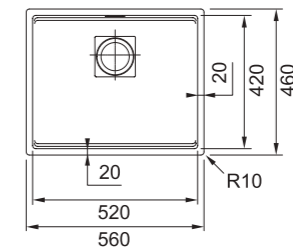

MYTHOS

1
2
3
4



Mudel: **KNG 110-37**
Aluskapp: **45 cm**
Mõõdud: **410 x 460 mm**
Väljalõige: **370 x 420 mm (R=10 mm)**
Kausi mõõtmed: **370 /420 /200 mm**
Paigaldamine: **altpoolt monteeritav**
Materjal: **Fragranit**
Ventil: **sealhulgas ventiil 3½" vajutusnupuga**
Ventili juhtimine: **Vajutusnupp ümmargune roostevaba teras**
Ventil kaas: **Katteplaadiga ülevool**
Ülevool: **katteplaadiga ülevool**
Segisti auk: **ilma aukudeta maisitajam**
Erimärkused: **2-tasandilise kausi tarvikud**

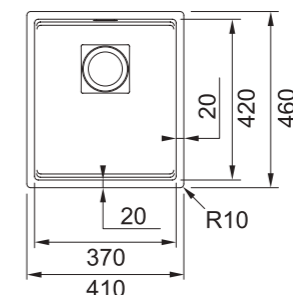

Onyx
125.0512.515
529.- €

Must matt
125.0627.321
543.- €

Polaarvalge
125.0512.506
434.- €

Kivihall
125.0512.507
434.- €

NEW
Slate Grey
125.0715.491
434.- €

Cashmere
125.0512.505
434.- €

Onyx
125.0512.504
434.- €

Must matt
125.0627.319
448.- €

Polaarvalge
125.0512.451
400.- €

Kivihall
125.0512.452
400.- €

NEW
Slate Grey
125.0715.492
400.- €

Cashmere
125.0512.450
400.- €

Onyx
125.0512.449
400.- €

Must matt
125.0627.320
414.- €

Maris



Lisad

- | | | | | |
|--|---|--|--|---|
| 1 | 2 | 3 | 4 | 5 |
| | | | | |
| 112.0030.882
Rullmatt painduv
468 x 420 mm
83.- € | 112.0188.651
Rv Mobiilne nõruti plastik
raamis 342 x 430 x 22 mm
114.- € | 112.0532.169
Roostevaba teras ventiili
kate 3 1/2"
10.- € | 112.0657.146
Must matt ventiili kate 3 1/2"
11.- € | ALL-IN
5 erinevat komplekti ALL IN
(rohkem lk 137) valamule:
340 x 540 mm
130.- ... 247.- € |

MARIS

- 1
- 2
- 3
- 4
- 5



Mudel: **MRG 110-72**
Aluskapp: **80 cm**
Mõõdud: **753 x 433 mm**
Väljalõige: **720 x 400 mm (R=20mm)**
Kausi mõõtmed: **720 /400 /200 mm**
Paigaldamine: **altpoolt monteeritav**
Materjal: **Fragranit**
Ventiil: **koos ventiiliga 3 1/2"**
Ventiili juhtimine: **vajutusnupp või pöördnupp või käsitsi sõela avamine/sulgemine**
Ventiil kaas: **ümarmargune**
Ülevool: **katteplaadiga ülevool**
Segisti auk: **ilma aukudeta**

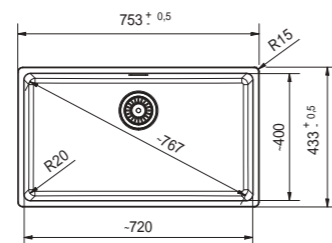

Manuaalventiil roostevabast terasest klapikaanega

- | | |
|------------|--|
| | Polaarvalge
125.0683.187
381.- € |
| | Kivihall
125.0683.186
381.- € |
| NEW | Slate Grey
125.0715.494
381.- € |
| | Cashmere
125.0683.188
381.- € |
| | Onyx
125.0683.185
381.- € |
| | Must matt
125.0683.189
381.- € |

Musta pöördnupuga ekstsentriline klapp ja musta ülevoolukaitsega must ventiil

- | | |
|--|--|
| | Must matt
125.0683.236
392.- € |
|--|--|

Käsitsi 3 1/2" ventiil musta klapi, ülevoolude ja klapikaanega

- | | |
|--|--|
| | Must matt
125.0683.235
381.- € |
|--|--|

MARIS

- 1
- 2
- 3
- 4
- 5



Mudel: **MRG 110-52**
Aluskapp: **60 cm**
Mõõdud: **553 x 433 mm**
Väljalõige: **520 x 400 mm (R=20mm)**
Kausi mõõtmed: **520 /400 /200 mm**
Paigaldamine: **altpoolt monteeritav**
Materjal: **Fragranit**
Ventiil: **koos ventiiliga 3 1/2"**
Ventiili juhtimine: **vajutusnupp või pöördnupp või käsitsi sõela avamine/sulgemine**
Ventiil kaas: **ümarmargune**
Ülevool: **katteplaadiga ülevool**
Segisti auk: **ilma aukudeta**

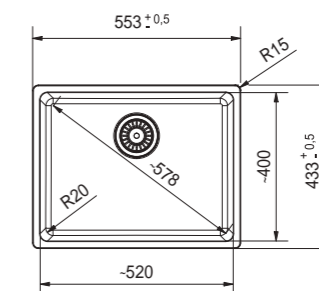

Ekstsentriline klapp ümmarguse terasest nupu ja roostevabast terasest klapikaanega

- | | |
|------------|--|
| | Polaarvalge
125.0683.103
439.- € |
| | Kivihall
125.0683.102
439.- € |
| NEW | Slate Grey
125.0715.495
439.- € |
| | Cashmere
125.0683.104
439.- € |
| | Onyx
125.0683.101
439.- € |
| | Must matt
125.0683.105
452.- € |

Manuaalventiil roostevabast terasest klapikaanega

- | | |
|------------|--|
| | Polaarvalge
125.0683.182
344.- € |
| | Kivihall
125.0683.181
344.- € |
| NEW | Slate Grey
125.0715.496
344.- € |
| | Cashmere
125.0683.183
344.- € |
| | Onyx
125.0683.140
344.- € |
| | Must matt
125.0683.184
358.- € |

Musta pöördnupuga ekstsentriline klapp ja musta ülevoolukaitsega must ventiil

- | | |
|--|--|
| | Must matt
125.0683.234
370.- € |
|--|--|

Käsitsi 3 1/2" ventiil musta klapi, ülevoolude ja klapikaanega

- | | |
|--|--|
| | Must matt
125.0683.233
358.- € |
|--|--|



Selles versioonis on klapp, klapiKate, ülevoolukate ja pöördnupp mattmattad. Juhtseadme tüüp võib olenevalt mudelist erineda.



Lisad

- | | | | | |
|--|--|---|---|---|
| <p>1 </p> <p>112.0030.882
Rollmatt painduv
468 x 420 mm
83.- €</p> | <p>2 </p> <p>112.0188.651
Rv Mobiilne nõruti plastik
raamis 342 x 430 x 22 mm
114.- €</p> | <p>3 </p> <p>112.0532.169
Roostevaba teras ventiili
kate 3½"
10.- €</p> | <p>4 </p> <p>112.0657.146
Must matt ventiili kate 3½"
11.- €</p> | <p>5 </p> <p>ALL-IN
5 erinevat komplekti ALL.IN
(rohkem lk 137) valamule:
340 x 540 mm
130.- ... 247.- €</p> |
|--|--|---|---|---|

MARIS

- 1
- 2
- 3
- 4
- 5



Mudel: **MRG 110-37**

Aluskapp: **45 cm**

Mõõdud: **403 x 433 mm**

Väljalõige: **370 x 400 mm (R=20mm)**

Kausi mõõtmed: **370 /400 /200 mm**

Paigaldamine: **altpoolt monteeritav**

Materjal: **Fragranit**

Ventiil: **koos ventiiliga 3½"**

Ventiili juhtimine: **vajutusnupp või pöördnupp või käsitsi**

sõela avamine/sulgumine



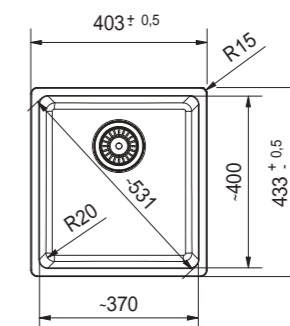

Ventiil kaas: **ümmargune**

Ülevool: **katteplaadiga ülevool**





Segisti auk: **ilma aukudeta**



Ekstsentriline klapp ümmarguse te-
rasest nupu ja roostevabast terasest
klapikaanega

- | | |
|---|--|
|  | Polaarvalge
125.0683.058
397.- € |
|  | Kivihall
125.0683.057
397.- € |
| NEW | Slate Grey
125.0715.497
397.- € |
|  | Cashmere
125.0683.059
397.- € |
|  | Onyx
125.0683.056
397.- € |
|  | Must matt
125.0683.060
397.- € |

Manuaalventiil roostevabast terasest
klapikaanega

- | | |
|---|--|
|  | Polaarvalge
125.0683.137
301.- € |
|  | Kivihall
125.0683.136
301.- € |
| NEW | Slate Grey
125.0715.498
301.- € |
|  | Cashmere
125.0683.138
301.- € |
|  | Onyx
125.0683.135
301.- € |
|  | Must matt
125.0683.139
314.- € |



Selles versioonis on klapp, klappikate,
ülevoolukate ja pöördnupp mattmus-
tad. Juhtseadme tüüp võib olenevalt
mudelist erineda.

Musta pöördnupuga ekstsentriline
klapp ja musta ülevoolukaitsega must
ventiil

- | | |
|---|--|
|  | Must matt
125.0683.232
323.- € |
|---|--|

Käsitsi 3½" ventiili musta klapi, üle-
voolude ja klapikaanega

- | | |
|---|--|
|  | Must matt
125.0683.231
314.- € |
|---|--|

Maris



Lisad



MARIS



Mudel: **MRG 110-72 A**
 Aluskapp: **80 cm**
 Mõõdud: **753 x 503 mm**
 Väljalõige: **vastavalt juhistele**
 Kausi mõõtmed: **720 /400 /200 mm**
 Paigaldamine: **altpoolt monteeritav**
 Materjal: **Fragranit**
 Ventiil: **koos ventiiliga 3½"**
 Ventiili juhtimine: **käsitsi avamine/ sulgemine**
 Ventiil kaas: **ümmargune**
 Ülevool: **katteplaadiga ülevool**
 Segisti auk: **ilma aukudeta (5 x 35 mm altpoolt puuritud augud)**

Musta pöördnupuga eksstsentriline klapp ja musta ülevoolukaitsega must ventiil

 **Must matt**
 125.0683.242
392.- €

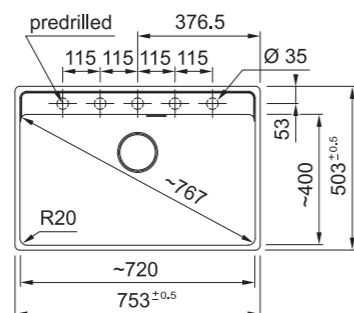

MARIS



Mudel: **MRG 110-52 A**
 Aluskapp: **60 cm**
 Mõõdud: **553 x 503 mm**
 Väljalõige: **vastavalt juhistele**
 Kausi mõõtmed: **520 /400 /200 mm**
 Paigaldamine: **altpoolt monteeritav**
 Materjal: **Fragranit**
 Ventiil: **koos ventiiliga 3½"**
 Ventiili juhtimine: **vajutusnupp või pöördnupp või käsitsi sõela avamine/sulgemine**
 Ventiil kaas: **ümmargune**
 Ülevool: **katteplaadiga ülevool**
 Segisti auk: **ilma aukudeta (3 x 35 mm altpoolt puuritud augud)**

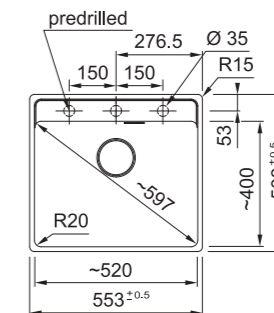

Manuaalventiil roostevabast terasest klappikaanega

 **Polaarvalge**
 125.0683.197
344.- €

 **Kivihall**
 125.0683.196
344.- €

 **Cashmere**
 125.0683.198
344.- €

 **Onyx**
 125.0683.195
344.- €

 **Must matt**
 125.0683.199
357.- €

Musta pöördnupuga eksstsentriline klapp ja musta ülevoolukaitsega must ventiil

 **Must matt**
 125.0683.240
370.- €

Käsitsi 3½" ventiil musta klapi, ülevoolude ja klappikaanega

 **Must matt**
 125.0683.239
357.- €

MARIS



Mudel: **MRG 110-37 A**
 Aluskapp: **45 cm**
 Mõõdud: **403 x 503 mm**
 Väljalõige: **vastavalt juhistele**
 Kausi mõõtmed: **370 /400 /200 mm**
 Paigaldamine: **altpoolt monteeritav**
 Materjal: **Fragranit**
 Ventiil: **koos ventiiliga 3½"**
 Ventiili juhtimine: **vajutusnupp või pöördnupp või käsitsi sõela avamine/sulgemine**
 Ventiil kaas: **ümmargune**
 Ülevool: **katteplaadiga ülevool**
 Segisti auk: **ilma aukudeta (3 x 35 mm altpoolt puuritud augud)**

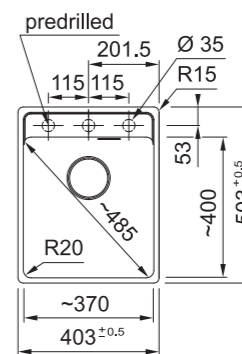



Manuaalventiil roostevabast terasest klappikaanega

 **Polaarvalge**
 125.0683.192
301.- €

 **Kivihall**
 125.0683.191
301.- €

 **Cashmere**
 125.0683.193
301.- €

 **Onyx**
 125.0683.190
301.- €

 **Must matt**
 125.0683.194
314.- €

Käsitsi 3½" ventiil musta klapi, ülevoolude ja klappikaanega

 **Must matt**
 125.0683.237
314.- €

Selles versioonis on klapp, klappikate, ülevoolukate ja pöördnupp mattmustad. Juhtseadme tüüp võib olenevalt mudelist erineda.





Tasapinnaline Maris seeria valamud

Maris



Lisad

1



112.0030.882
Rullmatt paindud
468 x 420 mm
83.- €

2



112.0188.651
Rv Mobiilne nõruti plastik
raamis 342 x 430 x 22 mm
114.- €

3



112.0532.169
Roostevaba teras ventiili
kate 3 1/2"
10.- €

4



112.0657.146
Must matt ventiili kate 3 1/2"
11.- €

5



ALL-IN
5 erinevat komplekti ALL IN
(rohkem lk 137) valamule:
340 x 540 mm
130.- ... 247.- €

MARIS

1
2
3
4
5

Mudel: **MRG 210-72**
Aluskapp: **80 cm**
Mõõdud: **753 x 433 mm**
Väljalõige: **vastavalt juhistele**
Kausi mõõtmed: **720 /400 /200 mm**
Paigaldamine: **tasapinnaline**
Materjal: **Fragranit**
Ventiil: **koos ventiiliga 3 1/2"**
Ventiili juhtimine: **käsitsi avamine/ sulgemine**
Ventiil kaas: **ümmargune**
Ülevool: **katteplaadiga ülevool**
Segisti auk: **ilma aukudeta**

Käsitsi 3 1/2" ventiil musta klapi, ülevoolu-
de ja klapikaanega



Must matt
135.0683.046
395.- €

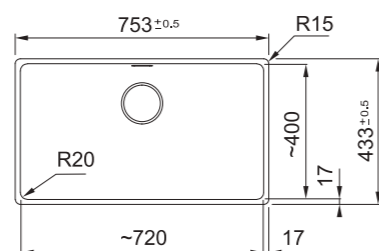

MARIS

1
2
3
4
5

Mudel: **MRG 210-72 A**
Aluskapp: **80 cm**
Mõõdud: **753 x 503 mm**
Väljalõige: **vastavalt juhistele**
Kausi mõõtmed: **720 /400 /200 mm**
Paigaldamine: **tasapinnaline**
Materjal: **Fragranit**
Ventiil: **koos ventiiliga 3 1/2"**
Ventiili juhtimine: **vajutusnupp või pöördnupp või käsitsi sõela avamine/sulgemine**
Ventiil kaas: **ümmargune**
Ülevool: **katteplaadiga ülevool**
Segisti auk: **ilma aukudeta (5 x 35 mm altpoolt puuritud augud)**

Manuaalventiil roostevabast terasest
klapikaanega



Polaarvalge
135.0683.025
381.- €

Kivihall
135.0683.024
381.- €

NEW

Slate Grey
135.0715.500
381.- €

Cashmere
135.0683.026
381.- €

Onyx
135.0683.023
381.- €

Must matt
135.0683.027
395.- €

Musta pöördnupuga eksentriline
klapp ja musta ülevoolukaitsega must
ventiil



Must matt
135.0683.055
405.- €

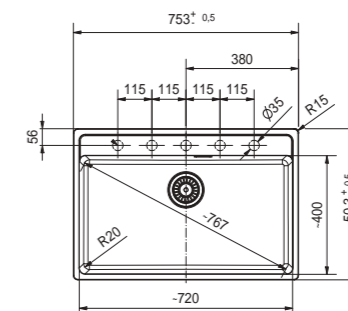

Maris



MARIS

1
2
3
4
5



Mudel: **MRG 210-52 A**
Aluskapp: **60 cm**
Mõõdud: **553 x 503 mm**
Väljalõige: **vastavalt juhistele**
Kausi mõõtmed: **520 /400 /200 mm**
Paigaldamine: **tasapinnaline**
Materjal: **Fragranit**
Ventiil: **koos ventiiliga 3½"**
Ventiili juhtimine: **vajutusnupp või pöördnupp või käsitsi sõela avamine/sulgemine**
Ventiil kaas: **ümmargune**
Ülevool: **katteplaadiga ülevool**
Segisti auk: **ilma aukudeta (3 x 35 mm altpoolt puuritud augud)**



Süvistatavaid valamuid saab paigaldada ainult niiskuskindlatele pindadele ja selleks on vaja vastavaid tööriistu. Enne süvistatava valamü ostmist palun veenduge, et köögitootja oskab sellist montaaži teha ja tööpind oleks ka sellele vastav.

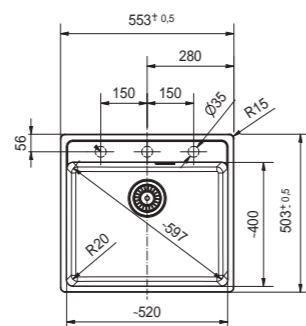

Manuaalventiil roostevabast terasest klapikaanega



NEW

Polaarvalge
135.0683.036
344.- €

Kivihall
135.0683.035
344.- €

Slate Grey
135.0715.508
344.- €

Cashmere
135.0683.037
344.- €

Onyx
135.0683.034
344.- €

Must matt
135.0683.038
357.- €

Musta pöördnupuga ekstsentriline klapp ja musta ülevoolukaitsega must ventiil



Must matt
135.0683.054
370.- €

Käsitsi 3½" ventiil musta klapi, ülevoolude ja klapikaanega



Must matt
135.0683.048
357.- €

MARIS

1
2
3
4
5



Mudel: **MRG 210-52**
Aluskapp: **60 cm**
Mõõdud: **553 x 433 mm**
Väljalõige: **vastavalt juhistele**
Kausi mõõtmed: **520 /400 /200 mm**
Paigaldamine: **tasapinnaline**
Materjal: **Fragranit**
Ventiil: **koos ventiiliga 3½"**
Ventiili juhtimine: **käsitsi avamine/sulgemine**
Ventiil kaas: **ümmargune**
Ülevool: **katteplaadiga ülevool**
Segisti auk: **ilma aukudeta**

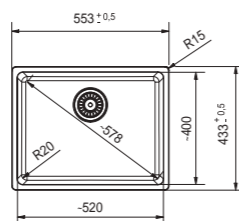

Käsitsi 3½" ventiil musta klapi, ülevoolude ja klapikaanega



Must matt
135.0683.051
370.- €

MARIS

1
2
3
4
5

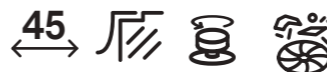

Mudel: **MRG 210-37 A**
Aluskapp: **45 cm**
Mõõdud: **403 x 503 mm**
Väljalõige: **vastavalt juhistele**
Kausi mõõtmed: **370 /400 /200 mm**
Paigaldamine: **tasapinnaline**
Materjal: **Fragranit**
Ventiil: **koos ventiiliga 3½"**
Ventiili juhtimine: **käsitsi avamine/sulgemine**
Ventiil kaas: **ümmargune**
Ülevool: **katteplaadiga ülevool**
Segisti auk: **ilma aukudeta (3 x 35 mm altpoolt puuritud augud)**

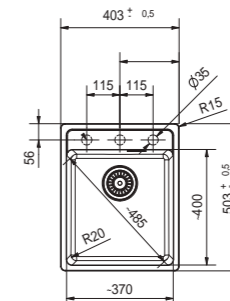

Musta pöördnupuga ekstsentriline klapp ja musta ülevoolukaitsega must ventiil



Must matt
135.0683.053
323.- €

MARIS

1
2
3
4
5



Mudel: **MRG 210-37**
Aluskapp: **45 cm**
Mõõdud: **403 x 433 mm**
Väljalõige: **vastavalt juhistele**
Kausi mõõtmed: **370 /400 /200 mm**
Paigaldamine: **tasapinnaline**
Materjal: **Fragranit**
Ventiil: **koos ventiiliga 3½"**
Ventiili juhtimine: **vajutusnupp või pöördnupp või käsitsi sõela avamine/sulgemine**
Ventiil kaas: **ümmargune**
Ülevool: **katteplaadiga ülevool**
Segisti auk: **ilma aukudeta**

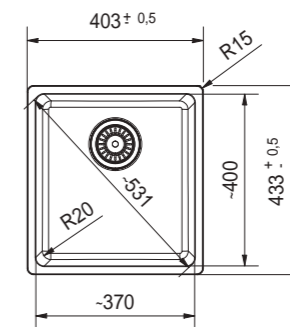

Manuaalventiil roostevabast terasest klapikaanega



Polaarvalge
135.0682.984
301.- €

Kivihall
135.0682.983
301.- €

NEW

Slate Grey
135.0715.504
301.- €

Cashmere
135.0682.985
301.- €

Onyx
135.0682.982
301.- €

Must matt
135.0682.986
314.- €



Selles versioonis on klapp, klapiKate, ülevoolukate ja pöördnupp mattmatted. Juhtseadme tüüp võib olenevalt mudelist erineda.

Musta pöördnupuga ekstsentriline klapp ja musta ülevoolukaitsega must ventiil



Must matt
135.0683.050
323.- €

Käsitsi 3½" ventiil musta klapi, ülevoolude ja klapikaanega



Must matt
135.0683.044
314.- €

Lisad

1



112.0030.882
Rullmatt painduv
468 x 420 mm
83.- €

2



112.0188.651
Rv Mobiilne nõruti plastik
raamis 342 x 430 x 22 mm
114.- €

3



112.0532.169
Roostevaba teras ventiili
kate 3½"
10.- €

4



112.0657.146
Must matt ventiili kate 3½"
11.- €

5



ALL-IN
5 erinevat komplekti ALL IN
(rohkem lk 137) valamule:
340 x 540 mm
130.-... 247.- €

Kubus



Lisad



112.0030.882
Rullmatt paindub
468 x 420 mm
83.- €

112.0188.651
Rv Mobiilne nõruti plastik
raamis 342 x 430 x 22 mm
114.- €

ALL-IN
5 erinevat komplekti ALL IN
(rohkem lk 137) valamule:
340 x 540 mm
130.- ... 247.- €

MYTHOS



1
2
3

Mudel: **KBK 160**
Aluskapp: **60 cm**
Mõõdud: **545 x 445 mm**
Väljalõige: **individuaalne**
Kausi mõõtmed: **375 / 385 / 185 + 115 / 385 / 115 mm**
Paigaldamine: **altpoolt monteeritav**
Kausi asukoht: **pööratav**
Materjal: **Fraceram**
Ventii: **Sealhulgas ventiiil 3½" vajutusnupuga**
Ventiiil juhtimine: **PushKnob Vajutusnupp ümmargune**
roostevaba teras (tööpinnale on vajalik auk 35mm)
Ventiiil väikese kausi jaoks: **Ventiiil 1½" mittersulguv**
Ülevool: **katteplaadiga ülevool**
Segisti auk: **ilma aukudeta**

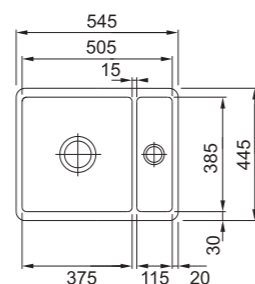

Tähelepanu mõõdud!
Keraamilise valamü mõõdud võivad
tehnoloogias tulenevalt erineda
joonistel toodud mõõtudest. Seepärast
soovitame väljalõige tööpinda teha
konkreetses valamü mõõtude järgi.
Samuti on keraamilisel valamul lubatud
minimaalne kõverus

MYTHOS



1
2
3

Mudel: **KBK 110-50**
Aluskapp: **60 cm**
Mõõdud: **545 x 445 mm**
Väljalõige: **individuaalne**
Kausi mõõtmed: **505 / 385 / 185 mm**
Paigaldamine: **altpoolt monteeritav**
Materjal: **Fraceram**
Ventii: **Sealhulgas ventiiil 3½" vajutusnupuga**
Ventiiil juhtimine: **PushKnob Vajutusnupp ümmargune**
roostevaba teras (tööpinnale on vajalik auk 35mm)
Ülevool: **katteplaadiga ülevool**
Segisti auk: **ilma aukudeta**

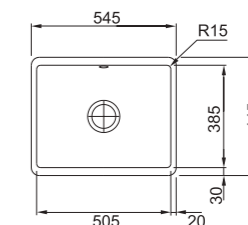

MYTHOS



1
2
3

Mudel: **KBK 110-40**
Aluskapp: **50 cm**
Mõõdud: **445 x 445 mm**
Väljalõige: **individuaalne**
Kausi mõõtmed: **405 / 385 / 185 mm**
Paigaldamine: **altpoolt monteeritav**
Materjal: **Fraceram**
Ventii: **Sealhulgas ventiiil 3½" vajutusnupuga**
Ventiiil juhtimine: **PushKnob Vajutusnupp ümmargune**
roostevaba teras (tööpinnale on vajalik auk 35mm)
Ülevool: **katteplaadiga ülevool**
Segisti auk: **ilma aukudeta**

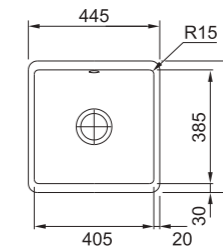

MYTHOS



1
2
3

Mudel: **KBK 110-70**
Aluskapp: **80 cm**
Mõõdud: **745 x 445 mm**
Väljalõige: **individuaalne**
Kausi mõõtmed: **705 / 385 / 175 mm**
Paigaldamine: **altpoolt monteeritav**
Materjal: **Fraceram**
Ventii: **Sealhulgas ventiiil 3½" vajutusnupuga**
Ventiiil juhtimine: **PushKnob Vajutusnupp ümmargune**
roostevaba teras (tööpinnale on vajalik auk 35mm)
Ülevool: **katteplaadiga ülevool**
Segisti auk: **ilma aukudeta**

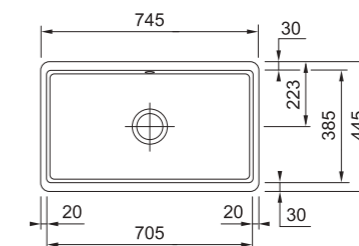

Tähelepanu mõõdud!
Keraamilise valamü mõõdud võivad
tehnoloogias tulenevalt erineda
joonistel toodud mõõtudest. Seepärast
soovitame väljalõige tööpinda teha
konkreetses valamü mõõtude järgi.
Samuti on keraamilisel valamul lubatud
minimaalne kõverus

Polaarvalge*
126.0335.712*
567.- €

Magnolia*
126.0335.880*
567.- €

Onyx
126.0335.883
567.- €

Antratsiit matt*
126.0380.350*
567.- €

* - Saadaval kuni sep-
tembrini 2025

Polaarvalge*
126.0335.711*
502.- €

Magnolia*
126.0335.875*
502.- €

Onyx
126.0335.878
502.- €

Antratsiit matt*
126.0380.352*
502.- €

* - Saadaval kuni sep-
tembrini 2025

Polaarvalge*
126.0381.439*
855.- €

Onyx*
126.0381.512*
855.- €

Antratsiit matt*
126.0381.518*
855.- €

* - Saadaval kuni sep-
tembrini 2025

ALL IN



Muudetava vahemaaga teleskoopraam sobib valamusse, mille diameeter on 340 kuni 540 mm.

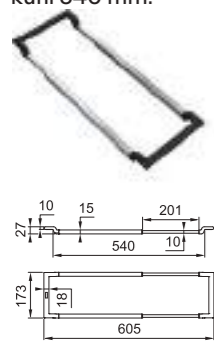

Bambusest lõikelaud.

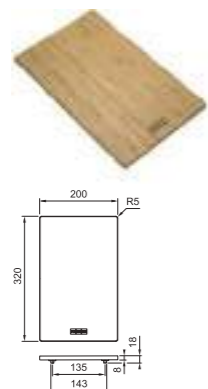

Suur pestav alus. Nõudepesumasinas pestav. Temperatuur < 100 °C.

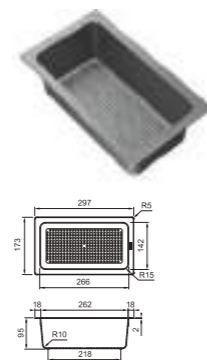

Väike loputusalus. Nõudepesumasinas pestav. Temperatuur < 100 °C.

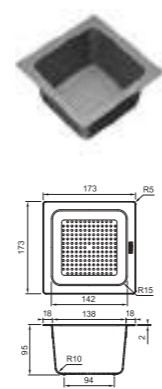

Toidu säilitusanum. Nõudepesumasinas pestav. Temperatuur < 100 °C.

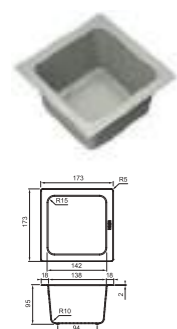

Säilitusanuma kaas on valmistatud bambusest.

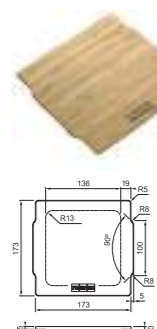

Laineline silikoonalus nõrgusa nõrutuspinnaga. Nõudepesumasinas pestav. Kuumi kuni temperatuuril 170 °C objekte võib sellele asetada ajutiselt.

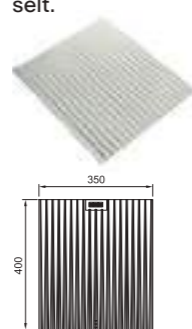

Säilituskarp kõigi All-In'i osade jaoks. Nõudepesumasinas pestav.

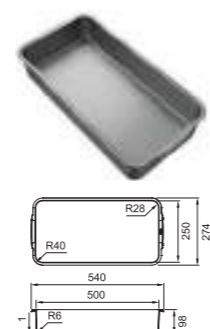

Komplekt Nr. 1

112.0655.481

- Teleskoopraam
- Lõikelaud
- Suur loputusalus

130.- €



Komplekt Nr. 2

112.0655.482

- Teleskoopraam
- Lõikelaud
- Väike loputusalus
- Väike kogumisanum
- Anuma kaas

141.- €



Komplekt Nr. 3

112.0655.483

- Teleskoopraam
- Lõikelaud
- Suur loputusalus
- Kokkupandav matt

193.- €



Komplekt Nr. 4

112.0655.488

- Teleskoopraam
- Lõikelaud
- Väike loputusalus
- Väike kogumisanum
- Anuma kaas
- Kokkupandav matt

207.- €

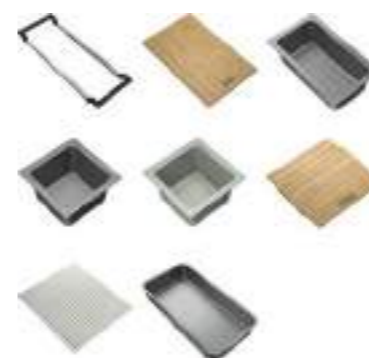

Komplekt Nr. 5

112.0655.489

- Teleskoopraam
- Lõikelaud
- Suur loputusalus
- Väike loputusalus
- Väike kogumisanum
- Anuma kaas
- Kokkupandav matt
- Säilituskarp

247.- €



Segistid



- 140 Ülevaade
- 143 Vital
- 145 Atlas Clear Water
- 146 Roostevabast terasest segistid
- 147 Mythos Masterpiece
- 153 Atlas Neo Sensor
- 160 Kroomitud ja värvilised segistid
- 178 Seebidosaatorid



Segistid

Filtreeritud vee segistid filtriga ja ilma



Vital
143. lk.



Atlas Clear Water
145. lk.

Roostevabast terasest



Mythos M
147. lk.

Pescara XL
149. lk.

Pescara L
149. lk.



Mythos
148. lk.

Taros Neo
151. lk.



Atlas Neo Sensor
153. lk.

Atlas Neo
154. lk.

Atlas Neo
155. lk.

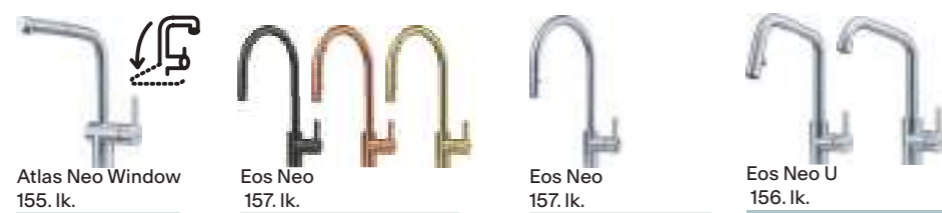

Atlas Neo Window
155. lk.

Eos Neo
157. lk.

Eos Neo
157. lk.

Eos Neo U
156. lk.



Smart Glenda
159. lk.

Orbit
158. lk.

Kroomitud ja värvilised segistid

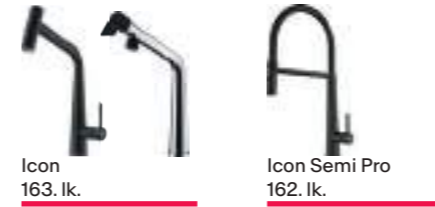

Icon
163. lk.

Icon Semi Pro
162. lk.



Pescara 360
160. lk.

Pescara J
161. lk.



Active L
167. lk.

Urban
169. lk.

Centro
168. lk.



Active Semi-Pro
164. lk.

Active J
165. lk.

Fox Pro
161. lk.



Lina XL
172. lk.

Lina
173. lk.

Lina U
174. lk.

Lina L
175. lk.

Sirius L
177. lk.

Orbit
170. lk.



Lina Semi Pro
172. lk.

Old England
176. lk.

Novara Plus
171. lk.

Basis
176. lk.

Seebidosaa-
torid



Atlas
178. lk.



Active Plus
178. lk.



Novita Steel
179. lk.



Comfort
179. lk.



Novita
179. lk.



MYTHOS



1

2



VITAL

Segisti mudel: **Kombineeritud filtreeritud ja kuuma/ külma vee jaoks**

Vee väljavool: **väljatõmmatava dušiga/ normaalse vooluga (lülitiga)**

Aeraatori tüüp: **laminaarne vool**

Pöördenurk: **360°**

Materjal: **roostevaba teras**

Segisti kang: **kang paremal**

Filtreeritud vee kang: **Kang üleval**

Veevool: **7,6 l/min (3 bar)**

Filtreeritud vee vool: **3,5 l/min (3 bar)**

Ühendustorud: **420 mm**

Filtreeritava vee maht: **500L**

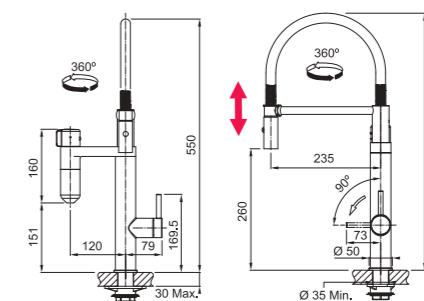

Kroom /Gunmetal
120.0621.230
877.- €

tööstuslik must /roostevaba teras
120.0621.313
960.- €

MYTHOS



1

2



VITAL

Segisti mudel: **Kombineeritud filtreeritud ja kuuma/ külma vee jaoks**

Vee väljavool: **fikseeritud otsikuga pööratava tilaga**

Aeraatori tüüp: **laminaarne vool**

Pöördenurk: **360°**

Materjal: **roostevaba teras**

Segisti kang: **kang paremal**

Filtreeritud vee kang: **Kang üleval**

Veevool: **12,5 l/min (3 bar)**

Filtreeritud vee vool: **3,5 l/min (3 bar)**

Ühendustorud: **420 mm**

Filtreeritava vee maht: **500L**

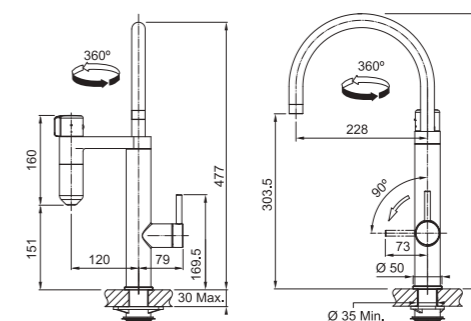

Kroom /Gunmetal
120.0621.229
628.- €

tööstuslik must /roostevaba teras
120.0621.312
711.- €

Lisad

1



112.0607.497
Vital segisti filter
500L
43.- €

2



112.0607.498
Vital segisti filtrikomplekt
(komplektis 3 filtrikapslit)
500L x3
118.- €



Clear Water



Clear Water



MARIS



360°

1

2



Atlas Clear Water

Segisti mudel: **Kombineeritud filtreeritud ja kuuma/ külma vee jaoks (kaasas on filter)**

Vee väljavool: **fikseeritud otsikuga pööratava tilaga**

Pöördenurk: **360°**

Materjal: **roostevaba teras**

Segisti kang: **külgedel mõlemal küljel**

Veevool: **10 l/min (3 bar)**

Filtri jõudlus sõltub vee karedusest ja puhtusest

Lisatarvikud, mis kuuluvad komplekti:

- Segisti (120.0179.978)
- + filtri komplekt 133.0284.025
- ühendused veefiltri krüvimiseks
- ühendusmehhanism
- Franke Pro M filtrikassett 8000L
- Claris taimer

Minimaalne kaugus segisti keskelt seinani 70 mm

Roostevaba teras

160.0705.404

574.- €

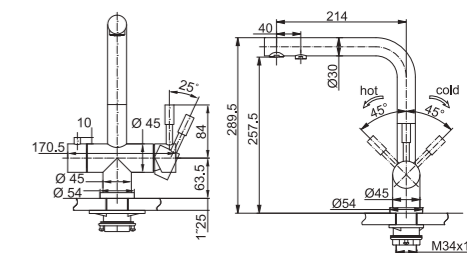

MARIS



360°

1

2



Eos Clear Water

Segisti mudel: **Kombineeritud filtreeritud ja kuuma/ külma vee jaoks (kaasas on filter)**

Vee väljavool: **fikseeritud otsikuga pööratava tilaga**

Pöördenurk: **360°**

Materjal: **roostevaba teras**

Segisti kang: **külgedel mõlemal küljel**

Veevool: **10 l/min (3 bar)**

Filtri jõudlus sõltub vee karedusest ja puhtusest

Lisatarvikud, mis kuuluvad komplekti:

- Segisti (120.0179.979)
- + filtri komplekt 133.0284.025
- ühendused veefiltri krüvimiseks
- ühendusmehhanism
- Franke Pro M filtrikassett 8000L
- Claris taimer

Minimaalne kaugus segisti keskelt seinani 70 mm

Roostevaba teras

160.0705.403

574.- €

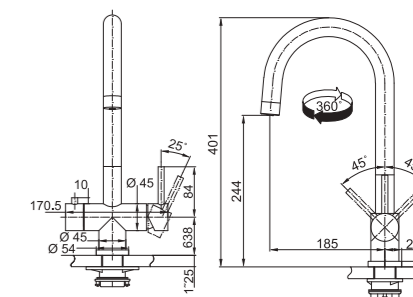

Lisad

1



133.0284.026
Franke Pro M filtrikassett
8000L
97.- €

2

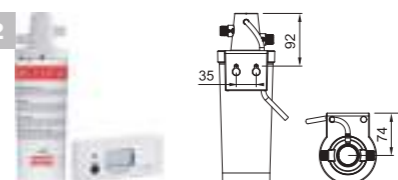

133.0284.025
Franke Pro M filtrikassett 8000L, ühendusmehhanism ja Clarise taimer (komplekt)
187.- €

Mythos Masterpiece

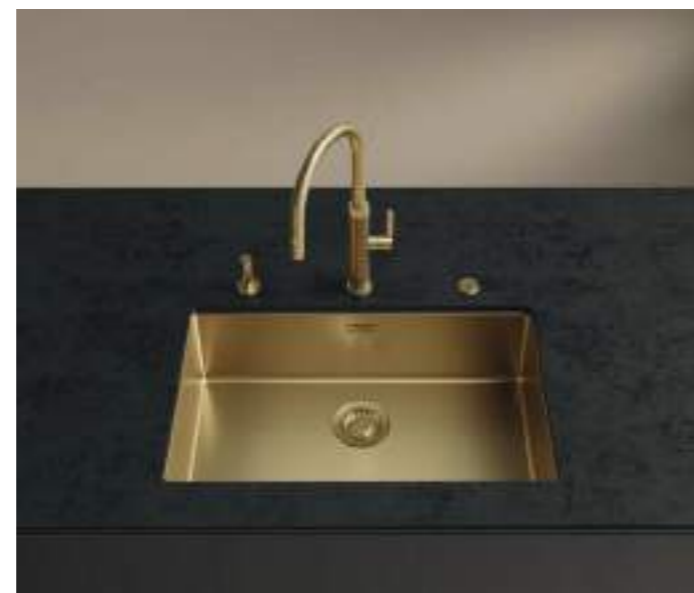

Mythos Masterpiece

MYTHOS

NEW



Mythos Masterpiece

Segisti mudel: **köögisegisti**

Vee väljavool: **väljatõmmatava dušiga/ normaalse vooluga (lülitiga)**

Aeraatori tüüp: **laminaarne vool**

Pöördenurk: **360°**

Materjal: **roostevaba teras**

Segisti kang: **kang paremal**

Ühendustorud: **550 mm**

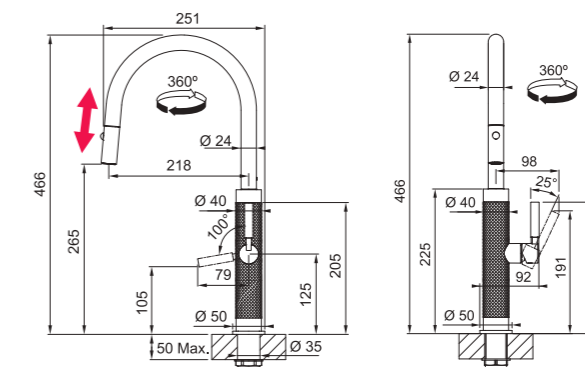

Roostevaba teras
115.0711.554
449.- €

Antratsiit
115.0711.555
559.- €

Vask
115.0711.557
559559.- €

Šampanjakuldne
115.0711.558
554.- €



Roostevaba teras



Antratsiit



Vask



Šampanjakuldne



MYTHOS



Taros Neo

Segisti mudel: **köögisegisti**
 Vee väljavool: **väljatõmmatava otsikuga**
 Aeraatori tüüp: **laminaarne vool**
 Pöördnurk: **120°**
 Materjal: **roostevaba teras**
 Segisti kang: **Kang üleval**
 Veevool: **8 l/min (3 bar)**
 Ühendustorud: **420 mm**

Roostevaba teras
 115.0596.383
321.- €

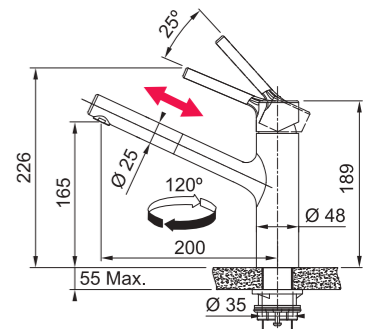

MYTHOS



Taros Neo

Segisti mudel: **köögisegisti**
 Vee väljavool: **fikseeritud otsikuga pööratava tilaga**
 Aeraatori tüüp: **laminaarne vool**
 Pöördnurk: **120°**
 Materjal: **roostevaba teras**
 Segisti kang: **Kang üleval**
 Veevool: **12 l/min (3 bar)**
 Ühendustorud: **420 mm**

Roostevaba teras
 115.0596.320
267.- €

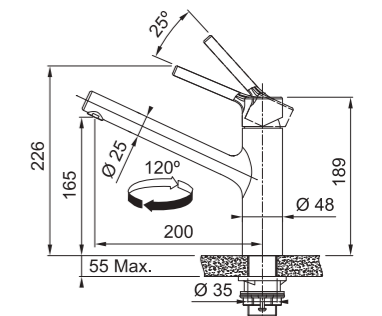

Atlas Neo Sensor



Roostevabast terasest veesegistid ATLAS NEO SENSOR anduri ja tavapärase juhtimisega

Mudelid on saadaval nii väljatõmmatava kui ka fikseeritud otsikuga. Roostevaba teras on kergesti hooldatav ja hügieeniliselt ohutu. Võib valida kriimustuskindla tööstuslikult musta kattega segisti.

M24 laminaarne aeraator vähendab pritsmeid ja muudab vee voolamise ühtlaseks.

Andurite abil juhtimine parandab köögihügieeni, kuna saame vett sageli kasutada ilma segistit füüsiliselt puudutamata.



ANDURI JUHTIMINE

Liigutades oma käe 6 cm või lähemale vasakule küljele asuva anduri juurde ja vesi hakkab voolama 1 sekundi pärast. 30 sekundi pärast vool peatub. Vee temperatuur määratakse juhtnupu nupuga. Selle toiteallikaks on neli AA patareid, mis muudab süsteemi sõltumatuks. See säästab vett, kuna lülitame veevarustuse välja sageli hiljem kui vaja.

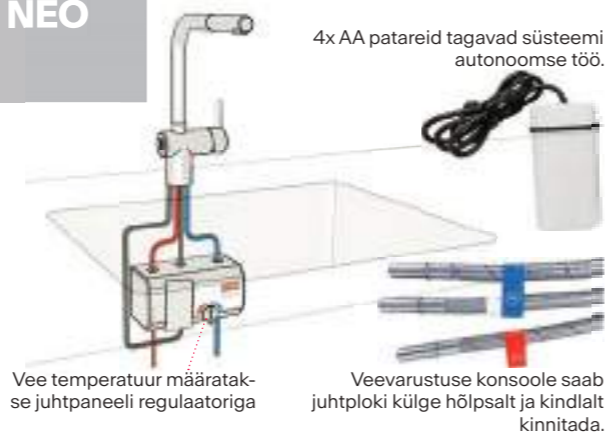

Vee temperatuur määratakse juhtpaneeli regulaatoriga

Veevarustuse konsoole saab juhtploki külge hõlpsalt ja kindlalt kinnitada.

KANGIGA JUHTIMINE

Paremal küljel on kang, mille abil saab veevarustust tavapärasel viisil reguleerida. Keraamiline tööosa tagab pikaks ajaks ohutu töötamise.



ATLAS NEO SENSOR
Segisti mudel: **Sensori ja käsitsi juhtimisega köögisegisti**
Vee väljavool: **väljatõmmatava otsikuga**
Aeraatori tüüp: **laminaarne vool**
Pöördenurk: **180°**
Materjal: **roostevaba teras**
Segisti kang: **kang paremal**
Veevool: **7 l/min (3 bar)**
Sensor Veevool: **4 l/min (3 bar)**
Ühendustorud: **450 mm**

Komplektis: **Juhtimiseseade koos 4 AA1,5 V patareiga (komplektis)**
Anduri töö: **Anduriga sisselülitamisel seiskub veevool automaatselt 30 sekundi pärast**

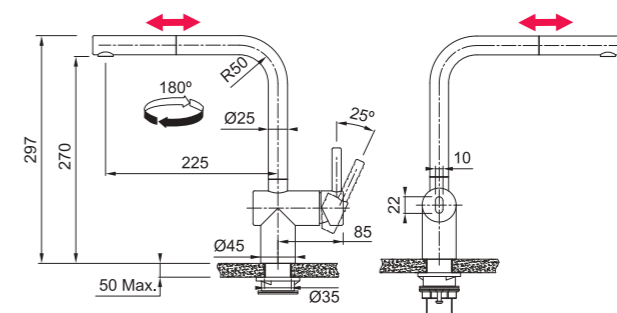

Roostevaba teras
115.0625.523
565.- €

Tööstuslik must
115.0625.527
604.- €

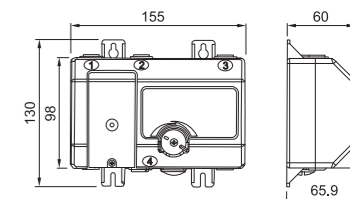

ATLAS NEO SENSOR
Segisti mudel: **Sensori ja käsitsi juhtimisega köögisegisti**
Vee väljavool: **fikseeritud otsikuga pööratava tilaga**
Aeraatori tüüp: **laminaarne vool**
Pöördenurk: **180°**
Materjal: **roostevaba teras**
Segisti kang: **kang paremal**
Veevool: **7,5 l/min (3 bar)**
Sensor Veevool: **4 l/min (3 bar)**
Ühendustorud: **450 mm**

Komplektis: **Juhtimiseseade koos 4 AA1,5 V patareiga (komplektis)**
Anduri töö: **Anduriga sisselülitamisel seiskub veevool automaatselt 30 sekundi pärast**

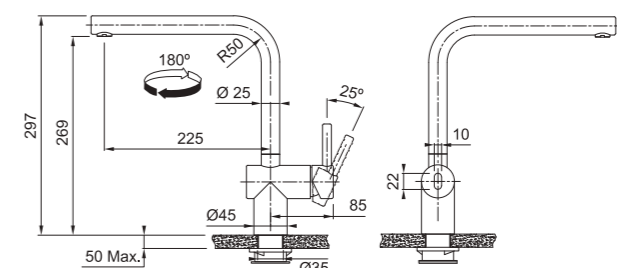

Roostevaba teras
115.0625.489
469.- €

Tööstuslik must
115.0625.525
503.- €

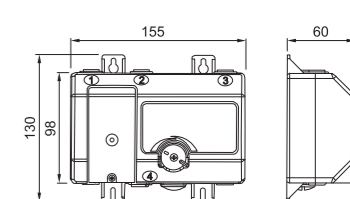

Kuulühendus. Veetoru ei saa tänu kuulühendusele pöörelda ning toimib liikuva üleminekuna veetoru ja väljatõmmatava otsaku vahel. Väljalaskevooliku vahetamine on nüüd veelgi lihtsam.

Paigaldusjuhised



Atlas Neo



Atlas Neo



MARIS



Atlas Neo
 Segisti mudel: **köögisegisti**
 Vee väljavool: **väljatõmmatava otsikuga**
 Aeraatori tüüp: **laminaarne vool**
 Pöördenurk: **180°**
 Materjal: **roostevaba teras**
 Segisti kang: **kang paremal**
 Veevool: **9,7 l/min (3 bar)**
 Ühendustorud: **450 mm**

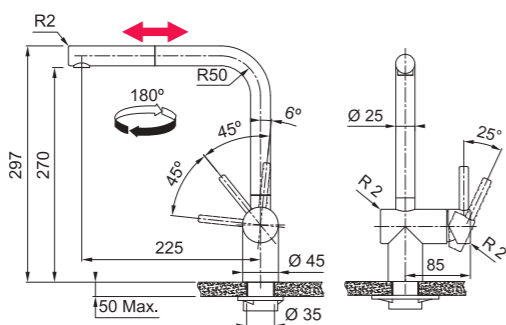

Kuulühendus. Veetoru ei saa tänu kuulühendusele pöörelda ning toimib liikuva üleminekuna veetoru ja väljatõmmatava otsaku vahel. Väljalaskevooliku vahetamine on nüüd veelgi lihtsam.

- Roostevaba teras**
115.0521.438
308.- €
- Tööstuslik must**
115.0550.427
360.- €
- Antratsiit**
115.0628.210
360.- €
- Vask**
115.0628.208
360.- €
- Šampanjakuldne**
115.0681.242
360.- €

MARIS



Atlas Neo Window
 Segisti mudel: **Köögikatted on akna poolt kokkuklapitavad**
 Vee väljavool: **väljatõmmatava otsikuga**
 Aeraatori tüüp: **laminaarne vool**
 Pöördenurk: **180°**
 Materjal: **roostevaba teras**
 Segisti kang: **kang paremal**
 Veevool: **8,2 l/min (3 bar)**
 Ühendustorud: **600 mm**

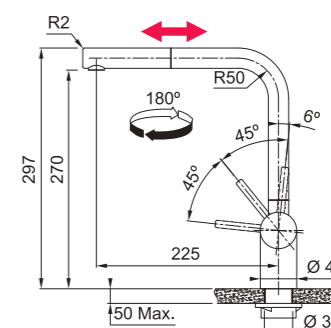

- Roostevaba teras**
115.0521.439
334.- €



MARIS



Atlas Neo
 Segisti mudel: **köögisegisti**
 Vee väljavool: **fikseeritud otsikuga pööratava tilaga**
 Aeraatori tüüp: **laminaarne vool**
 Pöördenurk: **180°**
 Materjal: **roostevaba teras**
 Segisti kang: **kang paremal**
 Veevool: **12,2 l/min (3 bar)**
 Ühendustorud: **450 mm**

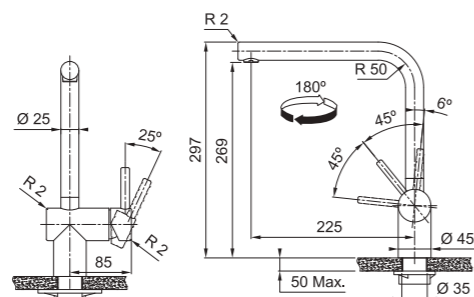

- Roostevaba teras**
115.0521.435
257.- €
- Tööstuslik must**
115.0550.424
308.- €
- Antratsiit**
115.0628.207
308.- €
- Vask**
115.0628.204
308.- €
- Šampanjakuldne**
115.0681.241
308.- €

MARIS



Atlas Neo
 Segisti mudel: **köögisegisti**
 Vee väljavool: **väljatõmmatava dušiga/ normaalse vooluga (lülitiga)**
 Aeraatori tüüp: **laminaarne vool**
 Pöördenurk: **180°**
 Materjal: **roostevaba teras**
 Segisti kang: **kang paremal**
 Veevool: **8,6 l/min (3 bar)**
 Ühendustorud: **450 mm**

Silikoondušši katlakivi vastane toime

- Roostevaba teras**
115.0521.441
327.- €

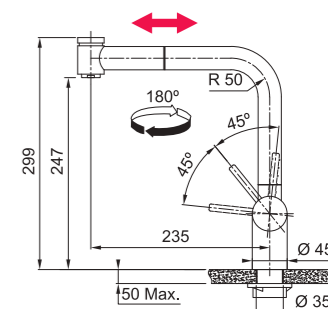



MARIS



Eos Neo U
 Segisti mudel: **köögisegisti**
 Vee väljavool: **väljatõmmatava otsikuga**
 Aeraatori tüüp: **laminaarne vool**
 Pöördenurk: **180°**
 Materjal: **roostevaba teras**
 Segisti kang: **kang paremal**
 Veevool: **8,5 l/min (3 bar)**
 Ühendustorud: **450 mm**

Roostevaba teras
 115.0529.207
325.- €

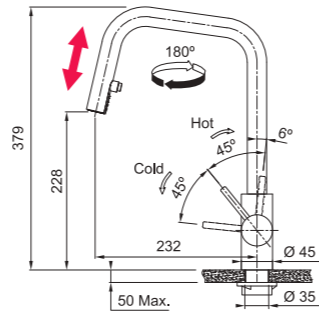

MARIS



Eos Neo U
 Segisti mudel: **köögisegisti**
 Vee väljavool: **fikseeritud otsikuga pööratava tilaga**
 Aeraatori tüüp: **laminaarne vool**
 Pöördenurk: **180°**
 Materjal: **roostevaba teras**
 Segisti kang: **kang paremal**
 Veevool: **12,7 l/min (3 bar)**
 Ühendustorud: **450 mm**

Roostevaba teras
 115.0529.202
268.- €

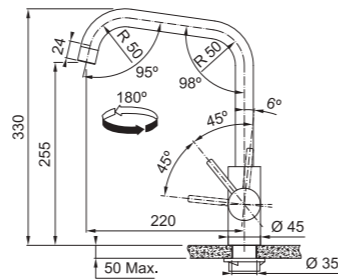

Valige sobiv vedelseebi
 dosaator 178. lk.



MARIS



EOS-NEO
 Segisti mudel: **köögisegisti**
 Vee väljavool: **väljatõmmatava dušiga/ normaalse vooluga (lülitiga)**
 Aeraatori tüüp: **laminaarne vool**
 Pöördenurk: **180°**
 Materjal: **roostevaba teras**
 Segisti kang: **kang paremal**
 Veevool: **10 l/min (3 bar)**
 Ühendustorud: **450 mm**

Roostevaba teras
 115.0590.045
325.- €

Tööstuslik must
 115.0613.671
456.- €

Antratsiit
 115.0628.256
385.- €

Vask
 115.0628.254
385.- €

Šampanjakuldne
 115.0681.244
385.- €

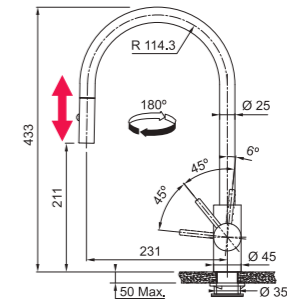

MARIS



EOS-NEO
 Segisti mudel: **köögisegisti**
 Vee väljavool: **fikseeritud otsikuga pööratava tilaga**
 Aeraatori tüüp: **laminaarne vool**
 Pöördenurk: **180°**
 Materjal: **roostevaba teras**
 Segisti kang: **kang paremal**
 Veevool: **12 l/min (3 bar)**
 Ühendustorud: **450 mm**

Roostevaba teras
 115.0590.044
268.- €

Tööstuslik must
 115.0613.590
344.- €

Antratsiit
 115.0628.253
318.- €

Vask
 115.0628.251
318.- €

Šampanjakuldne
 115.0681.243
318.- €

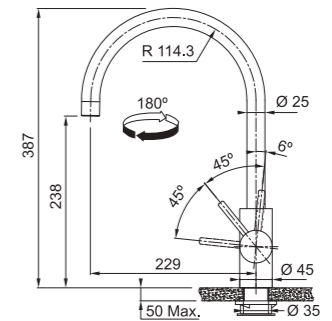

Orbit



SMART



120°

Orbit
Segisti mudel: **köögisegisti**
Vee väljavool: **väljatõmmatava otsikuga**
Aeraatori tüüp: **laminaarne vool**
Pöördenurk: **120°**
Materjal: **roostevaba teras**
Segisti kang: **Kang üleval**
Veevool: **8,5 l/min (3 bar)**
Ühendustorud: **450 mm**

Roostevaba teras
115.0569.461
168.- €

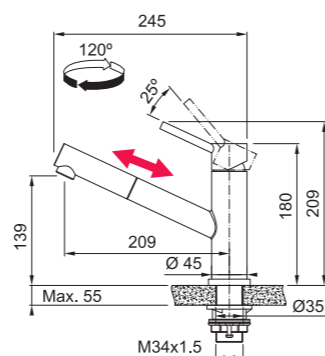

SMART



360°

Orbit
Segisti mudel: **köögisegisti**
Vee väljavool: **fikseeritud otsikuga pööratava tilaga**
Aeraatori tüüp: **laminaarne vool**
Pöördenurk: **360°**
Materjal: **roostevaba teras**
Segisti kang: **Kang üleval**
Veevool: **13 l/min (3 bar)**
Ühendustorud: **450 mm**

Roostevaba teras
115.0569.290
142.- €

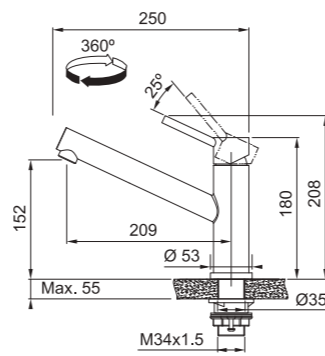

Valige sobiv vedelseebi dosaator 178. lk.

Smart Glenda



SMART



180°

SMART GLENDA
Segisti mudel: **köögisegisti**
Vee väljavool: **väljatõmmatava otsikuga**
Aeraatori tüüp: **laminaarne vool**
Pöördenurk: **180°**
Materjal: **roostevaba teras**
Segisti kang: **kang paremal**
Veevool: **9 l/min (3 bar)**
Ühendustorud: **500 mm**

Roostevaba teras
115.0706.986
199.- €

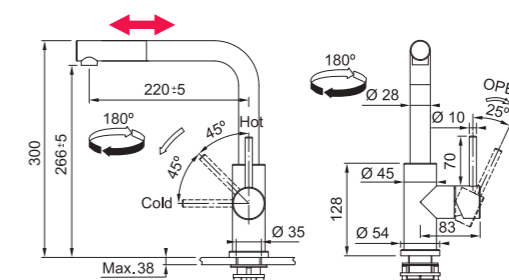

SMART



180°

SMART GLENDA
Segisti mudel: **köögisegisti**
Vee väljavool: **fikseeritud otsikuga pööratava tilaga**
Aeraatori tüüp: **laminaarne vool**
Pöördenurk: **180°**
Materjal: **roostevaba teras**
Segisti kang: **kang paremal**
Veevool: **12,3 l/min (3 bar)**

Roostevaba teras
115.0706.985
165.- €

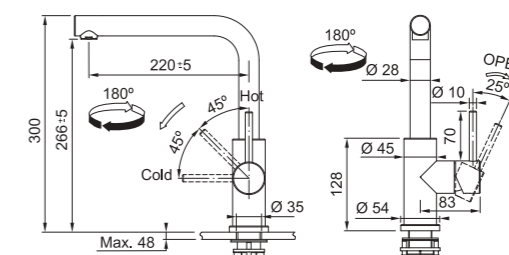

Pescara



MYTHOS



Pescara 360°

Segisti mudel: **köögisegisti**
 Vee väljavool: **väljatõmmatava dušiga/ normaalse**
vooluga (lülitiga)
 Pöördenurk: **360°**
 Segisti kang: **kang paremal**
 Veevool: **9 l/min (3 bar)**
 Ühendustorud: **450 mm**

Kroom
 115.0393.976
569.- €

Must matt
 115.0545.136
628.- €

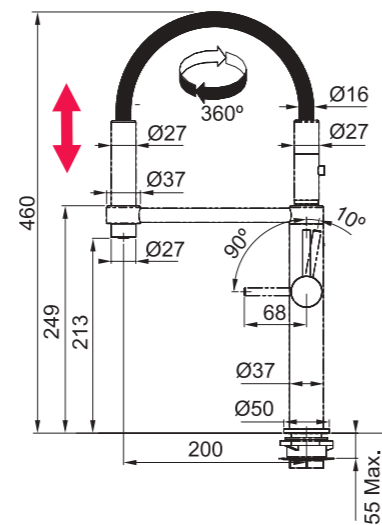

Pescara J Fox Pro



MYTHOS

NEW



Pescara J

Segisti mudel: **köögisegisti**
 Vee väljavool: **väljatõmmatava dušiga/ normaalse**
vooluga (lülitiga)
 Aeraatori tüüp: **laminaarne vool**
 Pöördenurk: **180°**
 Segisti kang: **kang paremal**
 Ühendustorud: **450 mm**

Must matt
 115.0575.968
474.- €

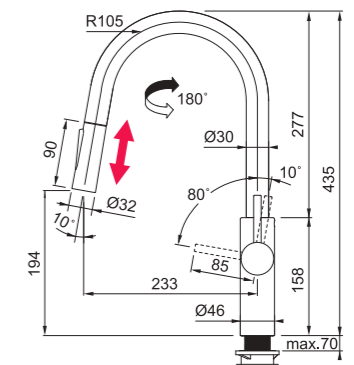

MARIS



Fox Pro

Segisti mudel: **köögisegisti**
 Vee väljavool: **väljatõmmatava dušiga/ normaalse**
vooluga (lülitiga)
 Pöördenurk: **360°**
 Segisti kang: **kang paremal**
 Veevool: **10 l/min (3 bar)**
 Ühendustorud: **450 mm**

Kroom*
 115.0486.993*
258.- €

* - Mudel saadaval kuni märtsini 2026

Minimaalne kaugus segisti keskelt seinani 35 mm

Soovitame selle paigaldada töötasapinnale või graniidist valamule. RV valamule paigaldamisel tuleks kasutada segisti stabilisaatorit 133.0026.896

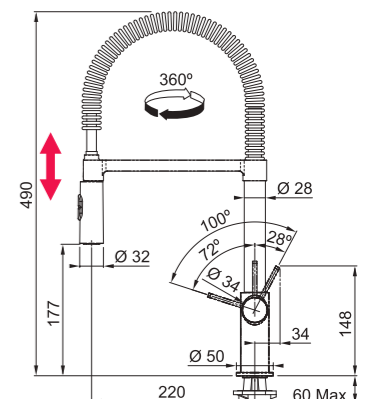



MYTHOS



Icon
 Segisti mudel: **köögisegisti**
 Vee väljavool: **väljatõmmatava dušiga/ normaalse vooluga (lülitiga)**
 Aeraatori tüüp: **laminaarne vool**
 Pöördenurk: **360°**
 Segisti kang: **kang paremal**
 Veevool: **7,5 l/min (3 bar)**
 Ühendustorud: **450 mm**

Kroom
 115.0625.188
457.- €

Must matt
 115.0625.190
577.- €

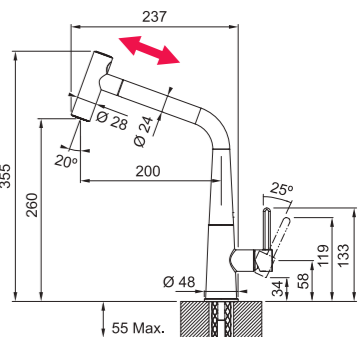

MYTHOS



Icon Semi Pro
 Segisti mudel: **köögisegisti**
 Vee väljavool: **väljatõmmatava dušiga/ normaalse vooluga (lülitiga)**
 Aeraatori tüüp: **laminaarne vool**
 Pöördenurk: **360°**
 Segisti kang: **kang paremal**
 Veevool: **7,7 l/min (3 bar)**

Must matt
 115.0690.598
651.- €

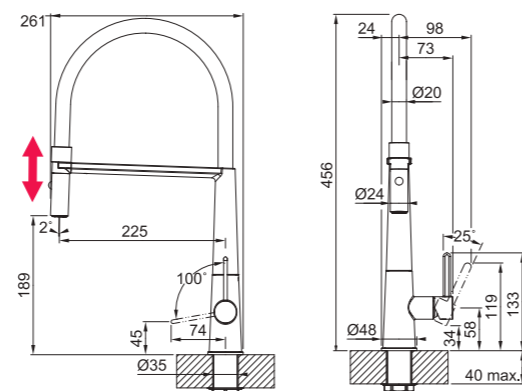

MYTHOS

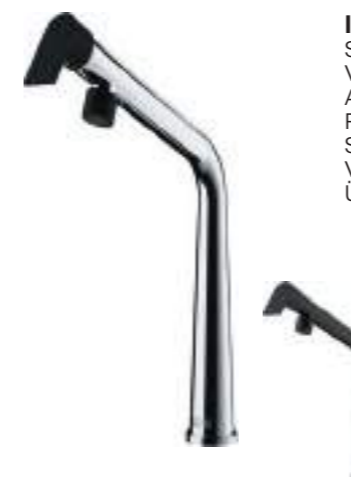

Icon
 Segisti mudel: **köögisegisti**
 Vee väljavool: **fikseeritud otsikuga pööratava tilaga**
 Aeraatori tüüp: **laminaarne vool**
 Pöördenurk: **120°**
 Segisti kang: **Kang üleval**
 Veevool: **11,4 l/min (3 bar)**
 Ühendustorud: **450 mm**

Kroom
 115.0625.185
349.- €

Must matt
 115.0625.187
471.- €

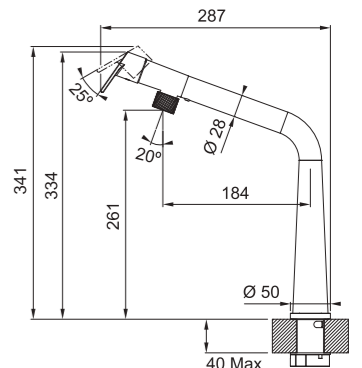

Valige sobiv vedelseebi dosaator 178. lk.

Active Semi-Pro



MARIS



Active Semi-Pro
 Segisti mudel: köögisegisti
 Vee väljavool: väljatõmmatava dušiga/ normaalse vooluga (lülitiga)
 Aeraatori tüüp: laminaarne vool
 Pöördenurk: 180°
 Segisti kang: kang paremal
 Veevool: 7,5 l/min (3 bar)
 Ühendustorud: 450 mm

Kroom
 115.0653.407
 477.- €

Must matt
 115.0653.409
 506.- €

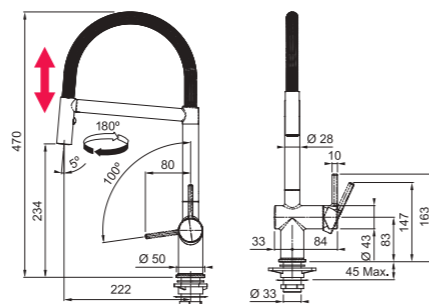

Active J



MARIS



Active J
 Segisti mudel: köögisegisti
 Vee väljavool: väljatõmmatava dušiga/ normaalse vooluga (lülitiga)
 Aeraatori tüüp: laminaarne vool
 Pöördenurk: 180°
 Segisti kang: kang paremal
 Veevool: 7,5 l/min (3 bar)
 Ühendustorud: 450 mm
 Silikoondušši katlakivi vastane toime

Kroom
 115.0653.401
 332.- €

Must matt
 115.0653.404
 371.- €

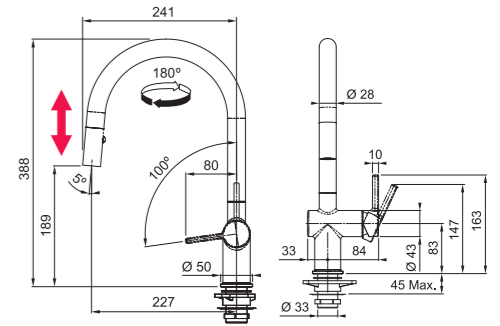

MARIS



ACTIVE J
 Segisti mudel: köögisegisti
 Vee väljavool: fikseeritud otsikuga pööratava tilaga
 Aeraatori tüüp: laminaarne vool
 Pöördenurk: 180°
 Segisti kang: kang paremal
 Veevool: 8,3 l/min (3 bar)
 Ühendustorud: 450 mm

Kroom
 115.0653.395
 266.- €

Must matt
 115.0653.398
 290.- €

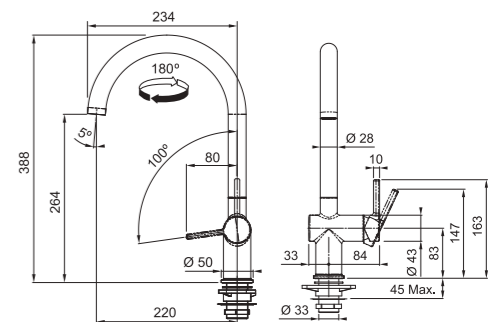









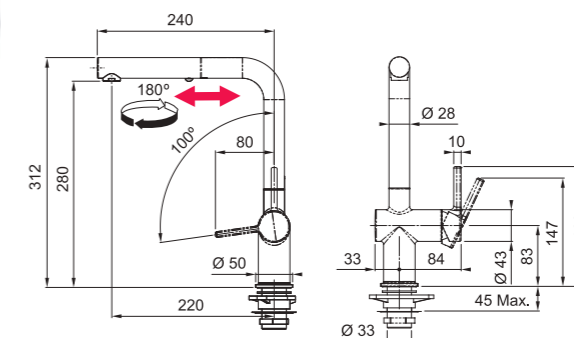

MARIS



Active L

Segisti mudel: **köögisegisti**
 Vee väljavool: **väljatõmmatava otsikuga**
 Aeraatori tüüp: **laminaarne vool**
 Pöördnurk: **180°**
 Segisti kang: **kang paremal**
 Veevool: **7,5 l/min (3 bar)**
 Ühendustorud: **450 mm**



-  **Kroom**
115.0653.379
325.- €
-  **Valge matt ***
115.0653.383 *
338.- €
-  **Must matt**
115.0653.382
346.- €
-  **Polaarvalge**
115.0653.387
338.- €
-  **Kivihall**
115.0653.385
338.- €
-  **Slate Grey**
115.0721.464
338.- €
-  **Cashmere**
115.0653.389
338.- €
-  **Onyx**
115.0653.384
338.- €

* - Mudel saadaval kuni aprillini 2025







MARIS

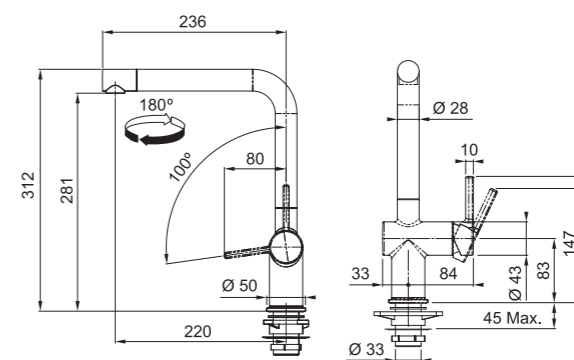

Active L

Segisti mudel: **köögisegisti**
 Vee väljavool: **fikseeritud otsikuga pööratava tilaga**
 Aeraatori tüüp: **laminaarne vool**
 Pöördnurk: **360°**
 Segisti kang: **kang paremal**
 Veevool: **8,3 l/min (3 bar)**
 Ühendustorud: **450 mm**



-  **Kroom**
115.0653.298
258.- €
-  **Must matt**
115.0653.371
282.- €
-  **Polaarvalge**
115.0653.376
272.- €
-  **Kivihall**
115.0653.374
272.- €
-  **Slate Grey**
115.0721.463
272.- €
-  **Cashmere**
115.0653.378
272.- €
-  **Onyx**
115.0653.373
272.- €

* - Mudel saadaval kuni aprillini 2025



Valige sobiv vedelseebi
 dosaator 178. lk.



Centro
Segisti mudel: **köögisegisti**
Vee väljavool: **väljatõmmatava otsikuga**
Aeraatori tüüp: **laminaarne vool**
Pöördnurk: **120°**
Segisti kang: **Kang üleval**
Veevool: **9 l/min (3 bar)**
Ühendustorud: **420 mm**

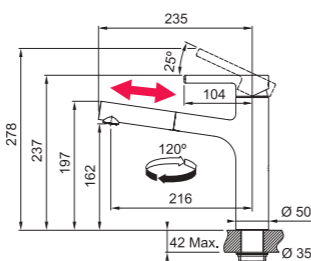

Kroom
115.0600.098
242.- €

Must matt
115.0621.592
290.- €



Urban
Segisti mudel: **köögisegisti**
Vee väljavool: **väljatõmmatava otsikuga**
Pöördnurk: **150°**
Segisti kang: **kang paremal**
Veevool: **9 l/min (3 bar)**
Ühendustorud: **450 mm**

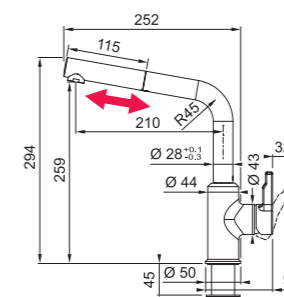

Kroom
115.0595.083
223.- €

Polaarvalge
115.0595.088
246.- €

Kivihall
115.0595.089
246.- €

Cashmere
115.0595.093
246.- €

Onyx
115.0595.091
246.- €

Must matt
115.0627.523
258.- €

NEW



Centro
Segisti mudel: **köögisegisti**
Vee väljavool: **fikseeritud otsikuga pööratava tilaga**
Aeraatori tüüp: **laminaarne vool**
Pöördnurk: **150°**
Segisti kang: **Kang üleval**
Veevool: **12 l/min (3 bar)**
Ühendustorud: **420 mm**

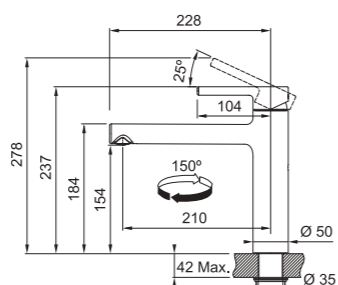

Kroom
115.0600.095
205.- €

Must matt
115.0621.613
246.- €



Urban
Segisti mudel: **köögisegisti**
Vee väljavool: **fikseeritud otsikuga pööratava tilaga**
Aeraatori tüüp: **laminaarne vool**
Pöördnurk: **360°**
Segisti kang: **kang paremal**
Veevool: **12 l/min (3 bar)**
Ühendustorud: **450 mm**

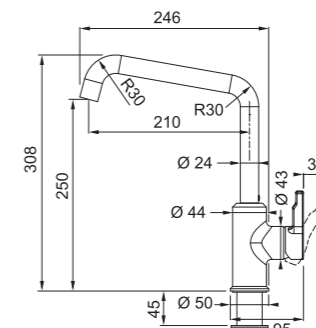

Kroom
115.0595.062
186.- €

Polaarvalge
115.0595.068
209.- €

Kivihall
115.0595.069
209.- €

Cashmere
115.0595.066
209.- €

Onyx
115.0595.081
209.- €

Must matt
115.0627.524
221.- €

NEW

Valige sobiv vedelseebi
dosaator 178. lk.

Orbit



Orbit
Segisti mudel: **köögisegisti**
Vee väljavool: **väljatõmmatava otsikuga**
Aeraatori tüüp: **laminaarne vool**
Pöördnurk: **120°**
Segisti kang: **Kang üleval**
Veevool: **9,9 l/min (3 bar)**
Ühendustorud: **450 mm**

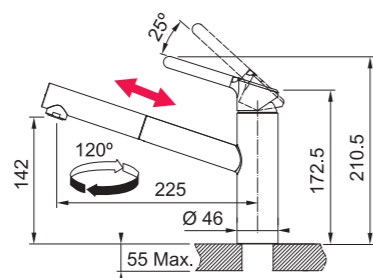

- Kroom**
115.0623.055
143.- €
- Kroom/ Polaarvalge**
115.0623.139
168.- €
- Kroom/ Kivihall**
115.0623.141
168.- €
- Kroom/ Cashmere**
115.0623.147
168.- €
- Kroom/ Onyx**
115.0623.057
168.- €
- Kroom/ Must matt**
115.0659.965
182.- €



Orbit
Segisti mudel: **köögisegisti**
Vee väljavool: **fikseeritud otsikuga pööratava tilaga**
Aeraatori tüüp: **laminaarne vool**
Pöördnurk: **360°**
Segisti kang: **Kang üleval**
Veevool: **11,9 l/min (3 bar)**
Ühendustorud: **450 mm**

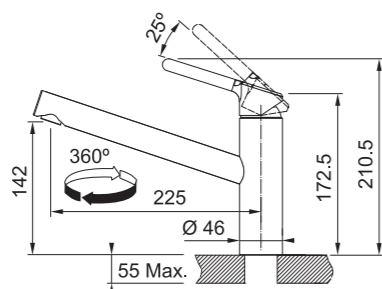

- Kroom**
115.0623.054
121.- €
- Kroom/ Polaarvalge**
115.0623.137
142.- €
- Kroom/ Kivihall**
115.0623.140
142.- €
- Beež ***
115.0623.135 *
142.- €
- Kroom/ Cashmere**
115.0623.146
142.- €
- Kroom/ Onyx**
115.0623.056
142.- €
- Kroom/ Must matt**
115.0659.964
157.- €

Valige sobiv vedelseebi dosaator 178. lk.

* - Mudel saadaval kuni juunini 2025

Novara-Plus



Novara-Plus
Segisti mudel: **köögisegisti**
Vee väljavool: **väljatõmmatava dušiga/ normaalse vooluga (lülitiga)**
Pöördnurk: **120°**
Segisti kang: **Kang üleval**
Veevool: **10,3 l/min (3 bar)**
Duširežiimid voolavad: **8,1 l/min (3 bar)**
Ühendustorud: **450 mm**



- Kroom**
115.0347.111
110.- €
- Polaarvalge**
115.0470.669
136.- €
- Kivihall**
115.0470.670
136.- €
- Beež**
115.0470.665
136.- €
- Cashmere**
115.0470.666
136.- €
- Onyx**
115.0470.675
136.- €
- Must matt**
115.0659.840
148.- €



Novara-Plus
Segisti mudel: **köögisegisti**
Vee väljavool: **fikseeritud otsikuga pööratava tilaga**
Pöördnurk: **360°**
Segisti kang: **Kang üleval**
Veevool: **16,3 l/min (3 bar)**
Ühendustorud: **450 mm**

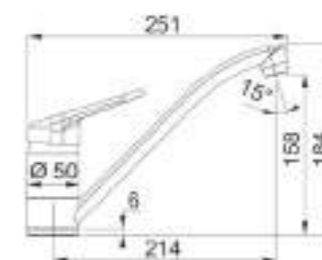

- Kroom**
115.0347.142
73.- €
- Polaarvalge**
115.0470.658
100.- €
- Kivihall**
115.0470.659
100.- €
- Beež**
115.0470.654
100.- €
- Cashmere**
115.0470.655
100.- €
- Onyx**
115.0470.661
100.- €



SMART



Lina Semi Pro
 Segisti mudel: **köögisegisti**
 Vee väljavool: **väljatõmmatava dušiga/ normaalse vooluga (lülitiga)**
 Pöördenurk: **150°**
 Segisti kang: **kang paremal**
 Veevool: **9 l/min (3 bar)**
 Ühendustorud: **450 mm**

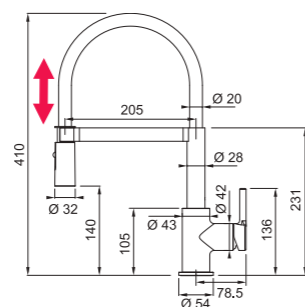

Kroom/ melns
 115.0626.085
151.- €



SMART



Lina Semi Pro
 Segisti mudel: **köögisegisti**
 Vee väljavool: **väljatõmmatava dušiga/ normaalse vooluga (lülitiga)**
 Pöördenurk: **150°**
 Segisti kang: **kang paremal**
 Veevool: **9 l/min (3 bar)**
 Ühendustorud: **450 mm**

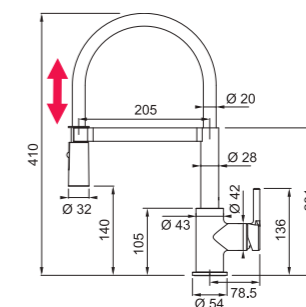

Must matt *
 115.0725.838 *
163.- €

* - Mudel saadaval alates märtsist 2025

SMART



Lina XL
 Segisti mudel: **köögisegisti**
 Vee väljavool: **fikseeritud otsikuga pööratava tilaga**
 Pöördenurk: **360°**
 Segisti kang: **kang paremal**
 Veevool: **14 l/min (3 bar)**
 Ühendustorud: **450 mm**

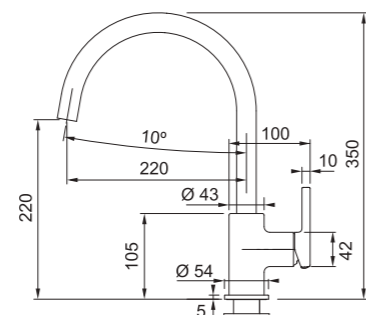

Kroom
 115.0693.228
105.- €

Polaarvalge
 115.0626.024
117.- €

Kivihall
 115.0626.022
117.- €

Beež
 115.0626.026
117.- €

Cashmere
 115.0626.028
117.- €

Onyx
 115.0626.020
117.- €

Must matt
 115.0626.019
128.- €

SMART



Lina
 Segisti mudel: **köögisegisti**
 Vee väljavool: **väljatõmmatava otsikuga**
 Pöördenurk: **150°**
 Segisti kang: **kang paremal**
 Veevool: **9,3 l/min (3 bar)**
 Ühendustorud: **420 mm**

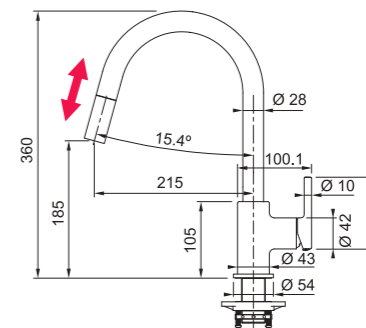

Kroom
 115.0693.229
119.- €

Polaarvalge
 115.0626.081
128.- €

Kivihall
 115.0626.057
128.- €

Beež
 115.0626.083
128.- €

Cashmere
 115.0626.084
128.- €



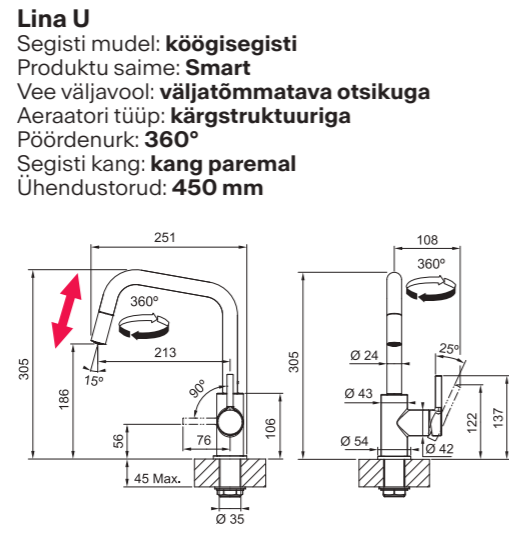

Onyx
 115.0626.055
128.- €

Must matt
 115.0626.053
140.- €

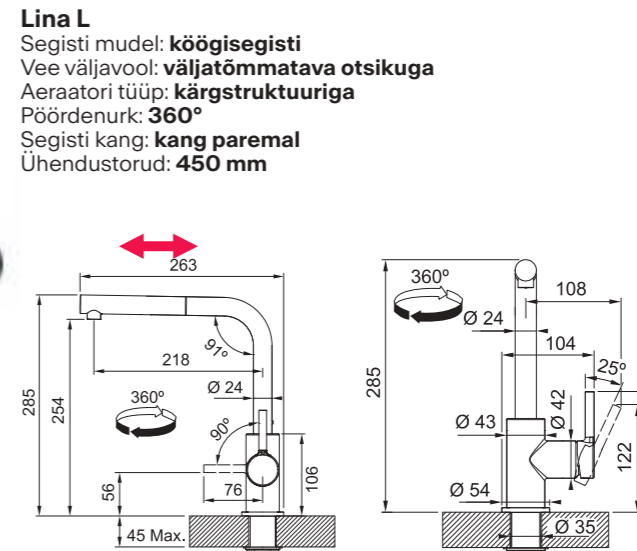

-  **Kroom***
115.0728.476*
176.- €
 -  **Must matt***
115.0728.477*
200.- €
- * - Mudel saadaval alates märtsist 2025





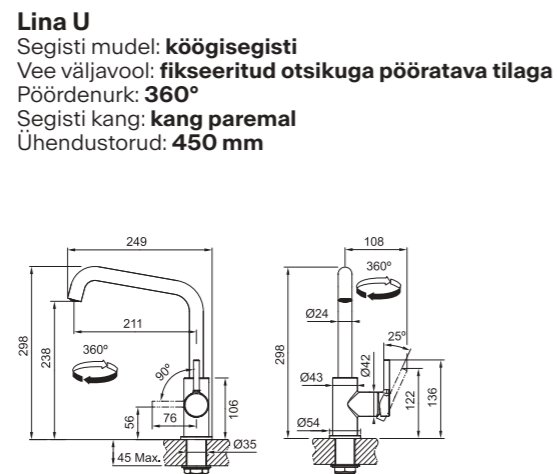

-  **Kroom**
115.0712.420
139.- €
 -  **Polaarvalge ***
115.0728.485 *
146.- €
 -  **Kivihall ***
115.0728.486 *
146.- €
 -  **Onyx ***
115.0728.484 *
146.- €
 -  **Must matt**
115.0712.435
152.- €
- * - Mudel saadaval alates märtsist 2025

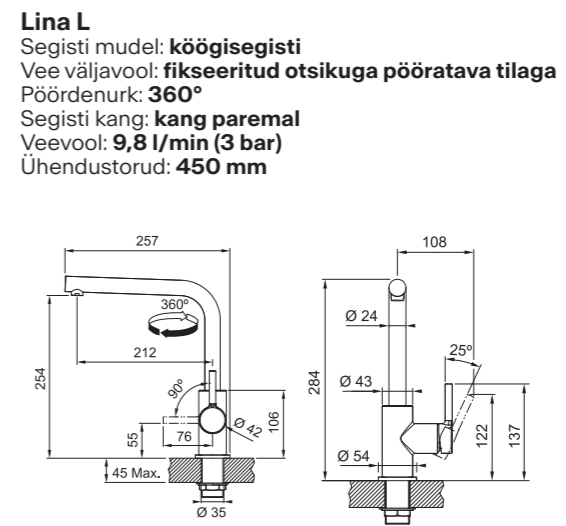

-  **Kroom ***
115.0728.473*
137.- €
 -  **Must matt ***
115.0728.474*
161.- €
- * - Mudel saadaval alates märtsist 2025



-  **Kroom**
115.0693.230
127.- €
 -  **Polaarvalge ***
115.0728.479 *
135.- €
 -  **Kivihall ***
115.0728.480 *
135.- €
 -  **Onyx ***
115.0728.478 *
135.- €
 -  **Must matt**
115.0693.393
141.- €
- * - Mudel saadaval alates märtsist 2025

Old England, Basic



SMART





Old England

Segisti mudel: **köögisegisti**
 Vee väljavool: **fikseeritud otsikuga pööratava tilaga**
 Pöördnurk: **360°**
 Segisti kang: **kang paremal**
 Veevool: **12 l/min (3 bar)**
 Ühendustorud: **450 mm**
 Aluse läbimõõt: **56 mm**

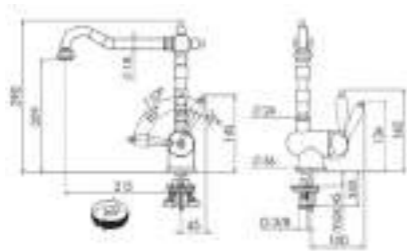
Minimaalne kaugus segisti keskelt seinani 45 mm



-  **Kroom**
115.0060.360
189.- €
-  **Pronks**
115.0028.205
199.- €
-  **Vask**
115.0028.208
199.- €

SMART



Basic

Segisti mudel: **köögisegisti**
 Vee väljavool: **fikseeritud otsikuga pööratava tilaga**
 Pöördnurk: **360°**
 Segisti kang: **kang üleval**
 Ühendustorud: **450 mm**

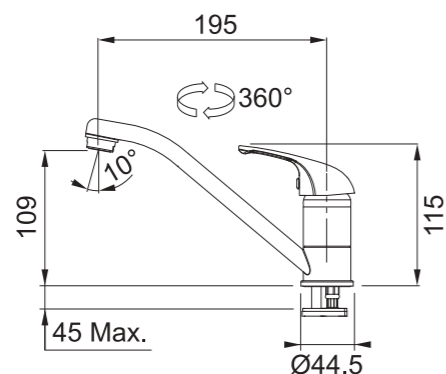

NEW

-  **Kroom**
115.0707.619
67.- €

Sirius









SMART

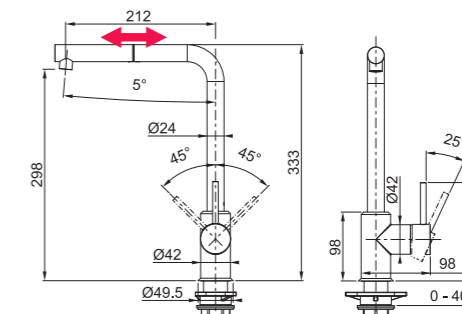

Sirius L

Segisti mudel: **köögisegisti**
 Vee väljavool: **väljatõmmatava otsikuga**
 Pöördnurk: **360°**
 Segisti kang: **külgedel mõlemal küljel**
 Veevool: **9,6 l/min (3 bar)**
 Ühendustorud: **400 mm**
 Minimaalne kaugus segisti keskelt seinani 80 mm



-  **Kroom**
115.0668.280
121.- €
-  **Polaarvalge ***
115.0668.382 *
130.- €
-  **Kivihall ***
115.0668.381 *
130.- €
-  **Beež ***
115.0668.383 *
130.- €
-  **Onyx**
115.0668.279
130.- €

* - Mudel saadaval kuni aprillini 2025

Seebidosaatorid



MYTHOS



ATLAS
Tüüp: Seebidosaator
Paigaldamine: Valamule või tööpinnale
Täitke ülalt
Maht: 350 ml
Tööpinna paigaldusaugud: 25 või 35 mm

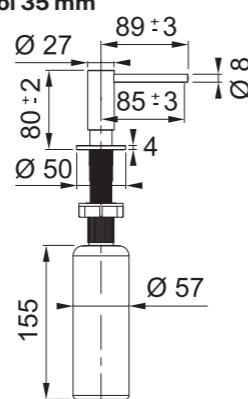

- Roostevaba teras
112.0717.084
62.- €
- Tööstuslik must
112.0717.102
81.- €
- Antratsiit
112.0717.103
81.- €
- Vask
112.0717.104
81.- €
- Šampanjakuldne
112.0717.105
81.- €



ACTIVE PLUS
Tüüp: Seebidosaator
Paigaldamine: Valamule või tööpinnale
Täitke ülalt
Maht: 300 ml
Tööpinna paigaldusaugud: 25 või 35 mm

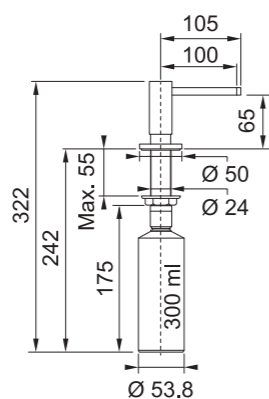

NEW

- Kroom
119.0547.902
103.- €
- Valge matt
119.0547.905
115.- €
- Slate Grey
112.0726.571
115.- €
- Must matt
119.0547.906
115.- €



NOVITA STEEL
Tüüp: Seebidosaator
Paigaldamine: Valamule või tööpinnale
Täitke ülalt
Maht: 250 ml
Tööpinna paigaldusaugud: 19, 25 või 35 mm

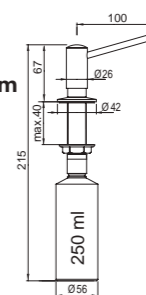

- Roostevaba teras
119.0177.893
207.- €



COMFORT
Tüüp: Seebidosaator
Paigaldamine: Valamule või tööpinnale
Täitke ülalt
Maht: 250 ml
Tööpinna paigaldusaugud: 25 või 35 mm

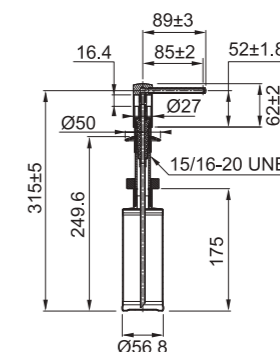

- Kroom
119.0584.065
49.- €
- Roostevaba värv
119.0578.771
49.- €
- Polaarvalge / Kroom
119.0578.748
49.- €
- Kivihall / Kroom
119.0578.744
49.- €
- Beež / Kroom
119.0578.745
49.- €
- Cashmere / Kroom
119.0578.750
49.- €
- Onyx / Kroom
119.0578.743
49.- €



Novita
Tüüp: Seebidosaator
Paigaldamine: Valamule või tööpinnale
Täitke ülalt
Maht: 300 ml
Tööpinna paigaldusaugud: 19, 25 või 35 mm

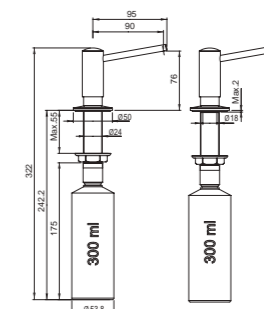

- Kroom
119.0150.262
86.- €
- Roostevaba värv
119.0155.993
108.- €



Sorterid



- 182 FX
(60 cm aluskapp)
- 183 Garbo 60, EasySort 60
(60 cm aluskapp)
- 184 Garbo 50-3, Cube 50
(50 cm aluskapp)
- 185 Garbo 45-2, EasySort 45
(45 cm aluskapp)
- 186 Pivot, Mini, Cube 40
(40 cm aluskapp)
- 187 Cube 30
(30 cm aluskapp)
- 187 Lisad
- 188 ELITE SLIM
Jäätmepurustajad



60 cm



MYTHOS



FX

Aluskapp: **60 cm**
Mõõdud: **600 x 506 x 448 mm**
Sorteri tüüp: **esiuksega avatav**
Paigaldamine: **kinnitatakse külgseinte külge lihtne paigaldada, šabloon kaasas**

Erimärkused:

- sisseehitatud aktiivsöefilter
- plastikust sahtel mahutite kaanena
- plastist raam prügikottide kinnitamiseks
- ukse reguleerimine küljelt

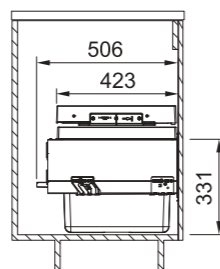
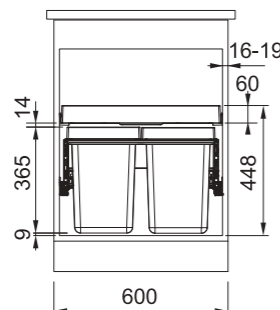

Maht 2x 26L
121.0557.764
251.- €

Maht 26L + 2x 11L
121.0557.763
251.- €

MARIS

1
3
5
7



Garbo 60-4

Aluskapp: **60 cm**
Mõõdud: **562 x 399 x 360 mm**
Sorteri tüüp: **esiuksega avatav**
Paigaldamine: **kinnitatakse külgseinte külge**

Erimärkused:

- metallist riul mahutite kaanena
- ukse reguleerimine küljelt
- sujuv sulgumine
- täielikult väljatulev, kandejõud 45 kg

Maht 2x 12L + 2x 8L
121.0200.676
178.- €

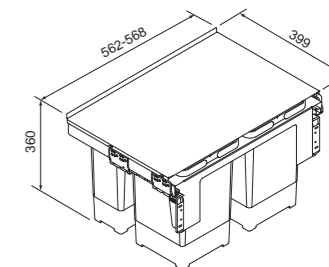

MARIS

1 7
2 8
4 9
5 10
6 11



Garbo 60-3

Aluskapp: **60 cm**
Mõõdud: **562 x 399 x 360 mm**
Sorteri tüüp: **esiuksega avatav**
Paigaldamine: **kinnitatakse külgseinte külge**

Erimärkused:

- metallist riul mahutite kaanena
- ukse reguleerimine küljelt
- sujuv sulgumine
- täielikult väljatulev, kandejõud 45 kg
- mahuti kasutatud patareidele

Maht 18L + 12L + 8L
121.0200.680
178.- €

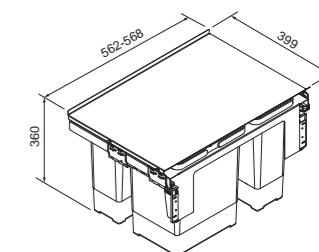

MARIS

4
9
10



Garbo 60-2

Aluskapp: **60 cm**
Mõõdud: **562 x 399 x 360 mm**
Sorteri tüüp: **esiuksega avatav**
Paigaldamine: **kinnitatakse külgseinte külge**

Erimärkused:

- metallist riul mahutite kaanena
- ukse reguleerimine küljelt
- sujuv sulgumine
- täielikult väljatulev, kandejõud 45 kg

Maht 2x 18L
121.0284.027
178.- €

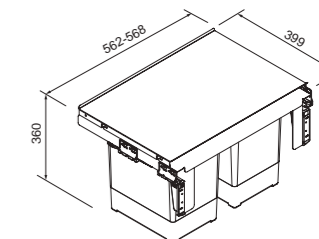

SMART

4
9
10



EASY SORT 60

Aluskapp: **60 cm**
Mõõdud: **564 x 378 x 343 mm**
Sorteri tüüp: **sahtlisse paigaldatav**
Paigaldamine: **kasutab köögikapi sahtlit**

Erimärkused:

- toodetud taaskasutatud plastist
- eriti tugev käepide (kuni 18 kg)
- antiseptiline materjal takistab 99% bakterite paljunemist
- libisemisvastased padjad

Maht 3x 14,5L
121.0494.192
47.- €

Maht 2x 14,5L + 2x 7,5L
121.0494.193
51.- €

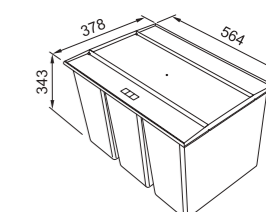

FX

Garbo

Easy Sort



50 cm



45 cm



MARIS

- 1
- 2
- 3
- 5
- 6
- 7
- 8



Garbo 50-3
 Aluskapp: **50 cm**
 Mõõdud: **462 x 399 x 360 mm**
 Sorteri tüüp: **esiuksega avatav**
 Paigaldamine: **kinnitatakse külgseinte külge**

Erimärkused:
 - metallist riiul mahutite kaanena
 - ukse reguleerimine küljelt
 - sujuv sulgumine
 - täielikult väljatulev, kandejõud 45 kg

Maht 2x 12L + 8L
 121.0200.691
171.- €

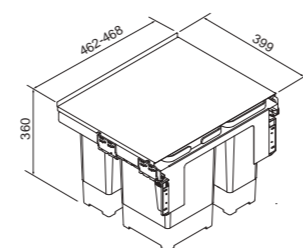

MARIS

- 2
- 4
- 6
- 8
- 9
- 10



Garbo 45-2
 Aluskapp: **45 cm**
 Mõõdud: **412 x 399 x 360 mm**
 Sorteri tüüp: **esiuksega avatav**
 Paigaldamine: **kinnitatakse külgseinte külge**

Erimärkused:
 - metallist riiul mahutite kaanena
 - ukse reguleerimine küljelt
 - sujuv sulgumine
 - täielikult väljatulev, kandejõud 45 kg

Maht 18L + 12L
 121.0200.692
165.- €

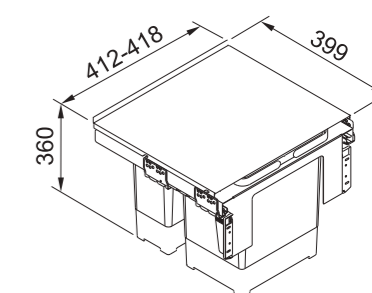

MARIS

- 15
- 16
- 17
- 19
- 20
- 21
- 22
- 23



Cube 50
 Aluskapp: **50 cm**
 Mõõdud: **470 x 330 x 345 mm**
 Sorteri tüüp: **küljele avaneva uksega avanev**
 Paigaldamine: **kapi põhjale kinnitatav**

Erimärkused:
 -Vajalik 110° avanevad uksehinged

Maht 18L + 14L
 134.0055.292
95.- €

Maht 14L + 2x 8L
 134.0055.293
98.- €

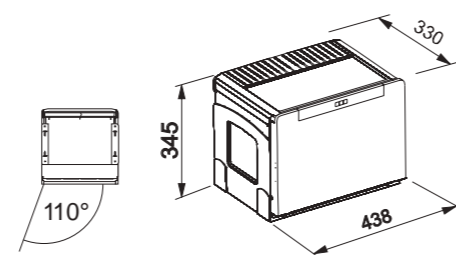

SMART



EASY SORT 45
 Aluskapp: **45 cm**
 Mõõdud: **414 x 378 x 343 mm**
 Sorteri tüüp: **sahtlisse paigaldatav**
 Paigaldamine: **kasutab köögikapi sahtlit**

Erimärkused:
 - toodetud taaskasutatud plastist
 - eriti tugev käepide (kuni 18 kg)
 - antiseptiline materjal takistab 99% bakterite paljunemist
 - libisemisvastased padjad

Maht 2x 14,5L
 121.0494.182
35.- €

Maht 14,5L + 2x 7,5L
 121.0494.150
40.- €

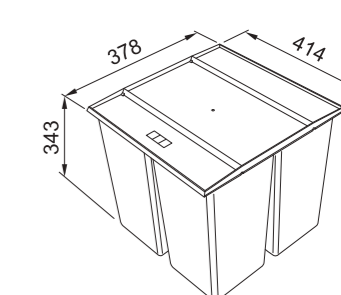

40 cm



30 cm

MARIS

- 15
- 18
- 20
- 22
- 23



Cube 40
 Aluskapp: **40 cm**
 Mõõdud: **335 x 407 x 348 mm**
 Sorteri tüüp: **küljele avaneva uksega avanev**
 Paigaldamine: **kapi põhjale kinnitatav**

Erimärkused:
 -Vajalik 110° avanevad uksehinged

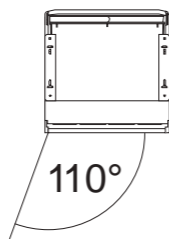

Maht 2x 14L
 134.0039.332
87.- €

Maht 14L + 2x 7L
 134.0039.331
90.- €

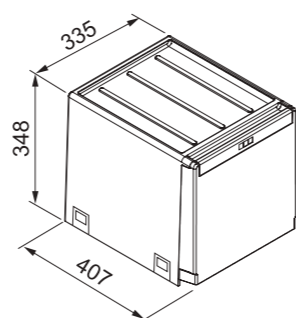

MARIS

- 12
- 13
- 14



Cube 30
 Aluskapp: **30 cm**
 Mõõdud: **253 x 467 x 433 mm**
 Sorteri tüüp: **Käitsi avatav (sorter ukse taga)**
 Paigaldamine: **kapi põhjale kinnitatav**

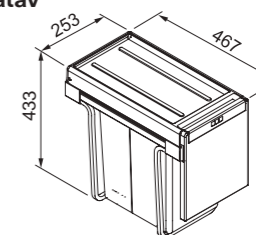

Maht 2x 15L
 134.0039.553
63.- €

Maht 20L + 10L
 134.0039.554
64.- €

Maht 3x 10L
 134.0039.555
68.- €

SMART



SORTER PIVOT
 Aluskapp: **40 cm**
 Mõõdud: **340 x 340 x 410 mm**
 Sorteri tüüp: **küljele avaneva uksega avanev**
 Paigaldamine: **kinnitatakse külge, universaalne**

Erimärkused:
 - plastist raam prügikottide kinnitamiseks
 - põhikapis tuleks kasutada amortisaatoritega hingesid
 - plastik riul prügikasti kaanena

Maht 27L
 121.0307.563
79.- €

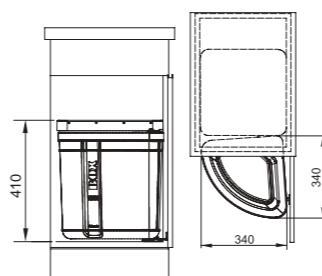

SMART



SORTER MINI
 Aluskapp: **40 cm**
 Mõõdud: **310 x 310 x 348 mm**
 Sorteri tüüp: **küljele avaneva uksega avanev**
 Paigaldamine: **kinnitatakse külge, universaalne**

Erimärkused:
 - plastist raam prügikottide kinnitamiseks
 - plastik riul prügikasti kaanena

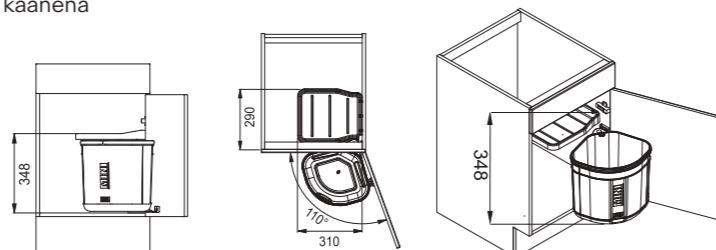

Täiendavad lisad sorteerimissüsteemidele

- | | | | | | | | |
|----|--|----|--|----|--|----|--|
| 1 | 133.0251.264
Sangaga plastikust jäätmemahuti 8 L
150 x 225 x 340 mm
16.- € | 2 | 133.0251.265
Sangaga plastikust jäätmemahuti 12 L
150 x 300 x 340 mm
18.- € | 3 | 133.0251.269
Sangaga plastikust jäätmemahuti 12 L
225 x 225 x 340 mm
18.- € | 4 | 133.0251.270
Sangaga plastikust jäätmemahuti 18 L
225 x 300 x 340 mm
19.- € |
| 5 | 133.0200.694
Plastikust kaas jäätmemahutile, antratsiit 8 L
8.- € | 6 | 133.0200.695
Plastikust kaas jäätmemahutile, antratsiit 12 L
10.- € | 7 | 133.0200.698
Aktiivsõefiltriga jäätmemahutile plastkaas 8 L
15.- € | 8 | 133.0200.699
Aktiivsõefiltriga jäätmemahutile plastkaas 12 L
20.- € |
| 9 | 133.0284.696
Plastikust kaas jäätmemahutile, antratsiit 18 L
10.- € | 10 | 133.0284.697
Aktiivsõefiltriga jäätmemahutile plastkaas 18 L
20.- € | 11 | 133.0251.271
Plastikust jäätmemahuti 125 x 165 x 75 mm
5.- € | 12 | 133.0042.702
Sangaga plastikust jäätmemahuti 20 L
230 x 295 x 365 mm
18.- € |
| 13 | 133.0042.696
Sangaga plastikust jäätmemahuti 15 L
230 x 220 x 365 mm
13.- € | 14 | 133.0042.678
Sangaga plastikust jäätmemahuti 10 L
230 x 150 x 365 mm
13.- € | 15 | 133.0023.966
Sangaga plastikust jäätmemahuti 14 L
315 x 185 x 290 mm
22.- € | 16 | 133.0016.358
Sangaga plastikust jäätmemahuti 18 L
310 x 220 x 290 mm
23.- € |
| 17 | 133.0016.359
Sangaga plastikust jäätmemahuti 8 L
220 x 160 x 290 mm
17.- € | 18 | 133.0039.556
Sangaga plastikust jäätmemahuti 7 L
150 x 180 x 290 mm
10.- € | 19 | 133.0014.739
Plastikust kaas jäätmemahutile, antratsiit 18 L
19.- € | 20 | 133.0014.278
Jäätmemahuti plastkaas 8 L
16.- € |
| 21 | 133.0016.354
Värvilised kilekottide hoidjad
3.- € | 22 | 134.0039.317
Cube 10 väljatõmmatav sahtel
93 x 407 x 348 mm
36.- € | | | | |

ELITE SLIM JÄÄTMEPU- RUSTAJAD



Tänu uutele Franke Elite Slimline jäätmepurustajatele on pärast sööki koristamine sama lihtne kui toiduvalmistamine. Need on loodud perede abistamiseks nende igapäevaste toimetuste tegemisel. Toidujäätmeid purustades ja utiliseerides vähendate bakterite ja lõhnade ohtu köögis, samuti jätkusuutlikum lähenemine oma igapäevasele köögitüübile.



Tugev jõudlus

Tänu uuenduslikule Twist Force tehnoloogiale, mis pakub suurepärase purustusjõudu, võite oodata kiireid ja tõhusaid tulemusi ilma masinat segamata. Hügieeniline kaitsekate võitleb ka bakterite kasvu ja ebameeldiva lõhna vastu, mida pakub antibakteriaalne kaitse.

Veenvad detailid

Igal jäätmepurustil on kummist pritsmekaitse, mis tagab, et soovimatud esemed ei satuks purustamiskambrisse. Müra kõrvaldatakse heli summutustehnoloogia abil. Teatud mudelite tugev magnetkaar tagab, et metallist esemed ei satuks purustuskambrisse.



Elegantsus valamu all

3 poldi kinnitussüsteemiga, mis muudab selle ühilduvaks kõigi Franke valamutega, millel on 3 1/2 tolline ventiil, ja elegantne korpus, mis on loodud rohkem ruumi säästma valamu all on iga Elite Slimline jäätmepurustaja näide Franke uuendusest, mis on kena täiendus igasse kööki.



ELITE SLIM

MARIS

- 1 6
- 2 7
- 3 8
- 4 9
- 5 10

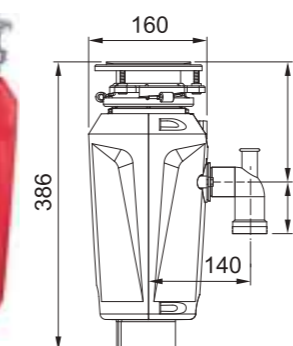

Võimsus: 1,25 hj
Keerutamine: pidev ühesuunaline
Pööret minutis: 2800
Heli neelav korpus
Roostevabast terasest purustuskamber
Twist Force tasakaalustatud purustussüsteem
Vastupidav kinnikiilumisele
Massiivsed metallist purustuselemendid
Eemaldatav antibakteriaalne pritsmekaitse
Magnetrõngas kaitseks metalli eest teemasid
3 kruviga kinnitus
Integreeritud õhulüliti koos ühendustoruga

Slim 125
1.25 HP
Jäätmepurustajad
134.0715.094
300.- €

MARIS

- 1 6
- 2 7
- 3 8
- 4 9
- 5 10

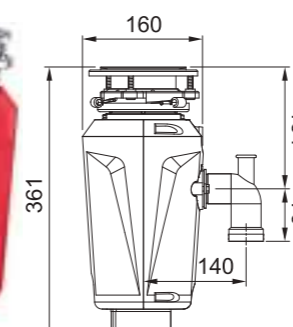

Võimsus: 0,75 hj
Keerutamine: pidev ühesuunaline
Pööret minutis: 2800
Heli neelav korpus
Roostevabast terasest purustuskamber
Twist Force tasakaalustatud purustussüsteem
Vastupidav kinnikiilumisele
Massiivsed metallist purustuselemendid
Eemaldatav antibakteriaalne pritsmekaitse
3 kruviga kinnitus
Integreeritud õhulüliti koos ühendustoruga

Slim 75
0.75 HP
Jäätmepurustajad
134.0715.096
254.- €

MARIS

- 1 6
- 2 7
- 3 8
- 4 9
- 5 10

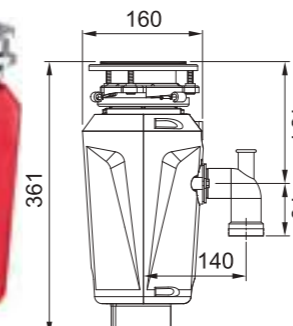

Võimsus: 0,5 hj
Keerutamine: pidev ühesuunaline
Pööret minutis: 2800
Heli neelav korpus
Roostevabast terasest purustuskamber
Twist Force tasakaalustatud purustussüsteem
Vastupidav kinnikiilumisele
Massiivsed metallist purustuselemendid
Eemaldatav antibakteriaalne pritsmekaitse
3 kruviga kinnitus
Integreeritud õhulüliti koos ühendustoruga

Slim 50
0.5 HP
Jäätmepurustajad
134.0715.098
208.- €

Lisad



112.0277.144
Universaalne Ülevoolu
ühenduskomplekt
26.- €



112.0674.415
Mustad nupud jäätmepurusti
juhtimiseks
25.- €

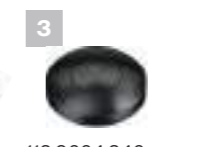

112.0664.346
Nupud jäätmepurusti
juhtimiseks - Antratsiit
20.- €

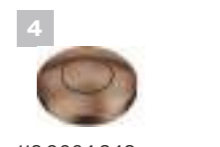

112.0664.348
Nupud jäätmepurusti
juhtimiseks - vask
20.- €

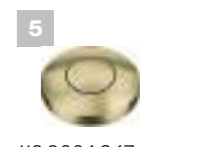

112.0664.347
Nupud jäätmepurusti
juhtimiseks - Šampan-
jakuldne
20.- €



112.0664.350
Jäätmete kogumisventiili
rõngas koos kaanega -
Antratsiit
38.- €



112.0664.394
Jäätmete kogumisventiili
rõngas koos kaanega -
Antratsiit
38.- €



112.0664.391
Jäätmete kogumisventiili
rõngas koos kaanega - Šam-
panjakuldne
38.- €



112.0657.421
Võrkkorviga prügipurusti
klapirõngas - Must matt
35.- €



112.0489.809
Keraamiliste valamute jaoks
mõeldud jäätmepurustaja
kinnituse pikendus
17.- €

Izlietņu ventīļu komplektācija

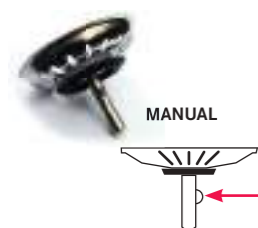

133.0005.681
Põhjasõel 3½" - käsitsi avatav
13.- €



133.0008.411
Põhjasõel 3½" - käsitsi avatav
13.- €



133.0049.669
Põhjasõel integreeritud ventiilile 3½" - käsitsi avatav
11.- €



133.0272.273
Silindriline köögisegisti kinnitusvõti 38 mm. Pikkus 196 mm
9.- €

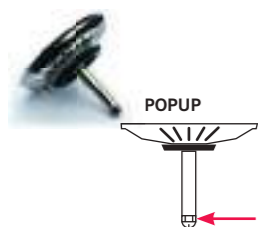

133.0005.611
Põhjasõel 3½" - nupuga avatav
14.- €



133.0049.668
Põhjasõel integreeritud ventiilile 3½" -nupuga avatav
12.- €



133.0172.724
Pudel Novita seebidosaatorile 300 ml
14.- €



112.0473.656
Augufrees 35mm Fragranit ja Tectonite valamutele
5.- €



112.0008.476
Augu 35mm jaoks
44.- €



112.0006.333
Roostevabast terasest valamute käsifrees 35 mm augu jaoks
3.- €



112.0085.384
Roostevabast terasest valamute kinnituskomplekt kleebise ja tihendiga
5.- €



133.0336.625
Ühendustoru 105 mm
3.- €

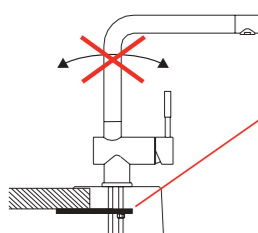

133.0026.896
Segisti kinnitus roostevabast terasest valamute jaoks. Takistab segisti liikumist. Reguleeritav.
13.- €



133.0297.561
Mudafilter, lihtne hooldada, ¾" ühendusega (2 tk)
36.- €



133.0006.405
Ühendus suure ja väikese kausi jaoks 1½"
9.- €



112.0705.730
Ümar vajutusnupp roostevabast terasest
69.- €



112.0657.770
Ühendus sifooni 1½" jaoks
8.- €



112.0006.412
Universaalne ruumisäästlik sifoon 1½" 1 m
7.- €



112.0006.456
Painduva ühendusega sifoon 1½"
12.- €



133.0459.872
Kaetud ülevool katteplaadi ja teleskoopse ühendusega
24.- €



133.0173.094
Kaetud ülevool katteplaadi ja teleskoopse ühendusega
33.- €



133.0254.554
Kaetud ülevool katteplaadi ja teleskoopse ühendusega
13.- €



133.0254.556
Kaetud ülevool katteplaadi ja teleskoopse ühendusega
11.- €



133.0036.506
Kaetud ülevool katteplaadi ja teleskoopse ühendusega
33.- €



133.0459.871
Kaetud ülevool katteplaadi ja teleskoopse ühendusega
24.- €



112.0657.146
Must klapi kate on mõeldud Maris sarja üheosalistele valamute valamud
11.- €



112.0658.197
Klapi komplekt klapi juhtnupuga, must ümmargune ülevool, must nupp sulgemiseks ja avamiseks
73.- €



112.0658.446
Klapi komplekti klapi juhtimine nupuga, musta nurga ülevool, must nupp sulgemiseks ja avamiseks
68.- €



112.0658.280
Klapi komplekt koos klapi juhtimisega kaks kausi valamute, must ümmargune ülevool, must nupp
86.- €



112.0658.444
Klapi komplekt käsitsi ventiiliga musta nurga ülevooluga
37.- €



112.0532.169
Roostevabast terasest klapi kate. Kavas on Mythos, Box Center ja Maris ühekaulised valamud.
10.- €



112.0653.030
Antratsiit ventiil 3½" käsijuhtimisega (ventiil 3½" ülevooluga)
270.- €



112.0652.898
Šampanjakuldne ventiil 3½" käsijuhtimisega (ventiil 3½" ülevooluga)
270.- €

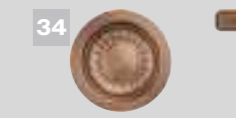

112.0652.978
Vask ventiil 3½" käsijuhtimisega (ventiil 3½" ülevooluga)
270.- €

Klapi komplektid on mõeldud olemasolevate ventiilide väljavahetamiseks, et muuta valamute värvilisemaks ja segistiga kokkusobivamaks.



112.0395.171
Nelinurkne ventiil kate roostevabast terasest
125 x 125 mm
8.- €



112.0653.035
Antratsiit 3½" ektsentventiil (ventiil 3½", ülevooluga, ümar vajutusnupp)
338.- €



112.0653.036
Šampanjakuldne 3½" ektsentventiil (ventiil 3½", ülevooluga, ümar vajutusnupp)
338.- €



112.0653.041
Vask 3½" ektsentventiil (ventiil 3½", ülevooluga, ümar vajutusnupp)
338.- €



112.0366.355
Nupuluku tugi
46.- €



112.0301.673
3½" ektsentventiil (nupuga avatav)
47.- €



112.0389.090
3½" ektsentventiil (nupuga avatav)
47.- €



112.0331.953
3½" ektsentventiil (nupuga avatav)
35.- €



112.0331.971
3½" ektsentventiil (nupuga avatav)
35.- €



112.0307.599
Ventiil 3½" käsijuhtimisega
18.- €



112.0049.409
Ventiil 3½" käsijuhtimisega
19.- €



112.0307.597
Ventiil 3½" käsijuhtimisega
14.- €



133.0395.082
Ventiil 1½" käsitsi juhtimisega väikese kausi jaoks
35.- €



133.0395.083
Ventiil 1½" käsitsi juhtimisega väikese kausi jaoks
35.- €



Valamu ja segisti puhastusvahendid

<p>112.0007.125 Franke Twister käsnaga 125 ml 7.- €</p>	<p>x12 112.0007.459 Franke Twister käsnaga komplektis karbis 12x 125 ml 83.- €</p>	<p>112.0007.712 Franke Maratoni lubjavastane, komplekt 3 pudeliga 44.- €</p>	<p>112.0530.324 HOOLDUSVAHEND mikrok- iust lapp 10.- €</p>
<p>112.0579.123 HOOLDUSVAHEND Värvilised valamud 250 ml 13.- €</p>	<p>112.0579.124 HOOLDUSVAHEND Segistite jaoks 250 ml 13.- €</p>	<p>112.0530.240 HOOLDUSVAHEND Öhupuhastite jaoks 250 ml 13.- €</p>	<p>112.0304.193 Puhastuskäsna komplekt 4.- €</p>

Kuidas teha auk Franke Fraganite valamusse?

Te vajate: Teemantfreesi läbimõõduga Ø 35 mm segisti ja nupu augu puurimiseks Artikkel 112.0473.656 € 5,00

Enne valamu paigaldamist tööpinna asetage valamu tagurpidi kindlale pinnale.

Akutrelli otsa paigaldatud augufreesiga freesige et-tefreesitud auk lõpuni.

Kui auk on puuritud, puhastage augu servad.

Paigaldage segisti ja põhjasõela nupp.



Ikoonide selgitused

- Aluskapi laius
 - Vajutusnupp: Põhjasõela avamine ja sulgemine vajutusnupuga. Vee väljavool on avatud, kui nupp on valamuga ühes tasapinnas.
 - Pöördnupp: põhjasõela avamine ja sulgemine pöördnupuga.
 - Käsitsi: käega põhjasõela kergitamiseks avatakse vee väljavool ja põhjasõela vajutamiseks suletakse vee väljavool. Ei ole vaja teha täiendavat auku valamusse ega ka tööpinda.
 - Tõstenupp: põhjasõela avamine ja sulgemine tõstenupuga.
- Kahepoolne valamu.
- Integreeritud äravool: väljavoolu ülemine osa on pressitud valamu põhja. Nii on valamu põhi täiesti sile ilma tihenditeta, seega väga hügeeniline. Ei sobi jäätme-purustaja paigaldamiseks.
- Jäätmepurustaja ühendamine on võimalik
- Süvistatav
- Tasapinnaline
- SlimTop valamu.
- Altpoolt monteeritav



Segistite

- Kangsegisti: segistil on jäik otsik st ilma väljatõmmatava voolikuta.
- Väljatõmmatava voolikuga: Segistil on väljatõmmatav voolik. Otsikul on tavaline juga.
- Kuulühendus. Veetoru ei saa tänu kuulühendusele pöörelda ning toimib liikuva üleminekuna veetoru ja väljatõmmatava otsaku vahel. Väljalaskevooliku vahetamine on nüüd veelgi lihtsam.
- Laminaarse voolu aeraator eraldab vähem pritsmeid
- Akna ette monteeritav: ideaalne akna ette paigaldamiseks. Segistit saab akna avamisel maha painutada või mõnedel mudelitel tööpinna sisse suruda.
- Pöördeulatus: näitab kui suures ulatuses on võimalik jooksutoru pöörata.
- Kang mõlemal küljel: võimalik on monteerida kang paremal või vasakul.
- Kang keskel: Segistil on kang üleval.
- Kang paremal: Segisti saab monteerida ainult kang paremal.



FRANKE TOOTE KATALOOG sisaldab informatsiooni praeguse tootevaliku kohta. Kommentaarid toodete saadavuse kohta on toodetel mis tulevikus asendatakse teiste sarnaste ja täiustatud toodetega ning uute artiklinumbritega. Toodete saadavuse kohta pärast ette antud tähtaegu, palun kontakteeruge Franke ametlike maaletoojatega.

Tähelepanu! Hinnad on soovituslikud jaehinnad ja sisaldavad käibemaksu 22%. Tootepildid on illustratiivsed, näiteks toode ei tarvitse sisaldada pildil toodud nõrutuskausi (jälgige alati tootekirjeldust!). Valamul ja segistil võivad võrreldes tootenäidistega esineda tehnoloogias tulenevat värvierinevust. Tehniliste uuenduste tõttu võivad tooted erineda kataloogis toodud toodetest. Franke ei võta endale vastutust kataloogis esinevate eksimuste, näiteks trükivigade eest. Kõigile toodetele kehtib garantii 2 aastat juhul, kui on järgitud paigaldus- ja kasutusjuhendit.

Garantiitööd, remont ja varuosad:
Eliser OÜ
Mustamäe tee 24,
Tallinn
teenindus@eliser.ee
tel: 6650090

INTERNET
Kõige värskema info saab alati leida www.franke.ee/ks

YOUTUBE
Vaata meid youtube kanalis www.youtube.com/user/Franke-KitchenSystem

KATALOOG
Kataloogi ja muud materjalid PDF-formaadis saab alla laadida www.franke.ee/ks peatükkides abi/brošüürid

Franke art.nr. registrid

Art.Nr.	Lk.	Art.Nr.	Lk.	Art.Nr.	Lk.	Art.Nr.	Lk.	Art.Nr.	Lk.	Art.Nr.	Lk.	Art.Nr.	Lk.	Art.Nr.	Lk.	Art.Nr.	Lk.	Art.Nr.	Lk.
101		112.0579.123	192	114.0199.718	87	114.0658.140	73	114.0682.567	76	115.0595.081	64, 66, 74, 76, 78, 169	115.0668.381	177	124		126		133.0200.699	187
101.0085.772	54	112.0579.124	192	114.0253.322	67	114.0658.216	73	114.0682.569	76	115.0595.083	169	115.0668.382	177	124.0335.706	101	126.0335.711	135	133.0251.264	187
101.0085.773	54	112.0591.081	36, 109	114.0253.323	67	114.0658.217	73	114.0682.570	76	115.0595.088	169	115.0668.383	177	124.0335.707	100	126.0335.712	135	133.0251.265	187
101.0463.814	56	112.0591.082	36, 109	114.0253.324	67	114.0658.218	73	114.0682.600	77	115.0595.089	169	115.0681.241	154	124.0335.708	100	126.0335.714	134	133.0251.269	187
101.0464.044	50	112.0595.334	51, 53, 54, 56, 66, 74, 76, 78, 80, 82, 92, 94	114.0253.333	65	114.0658.219	73	114.0682.641	77	115.0595.091	169	115.0681.242	154	124.0335.709	99	126.0335.875	135	133.0251.270	187
101.0464.337	50			114.0253.334	65	114.0658.220	73	114.0682.642	77	115.0595.093	169	115.0681.243	157	124.0335.710	99	126.0335.878	135	133.0251.271	187
101.0469.740	53			114.0253.335	65	114.0658.254	73	114.0682.643	77	115.0596.320	151	115.0681.244	157	124.0335.844	101	126.0335.880	135	133.0254.554	190
101.0498.889	55			114.0256.609	83	114.0658.255	73	114.0682.644	77	115.0690.598	162	115.0690.598	162	124.0335.851	101	126.0335.883	135	133.0254.556	190
101.0554.878	51	112.0602.288	36, 109	114.0256.610	83	114.0658.256	73	114.0682.737	76	115.0693.228	172	115.0693.229	173	124.0335.856	100	126.0335.887	134	133.0272.273	190
101.0622.893	49	112.0619.946	40, 42, 112, 114	114.0256.611	83	114.0658.257	73	114.0682.738	77	115.0600.095	168	115.0693.230	175	124.0335.863	100	126.0380.348	134	133.0284.025	145
101.0714.948	52			114.0256.612	83	114.0658.293	71	114.0700.628	87	115.0600.098	168	115.0693.393	175	124.0335.868	99	126.0380.350	135	133.0284.026	145
101.0714.950	53	112.0652.898	191	114.0256.624	81	114.0658.294	71	114.0715.513	79	115.0613.590	157	115.0693.393	175	124.0335.872	99	126.0380.352	135	133.0284.696	187
101.0714.951	53	112.0652.978	191	114.0256.625	81	114.0658.295	71	114.0715.514	79	115.0613.671	157	115.0706.985	159	124.0335.874	100	126.0380.352	135	133.0284.697	187
101.0714.957	52	112.0653.030	191	114.0256.626	81	114.0658.296	71	114.0715.515	79	115.0621.592	168	115.0706.986	159	124.0380.247	100	126.0381.439	135	133.0297.561	190
101.0714.971	57	112.0653.035	191	114.0256.627	81	114.0658.297	71	114.0715.518	69	115.0621.613	168	115.0707.619	176	124.0380.248	100	126.0381.512	135	133.0297.561	190
101.0714.972	57	112.0653.036	191	114.0301.331	83	114.0658.298	71	114.0715.519	71	115.0623.054	170	115.0711.554	147	124.0380.250	101	126.0381.518	135	133.0336.625	190
101.0725.057	57	112.0653.041	191	114.0301.333	83	114.0658.299	71	114.0715.520	71	115.0623.054	170	115.0711.555	147	125.0512.449	123	127.0372.488	41, 113	133.0395.082	191
101.0727.747	56	112.0654.748	122	114.0301.335	83	114.0658.300	71	114.0715.521	73	115.0623.055	170	115.0711.555	147	125.0512.450	123	127.0372.489	41, 113	133.0395.083	191
101.0729.488	52	112.0655.239	34, 106	114.0301.342	83	114.0658.301	71	114.0715.522	73	115.0623.056	170	115.0711.557	147	125.0512.451	123	127.0372.501	43, 115	133.0459.871	190
101.0729.489	51	112.0655.240	34, 106	114.0301.345	81	114.0658.302	71	114.0723.957	83	115.0623.057	84, 170	115.0711.558	147	125.0512.452	123	127.0372.501	43, 115	133.0459.872	190
101.0729.490	51	112.0655.341	34, 106	114.0301.367	81	114.0658.310	69	114.0723.958	83	115.0623.135	170	115.0712.420	175	125.0512.452	123	127.0374.206	41, 113	134	
101.0729.492	51	112.0655.342	34, 106	114.0301.368	81	114.0658.310	69	114.0723.958	83	115.0623.137	170	115.0712.435	175	125.0512.504	123	127.0374.673	43, 115	134.0039.317	187
101.0729.493	52	112.0655.343	34, 106	114.0301.370	81	114.0658.331	69	114.0723.959	81	115.0623.139	170	115.0721.463	167	125.0512.505	123	127.0374.687	42, 115	134.0039.331	186
101.0734.373	57	112.0655.344	34, 106	114.0301.373	83	114.0658.332	69	114.0723.961	81	115.0623.140	170	115.0721.464	167	125.0512.506	123	127.0375.252	42, 114	134.0039.332	186
112		112.0655.431	34, 106	114.0301.903	83	114.0658.333	69	114.0723.963	63	115.0623.141	170	115.0725.838	173	125.0512.507	123	127.0375.257	41, 113	134.0039.553	187
112.0006.138	53	112.0655.433	34, 106	114.0301.907	83	114.0658.334	69	114.0723.964	63	115.0623.146	170	115.0728.473	174	125.0512.515	123	127.0375.273	41, 113	134.0039.554	187
112.0006.333	190	112.0655.468	34, 106	114.0301.951	81	114.0658.417	72	114.0723.965	87	115.0623.147	170	115.0728.474	174	125.0627.319	123	127.0375.278	41, 113	134.0039.555	187
112.0006.412	55, 190	112.0655.470	34, 106	114.0301.961	81	114.0658.418	72	114.0723.966	77	115.0625.185	163	115.0728.476	174	125.0627.320	123	127.0375.284	42, 114	134.0055.292	184
112.0006.456	190	112.0655.471	34, 106	114.0302.018	83	114.0658.419	70	114.0723.968	77	115.0625.187	163	115.0728.477	174	125.0627.321	123	127.0476.450	48	134.0055.293	184
112.0007.459	192	112.0655.472	34, 106	114.0302.676	65	114.0658.494	70	114.0723.968	77	115.0625.188	163	115.0728.478	175	125.0683.056	127	127.0476.541	48	134.0715.094	189
112.0007.712	192	112.0655.481	137	114.0302.683	65	114.0658.495	70	114.0723.969	75	115.0625.190	163	115.0728.479	175	125.0683.057	127	127.0531.809	47	134.0715.096	189
112.0007.715	192	112.0655.482	137	114.0302.693	66	114.0658.496	70	114.0723.970	76	115.0625.489	153	115.0728.480	175	125.0683.058	127	127.0531.810	47	134.0715.098	189
112.0008.476	190	112.0655.483	137	114.0302.705	67	114.0658.497	70	114.0723.972	83	115.0625.523	153	115.0728.484	175	125.0683.059	127	127.0531.851	45	135	
112.0017.900	62	112.0655.488	137	114.0302.708	67	114.0658.498	70	114.0723.973	81	115.0625.525	153	115.0728.485	175	125.0683.060	127	127.0531.852	45	135.0682.982	133
112.0018.817	62	112.0655.489	137	114.0302.751	85	114.0658.583	73	114.0723.974	85	115.0625.527	153	115.0728.486	175	125.0683.101	125	127.0531.915	47	135.0682.983	133
112.0030.882	44, 46, 68, 70, 72, 100, 116, 118, 124, 126, 128, 131, 133, 191	112.0657.146	68, 70, 72, 124, 126, 128, 131, 133, 191	114.0302.757	85	114.0658.586	71	114.0723.975	87	115.0626.019	172	119		125.0683.102	125	127.0531.916	46	135.0682.984	133
		112.0657.421	189	114.0303.666	85	114.0658.588	69	114.0723.976	77	115.0626.020	172	119.0150.262	179	125.0683.103	125	127.0531.917	45	135.0682.985	133
		112.0657.770	190	114.0303.670	85	114.0659.123	73	114.0723.978	85	115.0626.022	172	119.0155.993	179	125.0683.104	125	127.0531.917	45	135.0682.986	133
		112.0658.197	191	114.0303.671	85	114.0659.124	71	114.0723.979	85	115.0626.024	172	119.0177.893	179	125.0683.105	125	127.0539.907	40, 112	135.0683.023	131
		112.0658.280	191	114.0303.672	85	114.0659.125	69	115.0028.205	176	115.0626.026	172	119.0547.902	178	125.0683.135	127	127.0539.907	40, 112	135.0683.024	131
		112.0658.444	191	114.0316.526	87	114.0681.426	79	115.0028.208	176	115.0626.028	172	119.0547.905	178	125.0683.136	127	127.0553.961	47	135.0683.024	131
		112.0658.444	191	114.0316.528	87	114.0681.427	79	115.0060.360	176	115.0626.028	172	119.0547.906	178	125.0683.136	127	127.0558.824	39	135.0683.025	131
		112.0658.446	191	114.0336.914	81	114.0681.428	79	115.0347.111	171	115.0626.053	173	119.0547.906	178	125.0683.137	127	127.0558.826	39	135.0683.026	131
		112.0659.398	36, 109	114.0336.916	81	114.0681.429	79	115.0626.055	173	115.0626.053	173	119.0547.906	178	125.0683.138	127	127.0603.543	37	135.0683.027	131
		112.0664.346	189	114.0336.936	81	114.0681.430	79	115.0626.057	173	115.0626.053	173	119.0578.743	179	125.0683.138	127	127.0603.544	37	135.0683.034	132
		112.0664.347	189	114.0336.939	81	114.0681.431	79	115.0626.081	173	115.0626.084	173	119.0578.744	179	125.0683.139	127	127.0603.544	37	135.0683.034	132
		112.0664.348	189	114.0368.449	94	114.0681.581	79	115.0626.081	173	115.0626.084	173	119.0578.745	179	125.0683.140	125	127.0603.546	36	135.0683.035	132
		112.0664.350	189	114.0368.467	94	114.0681.583	79	115.0626.083	173	115.0626.084	173	119.0578.748	179	125.0683.140	125	127.0625.054	37	135.0683.036	132
		112.0664.391	189	114.0378.095	65	114.0681.584	79	115.0626.084	173	115.0626.085	172	119.0578.750	179	125.0683.182	125	127.0625.062	35, 107	13	



FRANKE

FRANKE GmbH
Mumpferfährstraße 70
79713
Bad Säckingen
Deutschland
www.franke.de
www.franke.de/ks

Eesti
www.franke.ee/ks