



RONDO-100 / RONDO-125

Frameless ventilation diffuser

Technical specification



reddot winner 2023

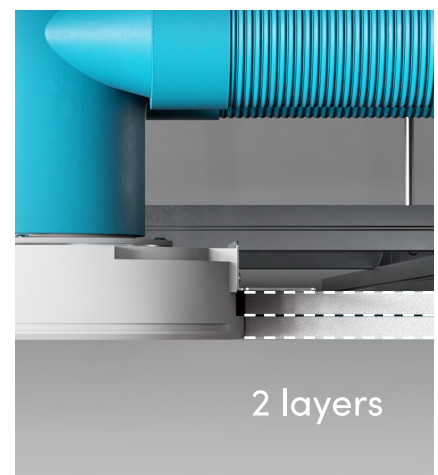
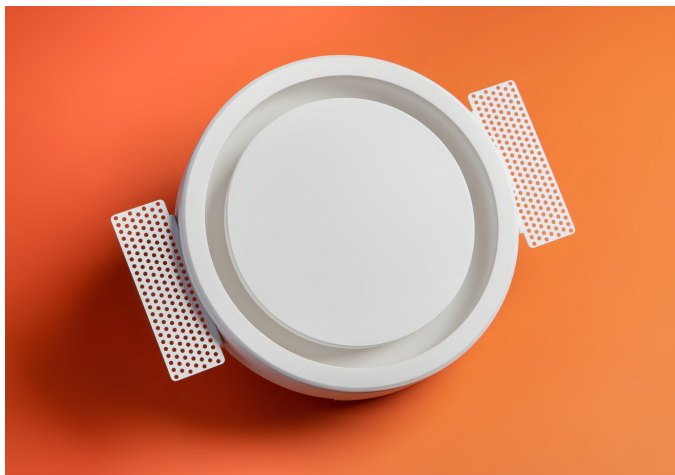
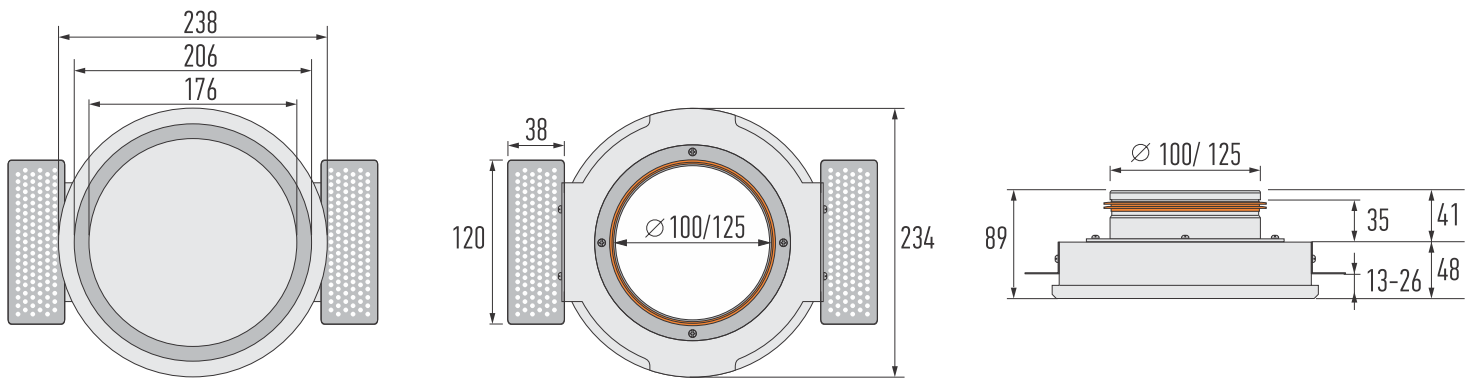

RONDO-100 / 125

Technical data



frameless
air diffusers

RONDO 100 (supply air)

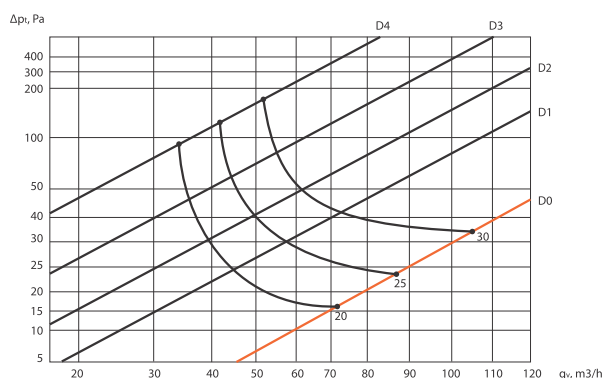

RONDO 125 (supply air)

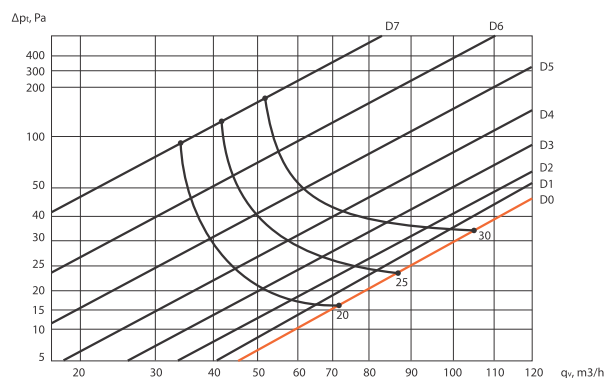

RONDO 100 (exhaust air)

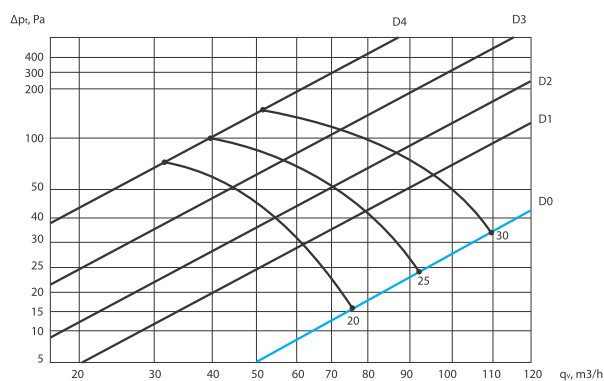

RONDO 125 (exhaust air)

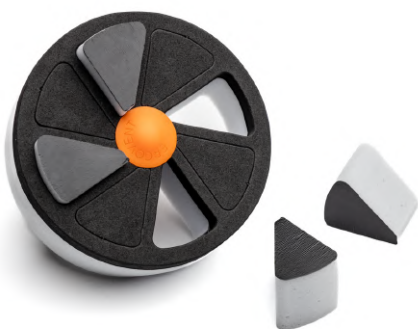
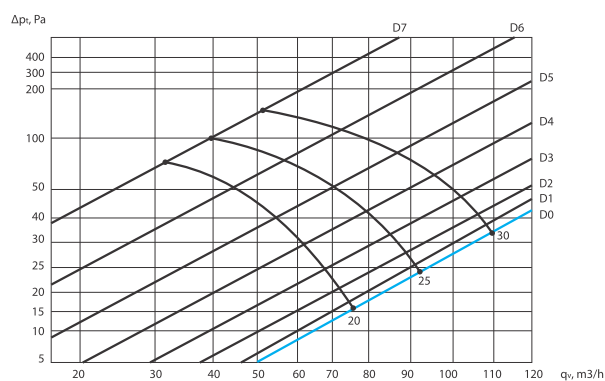

Polyurethane dampers are used to adjust the airflow.

- D0 – no damper inserted
- D1 – 1 segment inserted
- D2 – 2 segments inserted
- D3 – 3 segments inserted
- D4 – 4 segments inserted
- D5 – 5 segments inserted
- D6 – 6 segments inserted
- D7 – 7 segments inserted

RONDO 100/125
velocity, m/s

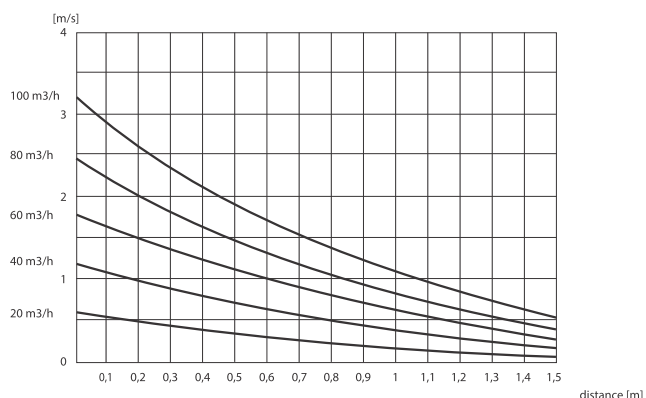

Scan QR code to download the installation instructions.